



2020 H1

PRO & VALUE SERIES QUICK GUIDE



ABOUT HIKVISION

It started with cutting-edge technology: high-definition IP cameras, digital video servers, hybrid and standalone DVRs, NVRs, speed domes, encoders and decoders. And momentum continues to develop new technologies for a safer future.

Strengthened by one of the largest R&D teams in the video surveillance industry, the innovation behind these products quickly made Hikvision the #1 CCTV and video surveillance equipment provider in the world (2017 IHS Report). A total solution provider, Hikvision manufactures a full suite of video surveillance products and solutions for a broad range of vertical markets, including retail, education, and many others. Whatever the scope or requirements of the application, Hikvision has a user-friendly, highly scalable product to meet those needs.

HIKVISION UNAUTHORIZED DISTRIBUTORS POLICY

Hikvision Europe sells products only through authorized distributors. We value our industry partners and are proud of the relationships we have developed to help expand the use of our innovative technology products and solutions. These authorized distributors have committed to serve as a link in the Hikvision Europe value chain by providing excellent pre- and post-sale customer service, including full firmware and sales engineering support.

Not every distributor advertising Hikvision products has been authorized by Hikvision Europe to advertise or sell those products. We warn potential customers against purchasing these "gray market" products from unauthorized distributors. Unauthorized distributors may be selling counterfeit, used, or damaged product. Much of the products sold by unauthorized distributors have been altered with modified firmware. Since this means that it is no longer in original factory condition, Hikvision warranty is void, per company policy.

We warn potential customers against purchasing from unauthorized distributors. Purchasing through authorized Hikvision Europe distributors ensures that you receive the benefits of technical support, project registration, dealer loyalty programs and advance replacement of any camera, recorder, monitor, video server, or software, in addition to Hikvision Europe full warranty. Additionally, products purchased through authorized distribution partners have additional features and capabilities that distinguish the Europe offering.

If you have any questions or concerns about the official status of your Hikvision distributor before your purchase, please contact Hikvision Europe Customer Service at support.eu@hikvision.com to confirm their authorized status.

Thank you for your continued support of our industryleading video surveillance products.

CONTENTS

01 IP CAMERAS	9 - 24	06 NETWORK VIDEO RECORDERS	55 - 60	11 DISPLAYS & SWITCHES	120 - 129
Pro Series Value Series		Pro Series Value Series			
02 TURBO HD CAMERAS	25 - 42	07 DIGITAL VIDEO RECORDERS	61 - 69	12 BRACKET	130 - 165
Pro Series Value Series		Pro Series Value Series			
03 IP PTZ CAMERAS	43 - 47	08 ACCESS CONTROL	70 - 108		
Pro Series Value Series					
04 TURBO HD PTZ CAMERAS	48 - 59	09 SECURITY RADAR	109 - 110		
05 THERMAL SECURITY CAMERAS	50 - 54	10 ALARM	111 - 119		
Thermal turret camera Single Bullet Camera Bi-Spectrum Bullet Camera					



DEALER PARTNER PROGRAM CAPITALISING PROJECT OPPORTUNITIES



* For further informations, please contact your distributor



GREATER PARTNERSHIPS

Hikvision is pleased to introduce an exclusive, invitation-only Partner Program. We are committed to investing in our installer partners with a focus on capitalization of project opportunities. Partner with Hikvision and leverage our unique market position as the leading video product manufacturer in the world, while gaining the benefits of an invitation-only program.

From inside sales to engineering support, from customer service to technical support, Hikvision goes the extra mile to provide customers with all of the elements they need for a first-class security system. Hikvision's Dealer Partner Program provides additional resources for dealers to help promote business success through knowledge and valuable tools. Hikvision is committed to protecting and creating business value for its customers.

To learn more about the program, please contact us at partners.eu@hikvision.com

VERTICAL MARKET FOCUS

For a complete overview of all verticals, please visit www.hikvision.com

TRANSPORTATION

Hikvision offers a wide assortment of solutions to meet the needs of transport hubs, roads, highways, and more. Effects of exhaust, sand, winter salt, snow, sleet and high winds are not an issue for Hikvision cameras, which are highly rated and made to resist severe outdoor conditions.

HEALTHCARE

Patient monitoring, emergency rooms, pharmacies, speciality departments, and restricted areas are all critical zones that require reliable security equipment. Just as we all depend on our physician to keep us well, we can depend on Hikvision's solutions to ensure the security of healthcare facilities.

EDUCATION

Protection of loved ones is one of Hikvision's highest priorities. Budget-minded school districts find Hikvision's product selection unmatched in the industry. High resolution cameras offer excellent image quality for a market-leading price. Image enhancements, such as wide dynamic range and high definition video, make our products well suited to capture remarkable detail in exterior and interior settings.

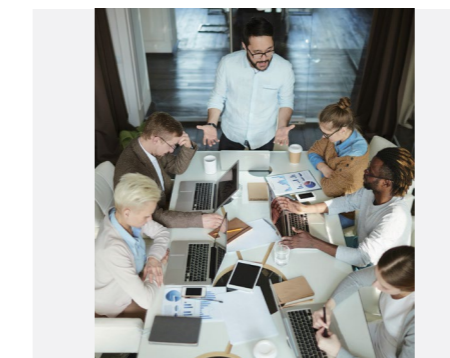

RETAIL

Shop and restaurant owners have peace of mind when using Hikvision's high performing products, which are aesthetically pleasing to boot. In each camera category are compact bullet, turret, dome and covert varieties, which provide discreet surveillance in attractive packaging. POS integration, heat mapping, and special counting cameras provide significant business management information. Data collected can then be managed through Hikvision's smart recording equipment.

GOVERNMENT

With strained budgets and changing priorities, safety remains an important issue for government facilities. Significant upgrades to existing analogue infrastructures are possible using our TurboHD™ line of HD-TVI solutions, which deliver HD analogue video without the high costs of networked systems.

SAFE CITIES

Hikvision is dedicated to helping solve public safety issues by providing surveillance systems that address emergency response, disaster management, and overall public safety. A key responsibility of any city is to ensure the safety of its citizens.



CRITICAL INFRASTRUCTURE

Hikvision's Smart Series and Speciality cameras offer performance and features that are ideal for critical security installations. Resolutions of 12 MP, 8 MP (4K), 6 MP and more deliver detailed video images. DarkFighter and Lightfighter solutions provide clear images in any lighting condition. Stainless-steel, high impact and weather-rated cameras withstand harsh environments. Built-in smart analytics provide pre- and post-event details. Data recording and storage products keep records safe and ready for forensic research. Every critical infrastructure setting has its own set of needs, and with Hikvision products, and these needs are all met.



ColorVu

Colorful Imaging
24/7

VIEW IN COLOR, EVEN IN DARKNESS

ENJOY VIVID COLOR IMAGES ROUND-THE-CLOCK WITH
COLORVU TECHNOLOGY

- **Advanced Lenses**

F1.0 Super-aperture collects more light to produce brighter images

- **High Performance Sensors**

Advanced sensor technology can vastly improve the utilization of available light

- **Friendly Lighting**

In zero-light scenarios, built-in, environmental-friendly, soft and warm supplemental lighting works to guarantee colorful images

HIKVISION

TWO SERIES FOR MAXIMUM FLEXIBILITY

At Hikvision we want to provide the most flexible range of products to fit any solution. Our IP camera, Turbo HD cameras, NVRs and DVRs are offered in two series – Value and Professional.

Value

The Value series is designed to be a cost-effective range, providing easy installation and reliable technology that gets the job done. These are the 'workhorses' of surveillance, delivering core benefits, like clear images, H.264/H.265 compression, IP66 or IP67 protection.

Pro

The Pro series offers more features, when a higher level of features is needed, making the solution more powerful. Among other things, these products add a number of extra features to the core product:

For cameras:

Low-light technology gives cameras the ability to see through the darkness, delivering bright images even in environments from 0.05 to 0.001 lux. All products in this series also include WDR, which helps them to handle very bright environments.

Higher resolution makes images sharper and monitoring easier.

For Recorders:

Larger housings give room for more functions, like alarm and audio monitoring. These products also include HD slots, to provide more storage space.

Higher level decoding functionality means customers can view more channels at the same time, and can record feeds from higher resolution cameras.

IP CAMERAS





Hikvision has a wide range of IP cameras that bring intelligence, efficiency and varied specifications to a wide range of vertical applications.

Cutting-edge features, like excellent night performance and Hikvision's unique H.265+ compression codec provide outstanding image quality, even in challenging lighting environments. Camera form factors vary from box cameras, indoor and outdoor domes and bullets.

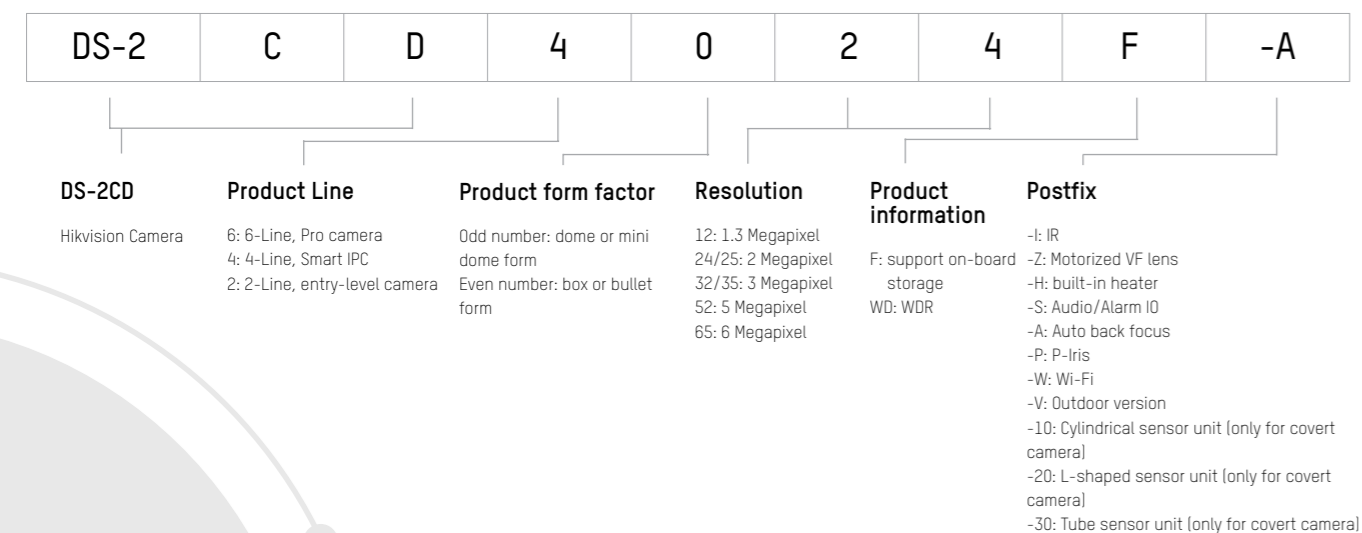
The range also includes cameras with innovative technologies – like ColorVu for colourful images 24/7; and smart AcuSense technology to dramatically reduce false alarms.

NAME CODING RULE



	FIXED MINI BULLET CAMERA	FIXED BULLET CAMERA	FIXED MINI BULLET CAMERA	FIXED BULLET CAMERA	FIXED BULLET CAMERA
Short Description	 2 MP IR Fixed Bullet Network Camera	 2MP Ultra-light Mini Bullet Network Camera	 4 MP IR Fixed Bullet Network Camera	 4 MP IR Fixed Bullet Network Camera	 6 MP IR Fixed Bullet Network Camera
Model	DS-2CD202360-I	DS-2CD2025FWD-I	DS-2CD204360-I	DS-2CD2045FWD-I	DS-2CD2065FWD-I
Image Sensor	1/2.8" Progressive Scan CMOS	1/2.8" Progressive Scan CMOS	1/3" Progressive Scan CMOS	1/2.5" Progressive Scan CMOS	1/2.4" Progressive Scan CMOS
Min. Illumination(Color)	Color: 0.01 Lux @ (F1.2, AGC ON), 0.028 Lux @ (F2.0, AGC ON), 0 Lux with IR	Color: 0.005 lux @ (F1.2, AGC ON), 0 lux with IR	Color: 0.01 Lux @ (F1.2, AGC ON), 0.018 Lux @ (F1.6, AGC ON), 0 Lux with IR	Color: 0.009 lux @ (F1.2, AGC ON), 0.016 lux @ (F1.6, AGC ON), 0 lux with IR	Color: 0.008 Lux @ (F1.2, AGC ON), 0.014 Lux @ (F1.6, AGC ON)
Lens option	2.8mm	2.8mm	2.8mm	2.8mm	2.8/4/6 mm
Horizontal Angle of View	2.8 mm: Horizontal FOV: 103°, vertical FOV: 59°, diagonal FOV: 118°	108°	Horizontal FOV: 98°, vertical FOV: 55°, diagonal FOV: 114°	Horizontal FOV: 109°	2.8 mm, Horizontal FOV: 99°, vertical FOV: 61°, diagonal FOV: 128° 4 mm, Horizontal FOV: 80°, vertical FOV: 51°, diagonal FOV: 101° 6 mm, Horizontal FOV: 60°, vertical FOV: 38°
Video Compression	Main stream: H.265/H.264, Sub-stream: H.265/H.264/MJPEG, Third stream: H.265/H.264	Main stream: H.265/H.264 Sub stream: H.265/H.264/MJPEG Third stream: H.265/H.264	Main stream: H.265/H.264, Sub-stream: H.265/H.264/MJPEG, Third stream: H.265/H.264	Main stream: H.265/H.264 Sub stream: H.265/H.264/MJPEG Third stream: H.265/H.264	Main stream: H.265/H.264 Sub stream: H.265/H.264/MJPEG Third stream: H.265/H.264
Max. Image Resolution	1920 × 1080	1920 × 1080	2560 × 1440	2560 × 1440	3072 × 2048
WDR	120dB	120dB	120dB	120dB	120dB
Operations Conditions	-30 °C to +60 °C (-22 °F to +140 °F), Humidity 95% or less (non-condensing)	-30 °C to +60 °C (-22 °F to +140 °F), Humidity 95% or less (non-condensing)	-30 °C to +60 °C (-22 °F to +140 °F), Humidity 95% or less (non-condensing)	-30 °C to +60 °C (-22 °F to +140 °F), Humidity 95% or less (non-condensing)	-30 °C to +60 °C (-22 °F to +140 °F), Humidity 95% or less (non-condensing)
Power Supply	12 VDC ± 25%, Φ 5.5 mm coaxial power plug, PoE (802.3af, class 3)	12 VDC ± 25%/PoE(802.3af, class 3)	12 VDC ± 25%, Φ 5.5 mm coaxial power plug, PoE (802.3af, class 3)	12 VDC ± 25%/PoE(802.3af, class 3)	12 VDC ± 25%, 5.5 mm coaxial power plug PoE (802.3af, class 3)
Consumption	12 VDC, 0.5A, max. 6W; PoE (802.3af, 37V to 57V), 0.2A to 0.1A, max. 7.5W	-	12 VDC, 0.5A, max. 6W; PoE (802.3af, 37V to 57V), 0.2A to 0.1A, max. 7.5W	12 VDC, 0.5 A, max. 5.5 W PoE (802.3af, 36V to 57V), 0.2 A to 0.1 A, max. 7 W	12 VDC, 0.4 A, max. 6W PoE: (802.3af, 36V to 57V), 0.2 A to 0.1 A, max. 7.5W
IR Range	Up to 30 m	30m	Up to 30 m	30m	Up to 30 m
Weatherproof	IP67	IP67	IP67	IP67	IP67
Protection level	-	-	-	-	IK10
Audio Input/Output	-	-	-	-	-
Alarm Input/Output	-	-	-	-	-

FIXED MINI BULLET CAMERA



FIXED BULLET CAMERA



FIXED DOME CAMERA



Short Description	8 MP IR Fixed Bullet Network Camera	8MP Mini Bullet Network Camera	2 MP IR Fixed Dome Network Camera	2 MP Ultra-Low Light Network Dome Camera	2 MP IR Fixed Dome Network Camera
Model	DS-2CD208360-I	DS-2CD2085FWD-I(B)	DS-2CD212360-I	DS-2CD2125FWD-I(S)	DS-2CD212560-IMS
Image Sensor	1/2.5" Progressive Scan CMOS	1/2.5" Progressive Scan CMOS	1/2.8" Progressive Scan CMOS	1/2.8" Progressive Scan CMOS	1/2.8" Progressive Scan CMOS
Min. Illumination(Color)	Color: 0.01 Lux @ (F1.2, AGC ON), 0.018 Lux @ (F1.6, AGC ON), 0 Lux with IR	0.008 Lux @ (F1.2, AGC ON), 0.014 Lux @ (F1.6, AGC ON)	Color: 0.01 Lux @ (F1.2, AGC ON), 0.028 Lux @ (F2.0, AGC ON), 0 Lux with IR	Color: 0.005 lux @(F1.2, AGC ON), 0 lux with IR	Color: 0.009 Lux @ (F1.6, AGC ON), 0 Lux with IR
Lens option	2.8mm	2.8 mm	2.8mm	2.8mm	2.8/4/6 mm
Horizontal Angle of View	Horizontal FOV: 102°	102°	2.8 mm: Horizontal FOV: 114°, vertical FOV: 62°, diagonal FOV: 135°	108°	2.8 mm, horizontal FOV: 108°, vertical FOV: 58°, diagonal FOV: 128° 4 mm, horizontal FOV: 86°, vertical FOV: 46°, diagonal FOV: 103° 6 mm, horizontal FOV: 52°, vertical FOV: 29°, diagonal FOV: 60°
Video Compression	Main stream: H.265/H.264,Sub-stream: H.265/H.264/MJPEG,Third stream: H.265/H.264	Main stream: H.265/H.264Sub stream: H.265/H.264/MJPEGThird stream: H.265/H.264	Main stream: H.265/H.264,Sub-stream: H.265/H.264/MJPEG,Third stream: H.265/H.264	Main stream: H.265/H.264Sub stream: H.265/H.264	Main stream: H.265/H.264 Sub-stream: H.265/H.264/MJPEG
Max. Image Resolution	3840 × 2160	3840 × 2160	1920 × 1080	1920 × 1080	1920 × 1080
WDR	120dB	120dB	120dB	120dB	120dB
Operations Conditions	-30 °C to +60 °C (-22 °F to +140 °F), Humidity 95% or less (non-condensing)	-30 °C to +60 °C (-22 °F to +140 °F), Humidity 95% or less (non-condensing)	-30 °C to +60 °C (-22 °F to +140 °F), Humidity 95% or less (non-condensing)	-30 °C to +60 °C (-22 °F to +140 °F), Humidity 95% or less (non-condensing)	-10 °C to 40 °C (14 °F to 104 °F), humidity 95% or less (non-condensing)
Power Supply	12 VDC ± 25%, Φ 5.5 mm coaxial power plug,PoE (802.3af, class 3)	12 VDC ± 25%/PoE(802.3af, class 3)	12 VDC ± 25%, Φ 5.5 mm coaxial power plug,PoE (802.3af, class 3)	12 VDC ± 25%/PoE(802.3af, class 3)	Socket style interface: 12 VDC ± 25%, Φ 5.5 mm coaxial power plug; reverse polarity protection; PoE (802.3af, class 3) Pigtail style interface: 12 VDC ± 25%, two-core terminal block; reverse polarity protection; PoE (802.3af, class 3)
Consumption	12 VDC, 0.4 A, max. 6WPoE: (802.3af, 36V to 57V), 0.2 A to 0.1 A, max. 7.5W	7W/7.5W	12 VDC, 0.5A, max. 6W,PoE (802.3af, 37V to 57V), 0.2A to 0.1A, max. 7.5W	-	12 VDC, 0.6 A, max. 7 W; PoE (802.3af, 36 V to 57 V), 0.3 A to 0.2 A, max. 8. 5W
IR Range	Up to 30 m	30m	Up to 30 m	30m	30m
Weatherproof	IP67	IP67	IP67	IP67	IP42
Protection level	-	-	IK10	IK10	IK10
Audio Input/Output	-	-	-	-	1 input (line in/mic in, terminal block), 1 output (two-core terminal block), mono sound
Alarm Input/Output	-	-	-	-	1 input, 1 output (max. 12VDC, 30 mA)



Short Description	2 MP IR Fixed Dome Network Camera	4 MP IR Fixed Dome Network Camera	4 MP IR Fixed Dome Network Camera	4 MP IR Fixed Dome Network Camera	6 MP IR Fixed Dome Network Camera
Model	DS-2CD212661-I(S)	DS-2CD214360-I	DS-2CD214360-I(S)	DS-2CD2145FWD-IS	DS-2CD2165FWD-IS
Image Sensor	1/2.8" Progressive Scan CMOS	1/3" Progressive Scan CMOS	1/3" Progressive Scan CMOS	1/2.5" Progressive Scan CMOS	1/2.4" Progressive Scan CMOS
Min. Illumination(Color)	Color: 0.005 Lux @ (F1.2, AGC ON), 0.009 Lux @ (F1.6, AGC ON)	Color: 0.01 Lux @ (F1.2, AGC ON), 0.018 Lux @ (F1.6, AGC ON), 0 Lux with IR	Color: 0.01 Lux @ (F1.2, AGC ON), 0.018 Lux @ (F1.6, AGC ON), 0 Lux with IR	Color: 0.009 lux @(F1.2, AGC ON), 0.016 lux @(F1.6, AGC ON), 0 lux with IR	Color: 0.008 Lux @ (F1.2, AGC ON), 0.014 Lux @ (F1.6, AGC ON)
Lens option	2.8 mm	2.8mm	4 mm	2.8mm	2.8/4/6 mm
Horizontal Angle of View	2.8 mm, Horizontal FOV: 108°, vertical FOV: 58°, diagonal FOV: 128°	2.8 mm: Horizontal FOV: 98°, vertical FOV: 55°, diagonal FOV: 114°	4 mm, Horizontal FOV: 83°, vertical FOV: 45°, diagonal FOV: 99°	Horizontal FOV:109°	2.8 mm, Horizontal FOV: 99°, vertical FOV: 61°, diagonal FOV: 128° 4 mm, Horizontal FOV: 80°, vertical FOV: 51°, diagonal FOV: 101° 6 mm, Horizontal FOV: 60°, vertical FOV: 38°
Video Compression	Main stream: H.265/H.264Sub stream: H.265/H.264/MJPEG	Main stream: H.265/H.264,Sub-stream: H.265/H.264/MJPEG,Third stream: H.265/H.264	Main stream: H.265/H.264 Sub-stream: H.265/H.264/MJPEG Third stream: H.265/H.264	Main stream: H.265/H.264Sub stream: H.265/H.264/MJPEGThird stream: H.265/H.264	Main stream: H.265/H.264 Sub stream: H.265/H.264/MJPEG Third stream: H.265/H.264
Max. Image Resolution	1920 × 1080	2560 × 1440	2688 × 1520	2560 × 1440	3072 × 2048
WDR	120dB	120dB	120dB	120dB	120dB
Operations Conditions	-30 °C to +50 °C (-22 °F to +122 °F), Humidity 95% or less (non-condensing)	-30 °C to +60 °C (-22 °F to +140 °F), Humidity 95% or less (non-condensing)	-30 °C to +60 °C (-22 °F to +140 °F), Humidity 95% or less (non-condensing)	-30 °C to +60 °C (-22 °F to +140 °F), Humidity 95% or less (non-condensing)	-30 °C to +60 °C (-22 °F to +140 °F), Humidity 95% or less (non-condensing)
Power Supply	12 VDC ± 25%, 5.5 mm coaxial power plugPoE (802.3af, class 3)	12 VDC ± 25%, Φ 5.5 mm coaxial power plug,PoE (802.3af, class 3)	12 VDC ± 25%, Φ 5.5 mm coaxial power plug PoE (802.3af, class 3)	12 VDC ± 25%/PoE(802.3af, class 3)	12 VDC ± 25%, 5.5 mm coaxial power plug PoE (802.3af, class 3)
Consumption	12 VDC, 0.6 A, max: 7 WPoE: (802.3af, 36 V to 57 V), 0.2 A to 0.1 A, max: 8.5 W	12 VDC, 0.5A, max. 6W,PoE (802.3af, 37V to 57V), 0.2A to 0.1A, max. 7.5W	12 VDC, 0.5A, max. 6W PoE (802.3af, 37V to 57V), 0.2A to 0.1A, max. 7.5W	12 VDC, 0.5 A, max. 5.5 WPoE (802.3af, 36V to 57V), 0.2 A to 0.1 A, max. 7 W	12 VDC, 0.4 A, max. 6W PoE: (802.3af, 36V to 57V), 0.2 A to 0.1 A, max. 7.5W
IR Range	Up to 30 m	Up to 30 m	Up to 30 m	30m	Up to 30 m
Weatherproof	IP67	IP67	IP67	IP67	IP67
Protection level	IK10	IK10	IK10	IK10	IK10
Audio Input/Output	1/1	-	1/1	-	1 audio input (line in), 1 audio output interface, terminal block
Alarm Input/Output	1/1	-	1/1	-	1 alarm input, 1 alarm output (max. 12VDC, 30 mA), terminal block

FIXED TURRET CAMERA



Short Description	8 MP IR Fixed Dome Network Camera	2 MP IR Fixed Turret Network Camera	2MP Ultra-Low Light Network Turret Camera	4 MP IR Fixed Turret Network Camera	4 MP IR Fixed Turret Network Camera
Model	DS-2CD218360-I	DS-2CD232360-I	DS-2CD2325FWD-I	DS-2CD234360-I	DS-2CD2345FWD-I
Image Sensor	1/2.5" Progressive Scan CMOS	1/2.8" Progressive Scan CMOS	1/2.5" Progressive Scan CMOS	1/3" Progressive Scan CMOS	1/2.5" Progressive Scan CMOS
Min. Illumination(Color)	Color: 0.01 Lux @ (F1.2, AGC ON), 0.018 Lux @ (F1.6, AGC ON), 0 Lux with IR	Color: 0.01 Lux @ (F1.2, AGC ON), 0.028 Lux @ (F2.0, AGC ON), 0 Lux with IR	0.005 lux @ (F1.2, AGC ON), 0 lux with IR	Color: 0.01 Lux @ (F1.2, AGC ON), 0.018 Lux @ (F1.6, AGC ON), 0 Lux with IR	Color: 0.009 lux @ (F1.2, AGC ON), 0.016 lux @ (F1.6, AGC ON), 0 lux with IR
Lens option	2.8mm	2.8mm	2.8 mm	2.8mm	2.8 mm
Horizontal Angle of View	Horizontal FOV: 102°	Horizontal FOV: 114°, vertical FOV: 62°, diagonal FOV: 135°	108°	2.8 mm: Horizontal FOV: 98°, vertical FOV: 55°, diagonal FOV: 114°	Horizontal FOV: 109°
Video Compression	Main stream: H.265/H.264, Sub-stream: H.265/H.264/MJPEG, Third stream: H.265/H.264	Main stream: H.265/H.264, Sub-stream: H.265/H.264/MJPEG, Third stream: H.265/H.264	Main stream: H.265/H.264, Sub stream: H.265/H.264/MJPEG, Third stream: H.265/H.264	Main stream: H.265/H.264, Sub-stream: H.265/H.264/MJPEG, Third stream: H.265/H.264	Main stream: H.265/H.264, Sub stream: H.265/H.264/MJPEG, Third stream: H.265/H.264
Max. Image Resolution	3840 × 2160	1920 × 1080	1920 × 1080	2560 × 1440	2560 × 1440
WDR	120dB	3D DNR	120dB	120dB	120dB
Operations Conditions	-30 °C to +60 °C (-22 °F to +140 °F), Humidity 95% or less (non-condensing)	-30 °C to +60 °C (-22 °F to +140 °F), Humidity 95% or less (non-condensing)	-30°C +60 °C (-22 °F to +140 °F), Humidity 95% or less (non-condensing)	-30 °C to +60 °C (-22 °F to +140 °F), Humidity 95% or less (non-condensing)	-30 °C to +60 °C (-22 °F to +140 °F), Humidity 95% or less (non-condensing)
Power Supply	12 VDC ± 25%, Φ 5.5 mm coaxial power plug, PoE (802.3af, class 3)	12 VDC ± 25%, Φ 5.5 mm coaxial power plug, PoE (802.3af, class 3)	12 VDC ± 25%/PoE(802.3af, 42.5 – 57V, class 3)	12 VDC ± 25%, Φ 5.5 mm coaxial power plug, PoE (802.3af, class 3)	12 VDC ± 25%, PoE(802.3af, class 3)
Consumption	12 VDC, 0.5A, max. 6W, PoE (802.3af, 37V to 57V), 0.2A to 0.1A, max. 7.5W	12 VDC, 0.5A, max. 6W, PoE (802.3af, 37V to 57V), 0.2A to 0.1A, max. 7.5W	-	12 VDC, 0.5A, max. 6W, PoE (802.3af, 37V to 57V), 0.2A to 0.1A, max. 7.5W	12 VDC, 0.5 A, max. 6 W PoE (802.3af, 36V to 57V), 0.3 A to 0.2 A, max. 7.5 W
IR Range	Up to 30 m	Up to 30 m	30m	Up to 30 m	30m
Weatherproof	IP67	IP67	IP67	IP67	IP67
Protection level	IK10	-	-	-	-
Audio Input/Output	1/1(-S)	-	-	-	-
Alarm Input/Output	1/1(-S)	-	-	-	-

CUBE CAMERA



Short Description	6MP Network Turret Camera	8 MP IR Fixed Turret Network Camera	8MP Network Turret Camera	8 MP IR Fixed Turret Network Camera	2 MP EXIR Fixed Cube Network Camera
Model	DS-2CD2365FWD-I	DS-2CD238360-I	DS-2CD2385FWD-I	DS-2CD2386G2-I	DS-2CD2425FWD-I(W)(S)
Image Sensor	1/2.4" Progressive Scan CMOS	1/2.5" Progressive Scan CMOS	1/2.5" Progressive Scan CMOS	1/2" Progressive Scan CMOS	1/2.8" Progressive Scan CMOS
Min. Illumination(Color)	Color: 0.008 Lux @ (F1.2, AGC ON), 0.014 Lux @ (F1.6, AGC ON)	Color: 0.01 Lux @ (F1.2, AGC ON), 0.018 Lux @ (F1.6, AGC ON), 0 Lux with IR	0.01 lux @ (F1.2, AGC ON), 0 lux with IR	0.014 Lux @ (F1.6, AGC ON), 0 Lux with IR	Color: 0.005 Lux @ (F1.2, AGC ON), 0 Lux with IR; Color: 0.009 lux @ (F1.6, AGC ON), 0 lux with IR
Lens option	2.8 mm	2.8mm	2.8 mm	2.8mm	2.8 mm
Horizontal Angle of View	99°	Horizontal FOV: 102°	102°	horizontal FOV: 110.7° , vertical FOV: 59.1° , diagonal FOV: 131°	108°
Video Compression	Main stream: H.265/H.264, Sub stream: H.265/H.264/MJPEG, Third stream: H.265/H.264	Main stream: H.265/H.264, Sub-stream: H.265/H.264/MJPEG, Third stream: H.265/H.264	Main stream: H.265/H.264, Sub stream: H.265/H.264/MJPEG, Third stream: H.265/H.264	Main stream: H.265+/H.264+/H.265/H.264, Sub-stream: H.265/H.264/MJPEG, Third stream: H.265/H.264	Main stream: H.265/H.264, Sub stream: H.265/H.264/MJPEG
Max. Image Resolution	3072 × 2048	3840 × 2160	3840 × 2160	3840 × 2160	1920 × 1080
WDR	120dB	120dB	120dB	120dB	120dB
Operations Conditions	-30°C +60 °C (-22 °F to +140 °F), Humidity 95% or less (non-condensing)	-30 °C to +60 °C (-22 °F to +140 °F), Humidity 95% or less (non-condensing)	-30°C +60 °C (-22 °F to +140 °F), Humidity 95% or less (non-condensing)	-30 °C to 60 °C (-22 °F to 140 °F), humidity 95% or less (non-condensing)	-10 °C to +40 °C (14 °F to +104 °F), Humidity: 95% or less (non-condensing)
Power Supply	12 VDC ± 25%, 5.5 mm coaxial power plug PoE (802.3af, class 3)	12 VDC ± 25%, Φ 5.5 mm coaxial power plug, PoE (802.3af, class 3)	12 VDC ± 25%/PoE(802.3af, 42.5 – 57V, class 3)	12 VDC ± 25%, Φ 5.5 mm coaxial power plug; reverse polarity protection; PoE (802.3af, class 3)	12 VDC ± 20%, PoE (802.3af, class 3)
Consumption	12 VDC, 0.5 A, max: 6 W PoE: (802.3af, 36 VDC to 57 VDC), 0.3 A to 0.2 A, max: 7.5 W	12 VDC, 0.5A, max. 6W, PoE (802.3af, 37V to 57V), 0.2A to 0.1A, max. 7.5W	-	12 VDC, 0.48 A, max. 5.8 W; PoE (802.3af, 36 V to 57 V), 0.19 A to 0.12 A, max. 6.8 W	12 VDC, 0.38A, max. 7W PoE (802.3af, 36V to 57V), 0.2 A to 0.1 A, max. 7W
IR Range	30m	Up to 30 m	30m	30m	Up to 10 m
Weatherproof	IP67	IP67	IP67	IP67	-
Protection level	-	-	-	-	-
Audio Input/Output	-	-	-	-	1/1
Alarm Input/Output	-	-	-	-	-

FIXED MINI DOME CAMERA



Short Description	4 MP IR Fixed Cube Network Camera	2 MP EXIR Fixed Mini Dome Network Camera	2 MP EXIR Fixed Mini Dome Network Camera	4 MP EXIR Fixed Mini Dome Network Camera	4 MP IR Fixed Mini Dome Network Camera
Model	DS-2CD244360-I(W)	DS-2CD252360-IS	DS-2CD2525FWD-I(W)(S)	DS-2CD254360-IS	DS-2CD2545FWD-IS
Image Sensor	1/3" Progressive Scan CMOS	1/2.7" Progressive Scan CMOS	1/2.8" Progressive Scan CMOS	1/3" Progressive Scan CMOS	1/2.5" Progressive Scan CMOS
Min. Illumination(Color)	Color: 0.01 Lux @ (F1.2, AGC ON), 0.018 lux @ (F1.6, AGC ON), 0 lux with IR	Color: 0.01 Lux @ (F1.2, AGC ON), 0.018 lux @ (F1.6, AGC ON), 0 lux with IR	Color: 0.005 Lux @ (F1.2, AGC ON), 0 Lux with IR; Color: 0.009 lux @ (F1.6, AGC ON), 0 lux with IR	Color: 0.01 Lux @ (F1.2, AGC ON), 0.018 lux @ (F1.6, AGC ON), 0 lux with IR	Color: 0.008 Lux @ (F1.2, AGC ON), 0.014 lux @ (F1.6, AGC ON), 0 lux with IR
Lens option	2.8 mm	2.8mm	2.8mm	2.8mm	2.8mm
Horizontal Angle of View	2.8 mm, Horizontal FOV: 98°, vertical FOV: 55°, diagonal FOV: 114°	Horizontal FOV: 114°	108°	Horizontal FOV: 98°	Horizontal field of view: 109°, Vertical field of view: 60°, Diagonal field of view: 131°
Video Compression	Main stream: H.265/H.264 Sub-stream: H.265/H.264/MJPEG Third stream: H.265/H.264	Main stream: H.265/H.264Sub stream: H.265/H.264/MJPEGThird stream: H.265/H.264	Main stream: H.265/H.264Sub stream: H.265/H.264/MJPEG	Main stream: H.265/H.264Sub stream: H.265/H.264/MJPEGThird stream: H.265/H.264	Main stream: H.265/H.264 Sub-stream: H.265/H.264/MJPEG Third stream: H.265/H.264
Max. Image Resolution	2688 × 1520	1920 × 1080	1920 × 1080	2688 × 1520	2688 × 1520
WDR	120dB	120dB	120dB	120dB	120dB
Operations Conditions	-10 °C to +40 °C (14 °F to +104 °F), Humidity 95% or less (non-condensing)	-30 °C to +60 °C (-22 °F to +140 °F), Humidity 95% or less (non-condensing)	-30 °C to 60 °C (-22 °F to 140 °F), Humidity: 95% or less (non-condensing)	-30 °C to +60 °C (-22 °F to +140 °F), Humidity 95% or less (non-condensing)	Operating Conditions -30 °C to +60 °C (-22 °F to +140 °F), Humidity 95% or less (non-condensing)
Power Supply	12 VDC ± 25%, PoE (802.3af, class 3)	12 VDC ± 25%, PoE (802.3af, class 3)	12 VDC ± 25%, PoE (802.3af, class 3)	12 VDC ± 25%, PoE (802.3af, class 3)	12 VDC ± 25%, PoE (802.3af)
Consumption	12 VDC, 0.5 A, max. 6 W, Φ 5.5 mm coaxial plug power PoE (802.3af, 36V to 57V), 0.2 A to 0.1 A, max. 7W	12 VDC, 0.7A, max. 8.5W, Φ 5.5mm coaxial plug powerPoE (802.3af, 36V to 57V), 0.3 A to 0.1 A, max. 10W	12 VDC, 0.625A, max. 7.5WPoE (802.3af, 36V to 57V), 0.26 A to 0.17 A, max. 9.5W	12 VDC, 0.7A, max. 8.5W, Φ 5.5mm coaxial plug powerPoE (802.3af, 36V to 57V), 0.3 A to 0.1 A, max. 10W	12 VDC, 0.7 A, max. 8.5 W, Φ 5.5mm coaxial plug power PoE (802.3af, 36 V to 57 V), 0.3 A to 0.1 A, max. 10 W
IR Range	10 m	Up to 10 m	Up to 10 m	Up to 10 m	10m
Weatherproof	-	IP66	IP66	IP66	IP66
Protection level	-	IK08	IK08	IK08	IK08
Audio Input/Output	1/1	2/1	2/1(-S)	-	2/1
Alarm Input/Output	-	1/1	1/1(-S)	-	1/1

VARI-FOCAL BULLET CAMERA



Short Description	2 MP IR Varifocal Bullet Network Camera	2MP WDR Vari-focal Network Bullet Camera	4 MP IR Varifocal Bullet Network Camera	4 MP IR VF Bullet Network Camera	4 MP IR VF Bullet Network Camera
Model	DS-2CD262361-IZ(S)	DS-2CD2625FWD-IZS	DS-2CD264361-IZ(S)	DS-2CD2645FWD-IZS	DS-2CD2645FWD-IZS(BLACK)
Image Sensor	1/2.8" Progressive Scan CMOS	1/2.8" Progressive Scan CMOS	1/3" Progressive Scan CMOS	1/2.5" Progressive Scan CMOS	1/2.5" Progressive Scan CMOS
Min. Illumination(Color)	Color: 0.01 Lux @ (F1.2, AGC ON), 0.018 Lux @ (F1.6, AGC ON), 0 Lux with IR	Color: 0.005 Lux @ (F1.2, AGC ON), 0 Lux with IRCColor: 0.0068 Lux @ (F1.4, AGC ON), 0 Lux with IR	Color: 0.01 Lux @ (F1.2, AGC ON), 0.018 Lux @ (F1.6, AGC ON), 0 Lux with IR	Color: 0.009 lux @ (F1.2, AGC ON), 0.016 lux @ (F1.6, AGC ON), 0 lux with IR	Color: 0.009 lux @ (F1.2, AGC ON), 0.016 lux @ (F1.6, AGC ON), 0 lux with IR
Lens option	2.8-12 mm	2.8-12mm	2.8-12 mm	2.8-12mm	2.8-12mm
Horizontal Angle of View	Horizontal FOV: 110° to 31°vertical FOV: 58° to 18°diagonal FOV: 136° to 36°	105°-35°	horizontal FOV: 104° to 29° vertical FOV: 55° to 17° diagonal FOV: 125° to 34°	Horizontal FOV: 114° to 32°	Horizontal FOV: 114° to 32°
Video Compression	Main stream: H.265/H.264Sub-stream: H.265/H.264/MJPEGThird stream: H.265/H.264	Main stream: H.265+/H.265/H.264+/H.264Sub stream: H.265+/H.265/H.264+/H.264/MJPEGThird stream: H.265+/H.265/H.264+/H.264	Main stream: H.265/H.264 Sub-stream: H.265/H.264/MJPEG Third stream: H.265/H.264	Main stream: H.265+/H.265/H.264+/H.264Sub stream: H.265+/H.265/H.264+/H.264/MJPEGThird stream: H.265+/H.265/H.264+/H.264	Main stream: H.265+/H.265/H.264+/H.264Sub stream: H.265+/H.265/H.264+/H.264/MJPEGThird stream: H.265+/H.265/H.264+/H.264
Max. Image Resolution	1920 × 1080	1920 × 1080	2688 × 1520	2560 × 1440	2560 × 1440
WDR	120dB	120dB	120dB	120dB	120dB
Operations Conditions	-30 °C to +60 °C (-22 °F to +140 °F), Humidity 95% or less (non-condensing)	-30°C +60 °C (-22 °F to +140 °F), Humidity 95% or less (non-condensing)	-30 °C to +60 °C (-22 °F to +140 °F), Humidity 95% or less (non-condensing)	-30 °C to +60 °C (-22 °F to +140 °F), Humidity 95% or less (non-condensing)	-30 °C to +60 °C (-22 °F to +140 °F), Humidity 95% or less (non-condensing)
Power Supply	12 VDC ± 25%, PoE (802.3af, class 3)	12 VDC ± 25%/PoE(802.3af, 42.5 – 57V, class 3)	12 VDC ± 25%, PoE (802.3af, class 3)	12 VDC ± 25%, terminal block for DC inputPoE(802.3af, class 4)	12 VDC ± 25%, terminal block for DC inputPoE(802.3af, class 4)
Consumption	12 VDC, 1.2A, max. 14.5WPoE (802.3af, 42.5V to 57V), 0.43A to 0.3A, max. 18W	-	12 VDC, 1.2A, max. 14.5W PoE (802.3af, 42.5V to 57V), 0.43A to 0.3A, max. 18W	12 VDC, 1.2 A, max. 14.4 WPoE (802.3af, 42.5V to 57V), 0.5 A to 0.3 A, max. 18 W	12 VDC, 1.2 A, max. 14.4 WPoE (802.3af, 42.5V to 57V), 0.5 A to 0.3 A, max. 18 W
IR Range	50m	30m	50m	50m	50m
Weatherproof	IP67	IP67	IP67	IP67	IP67
Protection level	-	IK10	-	IK10	IK10
Audio Input/Output	1 input (line in/mic.in), 1 output (line out), mono sound, terminal block	1/1	1 input (line in/mic.in), 1 output (line out), mono sound, terminal block	1/1	1/1
Alarm Input/Output	1 input, 1 output (max. 12 VDC, 30 mA), terminal block	1/1	1 input, 1 output (max. 12 VDC, 30 mA), terminal block	1/1	1/1



VARI-FOCAL DOME CAMERA



Short Description	6 MP IR Varifocal Bullet Network Camera	8MP WDR Vari-focal Network Bullet Camera	8 MP IR Varifocal Bullet Network Camera	2 MP IR Varifocal Dome Network Camera	2MP WDR Vari-focal Network Dome Camera
Model	DS-2CD2665FWD-IZS	DS-2CD2685FWD-IZS(B)	DS-2CD2686G2-IZS	DS-2CD272361-IZ(S)	DS-2CD2725FWD-IZS
Image Sensor	1/2.4" Progressive Scan CMOS	1/2.5" Progressive Scan CMOS	1/1.8" Progressive Scan CMOS	1/2.8" Progressive Scan CMOS	1/2.8" Progressive Scan CMOS
Min. Illumination(Color)	Color: 0.008 Lux @ (F1.2, AGC ON), 0.014 Lux @ (F1.6, AGC ON)	Color: 0.008 Lux @ (F1.2, AGC ON), 0.011 Lux @ (F1.4, AGC ON)	Color: 0.011 Lux @ (F1.4, AGC ON)	Color: 0.01 Lux @ (F1.2, AGC ON), 0.018 Lux @ (F1.6, AGC ON), 0 Lux with IR	Color: 0.005 Lux @ (F1.2, AGC ON), 0 Lux with IR Color: 0.0068 Lux @ (F1.4, AGC ON), 0 Lux with IR
Lens option	2.8-12 mm	2.8-12mm	2.8 to 12 mm	2.8-12 mm	2.8-12mm
Horizontal Angle of View	Horizontal field of view: 114° to 34° Vertical field of view: 71° to 23° Diagonal field of view: 154° to 41°	97°-33°	Horizontal FOV: 108.1° to 45.5°, vertical FOV: 58.4° to 25.7°, diagonal FOV: 127.3° to 52.1°	Horizontal FOV: 110° to 31° vertical FOV: 58° to 18° diagonal FOV: 136° to 36°	105°-35°
Video Compression	Main stream: H.265/H.264 Sub stream: H.265+/H.265/MJPEG Third stream: H.265/H.264	Main stream: H.265+/H.265/H.264+/H.264 Sub stream: H.265+/H.265/H.264+/H.264/MJPEG Third stream: H.265+/H.265/H.264+/H.264	Main stream: H.265+/H.264+/H.265/H.264 Sub stream: H.265/H.264/MJPEG Third stream: H.265/H.264	Main stream: H.265/H.264 Sub stream: H.265+/H.265/MJPEG Third stream: H.265/H.264	Main stream: H.265+/H.265/H.264+/H.264 Sub stream: H.265+/H.265/H.264+/H.264/MJPEG Third stream: H.265+/H.265/H.264+/H.264
Max. Image Resolution	3072 × 2048	3840 × 2160	3840 × 2160	1920 × 1080	1920 × 1080
WDR	120dB	120dB	120dB	120dB	120dB
Operations Conditions	-30 °C to +60 °C (-22 °F to +140 °F), Humidity 95% or less (non-condensing)	-30°C +60 °C (-22 °F to +140 °F), Humidity 95% or less (non-condensing)	-30 °C to 60 °C (-22 °F to 140 °F), humidity 95% or less (non-condensing)	-30 °C to +60 °C (-22 °F to +140 °F), Humidity 95% or less (non-condensing)	-30°C +60 °C (-22 °F to +140 °F), Humidity 95% or less (non-condensing)
Power Supply	12 VDC ± 25% PoE (802.3af, class 4)	12 VDC ± 25%, PoE (802.3at) Terminal block for DC input	12 VDC ± 25%, two-core terminal block; reverse polarity protection; PoE (802.3af, class 4)	12 VDC ± 25%, PoE (802.3af, class 3)	12 VDC ± 25%, PoE (802.3at) Terminal block for DC input
Consumption	12 VDC, 1.2A, max. 14.5W PoE: (802.3af, 42.5V to 57V), 0.5A to 0.3A, max. 18W	-	12 VDC, 1.12 A, max. 13.5 W; PoE (802.3af, 42.5 V to 57 V), 0.5 A to 0.3 A, max. 15 W	12 VDC, 0.8A, max. 10WPoE (802.3af, 36V to 57V), 0.35A to 0.2A, max. 12W	-
IR Range	Up to 50 m	50m	50m	50m	30m
Weatherproof	IP67	IP67	IP66	IP67	IP67
Protection level	IK10	IK10	IK10	IK10	IK10
Audio Input/Output	1 input (line in, 3.5 mm), 1 output (3.5 mm), mono sound	1/1	1 audio input (line in), two-core terminal block; 1 audio output (line out), two-core terminal block	1 input (line in/mic.in), 1 output (line out), mono sound, terminal block	1/1
Alarm Input/Output	1 input, 1 output (max. 12 VDC, 30 mA)	1/1		1 input, 1 output (max. 12 VDC, 30 mA), terminal block	1/1

Short Description	4 MP IR Varifocal Dome Network Camera	4 MP IR VF Dome Network Camera	4 MP IR VF Dome Network Camera	6 MP IR Varifocal Dome Network Camera	8MP WDR Vari-focal Network Dome Camera
Model	DS-2CD274361-IZ(S)	DS-2CD2745FWD-IZS(B)	DS-2CD2745FWD-IZS(BLACK)	DS-2CD2765FWD-IZS	DS-2CD2785FWD-IZS(B)
Image Sensor	1/3" Progressive Scan CMOS	1/2.5" Progressive Scan CMOS	1/2.5" Progressive Scan CMOS	1/2.4" Progressive Scan CMOS	1/2.9" Progressive Scan CMOS
Min. Illumination(Color)	Color: 0.01 Lux @ (F1.2, AGC ON), 0.018 Lux @ (F1.6, AGC ON), 0 Lux with IR	Color: 0.009 lux @ (F1.2, AGC ON), 0.016 lux @ (F1.6, AGC ON), 0 lux with IR	Color: 0.009 lux @ (F1.2, AGC ON), 0.016 lux @ (F1.6, AGC ON), 0 lux with IR	Color: 0.008 Lux @ (F1.2, AGC ON), 0.011 Lux @ (F1.4, AGC ON)	Color: 0.008 Lux @ (F1.2, AGC ON), 0.011 Lux @ (F1.4, AGC ON)
Lens option	2.8-12 mm	2.8-12mm	2.8-12mm	2.8-12 mm	2.8-12mm
Horizontal Angle of View	horizontal FOV: 104° to 29° vertical FOV: 55° to 17° diagonal FOV: 125° to 34°	Horizontal FOV: 114° to 32°	Horizontal FOV: 114° to 32°	Horizontal field of view: 114° to 34° Vertical field of view: 71° to 23° Diagonal field of view: 154° to 41°	120°-36°
Video Compression	Main stream: H.265/H.264 Sub-stream: H.265+/H.265/MJPEG Third stream: H.265/H.264	Main stream: H.265+/H.265/H.264+/H.264 Sub stream: H.265+/H.265/H.264+/H.264/MJPEG Third stream: H.265+/H.265/H.264+/H.264	Main stream: H.265+/H.265/H.264+/H.264 Sub stream: H.265+/H.265/H.264+/H.264/MJPEG Third stream: H.265+/H.265/H.264+/H.264	Main stream: H.265/H.264 Sub stream: H.265+/H.265/MJPEG Third stream: H.265/H.264	Main stream: H.265+/H.265/H.264+/H.264 Sub stream: H.265+/H.265/H.264+/H.264/MJPEG Third stream: H.265+/H.265/H.264+/H.264
Max. Image Resolution	2688 × 1520	2560 × 1440	2560 × 1440	3072 × 2048	3840 × 2160
WDR	120dB	120dB	120dB	120dB	120dB
Operations Conditions	-30 °C to +60 °C (-22 °F to +140 °F), Humidity 95% or less (non-condensing)	-30 °C to +60 °C (-22 °F to +140 °F), Humidity 95% or less (non-condensing)	-30 °C to +60 °C (-22 °F to +140 °F), Humidity 95% or less (non-condensing)	-30 °C to +60 °C (-22 °F to +140 °F), Humidity 95% or less (non-condensing)	-30°C +60 °C (-22 °F to +140 °F), Humidity 95% or less (non-condensing)
Power Supply	12 VDC ± 25%, PoE (802.3af, class 3)	12 VDC ± 25%, PoE (802.3at) Terminal block for DC input	12 VDC ± 25%, PoE (802.3at) Terminal block for DC input	12 VDC ± 25% PoE (802.3af, class 3)	12 VDC ± 25%, PoE (802.3at) Terminal block for DC input
Consumption	12 VDC, 0.8A, max. 10W PoE (802.3af, 36V to 57V), 0.35A to 0.2A, max. 12W	12 VDC, 1 A, max. 11 WPoE (802.3af, 36V to 57V), 0.4 A to 0.2 A, max. 12.5 W	12 VDC, 1 A, max. 11 WPoE (802.3af, 36V to 57V), 0.4 A to 0.2 A, max. 12.5 W	12 VDC, 0.9A, max. 10.5W PoE: (802.3af, 36V to 57V), 0.4A to 0.2A, max. 12.5W	-
IR Range	30m	30m	30m	Up to 50 m	30m
Weatherproof	IP67	IP67	IP67	IP67	IP67
Protection level	IK10	IK10	IK10	IK10	IK10
Audio Input/Output	1 input (line in/mic.in), 1 output (line out), mono sound, terminal block	1/1	1/1	1 input (line in, 3.5 mm), 1 output (3.5 mm), mono sound	1/1
Alarm Input/Output	1 input, 1 output (max. 12 VDC, 30 mA), terminal block	1/1	1/1	1 input, 1 output (max. 12 VDC, 30 mA)	1/1



VARI-FOCAL TURRET CAMERA



FIXED BULLET CAMERA



Short Description	8 MP IR Varifocal Dome Network Camera	2 MP WDR Vari-focal Network Turret Camera	4 MP IR VF Turret Network Camera	4 MP IR VF Turret Network Camera	2 MP IR Fixed Bullet Network Camera
Model	DS-2CD278662-IZS	DS-2CD2H25FWD-IZS	DS-2CD2H45FWD-IZS(B)	DS-2CD2H45FWD-IZS(BLACK)	DS-2CD2T2360-1S/18
Image Sensor	1/2" Progressive Scan CMOS	1/2.8" Progressive Scan CMOS	1/2.5" Progressive Scan CMOS	1/2.5" Progressive Scan CMOS	1/2.8" Progressive Scan CMOS
Min. Illumination(Color)	0.011 Lux @ (F1.4, AGC ON), 0 Lux with IR	Color: 0.005 Lux @ (F1.2, AGC ON), 0 Lux with IR Color: 0.0068 Lux @ (F1.4, AGC ON), 0 Lux with IR	Color: 0.009 lux @ (F1.2, AGC ON), 0.016 lux @ (F1.6, AGC ON), 0 lux with IR	Color: 0.009 lux @ (F1.2, AGC ON), 0.016 lux @ (F1.6, AGC ON), 0 lux with IR	Color: 0.01 Lux @ (F1.2, AGC ON), 0.028 Lux @ (F2.0, AGC ON), 0 Lux with IR
Lens option	2.8 to 12 mm	2.8 -12 mm	2.8-12 mm	2.8-12 mm	2.8mm
Horizontal Angle of View	Horizontal FOV: 108.1° to 45.5°, vertical FOV: 58.4° to 25.7°, diagonal FOV: 127.3° to 52.1°	105°-35°	Horizontal FOV: 114° to 32°	Horizontal FOV: 114° to 32°	Horizontal FOV: 114°, vertical FOV: 62°, diagonal FOV: 135°
Video Compression	Main stream: H.265+/H.264+/H.265/H.264 Sub-stream: H.265/H.264/MJPEG Third stream: H.265/H.264	Main stream: H.265+/H.265/H.264+/H.264 Sub stream: H.265+/H.265/H.264+/H.264/MJPEG Third stream: H.265+/H.265/H.264+/H.264	Main stream: H.265+/H.265/H.264+/H.264 Sub stream: H.265+/H.265/H.264+/H.264/MJPEG Third stream: H.265+/H.265/H.264+/H.264	Main stream: H.265+/H.265/H.264+/H.264 Sub stream: H.265+/H.265/H.264+/H.264/MJPEG Third stream: H.265+/H.265/H.264+/H.264	Main stream: H.265/H.264,Sub-stream: H.265/H.264/MJPEG,Third stream: H.265/H.264
Max. Image Resolution	3840 × 2160	1920 × 1080	2560 × 1440	2560 × 1440	1920 × 1080
WDR	120dB	120dB	120dB	120dB	120dB
Operations Conditions	-30 °C to 60 °C [-22 °F to 140 °F], humidity 95% or less (non-condensing)	-30 °C to +60 °C [-22 °F to +140 °F], Humidity 95% or less (non-condensing)	-30 °C to +60 °C [-22 °F to +140 °F], Humidity 95% or less (non-condensing)	-30 °C to +60 °C [-22 °F to +140 °F], Humidity 95% or less (non-condensing)	-30 °C to +60 °C [-22 °F to +140 °F], Humidity 95% or less (non-condensing)
Power Supply	12 VDC ± 25%, Φ 5.5 mm coaxial power plug; reverse polarity protection; PoE (802.3af, class 3)	12 VDC ± 25%, PoE (802.3af)Terminal block for DC input	12 VDC ± 25%, PoE (802.3af)Terminal block for DC input	12 VDC ± 25%, PoE (802.3af)Terminal block for DC input	12 VDC ± 25%, Φ 5.5 mm coaxial power plug,PoE (802.3af, class 3)
Consumption	12 VDC, 0.9 A, max. 10.8 W; PoE (802.3af, 36 V to 57 V), 0.4 A to 0.2 A, max. 12.9 W	Max. 10W	12 VDC, 1 A, max. 11 W PoE (802.3af, 36V to 57V), 0.4 A to 0.3 A, max. 12.5 W	12 VDC, 1 A, max. 11 W PoE (802.3af, 36V to 57V), 0.4 A to 0.3 A, max. 12.5 W	12 VDC, 0.6A, max. 7.5W,PoE (802.3af, 37V to 57V), 0.2A to 0.1A, max. 9.5W
IR Range	30m	Up to 30 m	Up to 30 m	Up to 30 m	Up to 50 m
Weatherproof	IP67	IP67	IP67	IP67	IP67
Protection level	IK10	IK10	IK10	IK10	-
Audio Input/Output		1/1	1/1	1/1	-
Alarm Input/Output		1/1	1/1	1/1	-

Short Description	4 MP IR Fixed Bullet Network Camera	4 MP IR Fixed Bullet Network Camera	6MP EXIR Network Bullet Camera	8 MP IR Fixed Bullet Network Camera	8 MP IR Fixed Bullet Network Camera
Model	DS-2CD2T4360-1S/18	DS-2CD2T45FWD-1S/18	DS-2CD2T65FWD-1S/18	DS-2CD2T85FWD-1S/18(B)	DS-2CD2T8662-2I
Image Sensor	1/3" Progressive Scan CMOS	1/2.5" Progressive Scan CMOS	1/2.5" Progressive Scan CMOS	1/2.5" Progressive Scan CMOS	1/2" Progressive Scan CMOS
Min. Illumination(Color)	Color: 0.01 Lux @ (F1.2, AGC ON), 0.018 Lux @ (F1.6, AGC ON), 0 Lux with IR	Color: 0.008 lux @ (F1.2, AGC ON), 0.014 lux @ (F1.6, AGC ON), 0 lux with IR	Color: 0.008 Lux @ (F1.2, AGC ON), 0.014 Lux @ (F1.6, AGC ON)	Color: 0.008 Lux @ (F1.2, AGC ON), 0.014 Lux @ (F1.6, AGC ON)	0.014 Lux @ (F1.6, AGC ON), 0 Lux with IR
Lens option	2.8/4/6/8 mm	2.8, 4, 6, 8, 12 mm	2.8mm	2.8/4/6 mm	4mm
Horizontal Angle of View	2.8 mm, Horizontal FOV: 103°, vertical FOV: 58°, diagonal FOV: 123° 4 mm, Horizontal FOV: 83°, vertical FOV: 45°, diagonal FOV: 99° 6 mm, Horizontal FOV: 51°, vertical FOV: 29°, diagonal FOV: 58° 8 mm, Horizontal FOV: 39°, vertical FOV: 22°, diagonal FOV: 45°	2.8 mm, Horizontal FOV: 109°, vertical FOV: 60°, diagonal FOV: 131° 4 mm, Horizontal FOV: 88°, vertical FOV: 46°, diagonal FOV: 105° 6 mm, Horizontal FOV: 53°, vertical FOV: 30°, diagonal FOV: 61° 8 mm, Horizontal FOV: 41°, vertical FOV: 23°, diagonal FOV: 48° 12 mm, Horizontal FOV: 25°, vertical FOV: 14°, diagonal FOV: 29°	80°	79°	horizontal FOV: 87.1°, vertical FOV: 47.4°, diagonal FOV: 101.8°
Video Compression	Main stream: H.265/H.264 Sub-stream: H.265/H.264/MJPEG Third stream: H.265/H.264	Main stream: H.265+/H.265/H.264+/H.264 Sub stream: H.265+/H.265/H.264+/H.264/MJPEG Third stream: H.265+/H.265/H.264+/H.264	Main stream: H.265/H.264Sub stream: H.265/H.264/MJPEGThird stream: H.265/H.264	Main stream: H.265/H.264Sub stream: H.265/H.264/MJPEGThird stream: H.265/H.264	Main stream: H.265+/H.264+/H.265/H.264 Sub-stream: H.265/H.264/MJPEG Third stream: H.265/H.264
Max. Image Resolution	2688 × 1520	2688 × 1520	3072 × 2048	3840 × 2160	3840 × 2160
WDR	120dB	120dB	120dB	120dB	120dB
Operations Conditions	-30 °C to +60 °C [-22 °F to +140 °F], Humidity 95% or less (non-condensing)	-30 °C to +60 °C [-22 °F to +140 °F], Humidity 95% or less (non-condensing)	-30°C – 60 °C [-22 °F – 140 °F], Humidity 95% or less (non-condensing), -H: -40 °C – 60 °C	-30°C – 60 °C [-22 °F – 140 °F], Humidity 95% or less (non-condensing), -H: -40 °C – 60 °C	-30 °C to 60 °C [-22 °F to 140 °F], humidity 95% or less (non-condensing)
Power Supply	12 VDC ± 25%, Φ 5.5 mm coaxial power plug PoE (802.3af, class 3)	12 VDC ± 25%, Φ 5.5 mm coaxial plug powerPoE(802.3af, class 3)	12 VDC ± 25%, 5.5 mm coaxial power plug PoE (802.3af, class 3)	12 VDC ± 25%, 5.5 mm coaxial power plugPoE (802.3af, class 3)	12 VDC ± 25%, Φ 5.5 mm coaxial power plug; reverse polarity protection; PoE (802.3af, class 3)
Consumption	-1S: 12 VDC, 0.6A, max. 7.5W PoE (802.3af, 37V to 57V), 0.2A to 0.1A, max. 9.5W -18: 12 VDC, 0.95A, max. 11.5W PoE (802.3af, 37V to 57V), 0.35A to 0.1A, max. 12.5W	1S:12 VDC, 0.7 A, max. 7.5 W PoE (802.3af, 36V to 57V), 0.3 A to 0.1 A, max. 9.5 W/18:12 VDC, 1 A, max: 11.5 W PoE (802.3af, 36V to 57V), 0.4 A to 0.2 A, max. 12.9 W	-1S:12 VDC, 0.5 A, max: 8 W PoE: (802.3af, 36 VDC to 57 VDC), 0.3 A to 0.1 A, max: 9.5 W -18:12 VDC, 1.0 A, max: 11 W PoE: (802.3af, 36 VDC to 57 VDC), 0.4 A to 0.1 A, max: 12.9 W	-1S:12 VDC, 0.7 A, max: 9 W PoE: (802.3af, 36 VDC to 57 VDC), 0.3 A to 0.1 A, max: 11 W-18:12 VDC, 1 A, max: 11 W PoE: (802.3af, 36 VDC to 57 VDC), 0.4 A to 0.1 A, max: 12.9 W	12 VDC, 0.88 A, max. 10.5 W; PoE (802.3af, 36 V to 57 V), 0.34 A to 0.21 A, max. 12 W
IR Range	-1S: Up to 50 m -18: Up to 80 m	1S: Up to 50 m/18: Up to 80 m	50m	80m	50m
Weatherproof	IP67	IP67	IP67	IP67	IP67
Protection level	-	-	-	-	-
Audio Input/Output	-	-	-	-	-
Alarm Input/Output	-	-	-	-	-



Short Description	8 MP IR Fixed Bullet Network Camera
Model	DS-2CD2T8662-4(4mm)
Image Sensor	1/2" Progressive Scan CMOS
Min. Illumination(Color)	0.014 Lux @ (F1.6, AGC ON), 0 Lux with IR
Lens option	4mm
Horizontal Angle of View	horizontal FOV: 87.1°, vertical FOV: 47.4°, diagonal FOV: 101.8°
Video Compression	Main stream: H.265+/H.264+/H.265/H.264 Sub-stream: H.265/H.264/MJPEG Third stream: H.265/H.264
Max. Image Resolution	3840 × 2160
WDR	120dB
Operations Conditions	-30 °C to 60 °C (-22 °F to 140 °F), humidity 95% or less (non-condensing)
Power Supply	12 VDC ± 25%, Φ 5.5 mm coaxial power plug; reverse polarity protection; PoE (802.3af, class 3)
Consumption	12 VDC, 0.88 A, max. 10.5 W; PoE (802.3af, 36 V to 57 V), 0.34 A to 0.21 A, max. 12 W
IR Range	80m
Weatherproof	IP67
Protection level	
Audio Input/Output	
Alarm Input/Output	

FIXED BULLET CAMERA









Short Description	2 MP IR Network Bullet Camera	4 MP IR Network Bullet Camera	2 MP IR Network Dome Camera	4 MP IR Network Dome Camera	2 MP IR Network Turret Camera
Model	DS-2CD102360E-I	DS-2CD104360-I	DS-2CD112360E-I	DS-2CD114360-I	DS-2CD132360E-I
Image Sensor	1/2.8" progressive scan CMOS	1/3" progressive scan CMOS	1/2.8" progressive scan CMOS	1/3" progressive scan CMOS	1/2.8" progressive scan CMOS
Min. Illumination(Color)	Color: 0.01 Lux @(F1.2, AGC ON), 0.028 Lux @ (F2.0, AGC ON)	Color: 0.01 Lux @(F1.2, AGC ON), 0.028 Lux @ (F2.0, AGC ON)	Color: 0.01 Lux @(F1.2, AGC ON), 0.028Lux @ (F2.0, AGC ON)	Color: 0.01 Lux @(F1.2, AGC ON), 0.028Lux @ (F2.0, AGC ON)	Color: 0.01 Lux @(F1.2, AGC ON), 0.028Lux @ (F2.0, AGC ON)
Lens option	2.8mm	2.8mm	2.8mm	2.8mm	4 mm
Horizontal Angle of View	Horizontal FOV 103°, vertical FOV 59°, diagonal FOV 118°	Horizontal FOV 100°, vertical FOV 55°, diagonal FOV 117°	Horizontal FOV 114°, vertical FOV 62°, diagonal FOV 135°	Horizontal FOV 100°, vertical FOV 55°, diagonal FOV 117°	Horizontal FOV 86°, vertical FOV 46°, diagonal FOV 102°
Video Compression	Main stream: H.265/H.264Sub stream: H.265/H.264/MJPEG	Main stream: H.265/H.264Sub stream: H.265/H.264/MJPEG	Main stream: H.265/H.264 Sub stream: H.265/H.264/MJPEG	Main stream: H.265/H.264 Sub stream: H.265/H.264/MJPEG	Main stream: H.265/H.264 Sub stream: H.265/H.264/MJPEG
Max. Image Resolution	1920 × 1080	2560 × 1440	1920 × 1080	2560 × 1440	1920 × 1080
WDR	Digital WDR	Digital WDR	Digital WDR	Digital WDR	Digital WDR
Operations Conditions	-30 °C to 50 °C (-22 °F to 122 °F), Humidity: 95% or less (non-condensing)	-30 °C to 50 °C (-22 °F to 122 °F), Humidity: 95% or less (non-condensing)	-30 °C to 50 °C (-22 °F to 122 °F), Humidity: 95% or less (non-condensing)	-30 °C to 50 °C (-22 °F to 122 °F), Humidity: 95% or less (non-condensing)	-30 °C to 50 °C (-22 °F to 122 °F), Humidity: 95% or less (non-condensing)
Power Supply	12 VDC ± 25%, 5.5 mm coaxial power plugPoE (802.3af, class 3)	12 VDC ± 25%, 5.5 mm coaxial power plugPoE (802.3af, class 3)	12 VDC ± 25%, 5.5 mm coaxial power plug PoE (802.3af, class 3)	12 VDC ± 25%, 5.5 mm coaxial power plug PoE (802.3af, class 3)	12 VDC ± 25%, 5.5 mm coaxial power plug PoE (802.3af, class 3)
Consumption	12 VDC, 0.4 A, Max: 5 W PoE: (802.3af, 36 V to 57 V), 0.2 A to 0.13 A, Max: 7 W	12 VDC, 0.4 A, Max: 5 W PoE: (802.3af, 36 V to 57 V), 0.2 A to 0.13 A, Max: 7 W	12 VDC, 0.4 A, Max: 5 W PoE: (802.3af, 36 V to 57 V), 0.2 A to 0.13 A, Max: 7 W	12 VDC, 0.4 A, Max: 5 W PoE: (802.3af, 36 V to 57 V), 0.2 A to 0.13 A, Max: 7 W	12 VDC, 0.4 A, Max: 5 W PoE: (802.3af, 36 V to 57 V), 0.2 A to 0.13 A, Max: 7 W
IR Range	Up to 30 m	Up to 30 m	Up to 30 m	Up to 30 m	Up to 30 m
Weatherproof	IP67	IP67	IP67	IP67	IP67
Protection level	-	-	IK10	IK10	-
Audio Input/Output	-	-	-	-	-
Alarm Input/Output	-	-	-	-	-

FIXED DOME CAMERA



FIXED TURRET CAMERA

	FIXED TURRET CAMERA	VARI-FOCAL BULLET CAMERA		VARI-FOCAL DOME CAMERA	
					
Short Description	4 MP IR Network Turret Camera	2 MP EXIR VF Bullet Network Camera	4 MP EXIR VF Bullet Network Camera	2 MP VF Network Dome Camera	4 MP VF Network Dome Camera
Model	DS-2CD134360-I	DS-2CD162360-IZ	DS-2CD164360-IZ	DS-2CD172360-IZ	DS-2CD174360-IZ
Image Sensor	1/3" progressive scan CMOS	1/2.8" Progressive Scan CMOS	1/3" Progressive Scan CMOS	1/2.8" progressive scan CMOS	1/3" progressive scan CMOS
Min. Illumination(Color)	Color: 0.01 Lux @(F1.2, AGC ON), 0.028Lux @(F2.0, AGC ON)	Color: 0.01 Lux @(F1.2, AGC ON), 0.018 Lux @(F1.6, AGC ON)	Color: 0.01 Lux @(F1.2, AGC ON), 0.018 Lux @(F1.6, AGC ON)	Color: 0.01 Lux @(F1.2, AGC ON), 0.018Lux @(F1.6, AGC ON)	Color: 0.01 Lux @(F1.2, AGC ON), 0.018 Lux @(F1.6, AGC ON)
Lens option	2.8mm	2.8-12 mm	2.8-12 mm	2.8-12 mm	2.8-12 mm
Horizontal Angle of View	Horizontal FOV 100°, vertical FOV 55°, diagonal FOV 117°	98° to 34°	Horizontal field of view: 98° to 28° Vertical field of view: 51° to 16° Diagonal field of view: 115° to 32°	98° to 34°	98° to 28°
Video Compression	Main stream: H.265/H.264 Sub stream: H.265/H.264/MJPEG	Main stream: H.265/H.264 Sub stream: H.265/H.264/MJPEG	Main stream: H.265/H.264 Sub stream: H.265/H.264/MJPEG	Main stream: H.265/H.264Sub stream: H.265/H.264/MJPEG	Main stream: H.265/H.264Sub stream: H.265/H.264/MJPEG
Max. Image Resolution	2560 × 1440	1920 × 1080	2560 × 1440	1920 × 1080	2560 × 1440
WDR	Digital WDR	Digital WDR	120dB	Digital WDR	120dB
Operations Conditions	-30 °C to 50 °C (-22 °F to 122 °F), Humidity: 95% or less (non-condensing)	-30 °C to 60 °C (-22 °F to 140 °F), Humidity: 95% or less (non-condensing)	-30 °C to 60 °C (-22 °F to 140 °F), Humidity: 95% or less (non-condensing)	-30 °C to 50 °C (-22 °F to 122 °F), Humidity: 95% or less (non-condensing)	-30 °C to 50 °C (-22 °F to 122 °F), Humidity: 95% or less (non-condensing)
Power Supply	12 VDC ± 25%, 5.5 mm coaxial power plug PoE (802.3af, class 3)	12 VDC ± 20%, 5.5 mm coaxial power plug PoE (802.3af, class 3)	12 VDC ± 20%, 5.5 mm coaxial power plug PoE (802.3af, class 3)	12 VDC ± 20%, 5.5 mm coaxial power plugPoE (802.3af, class 3)	12 VDC ± 20%, 5.5 mm coaxial power plugPoE (802.3af, class 3)
Consumption	12 VDC, 0.4 A, Max: 5 W PoE: (802.3af, 36 V to 57 V), 0.2 A to 0.13 A, Max: 7 W	12 VDC, 0.9 A, max. 11 W; PoE: (802.3af, 36 V to 57 V), 0.4 A to 0.2 A, max. 12.9 W	12 VDC, 0.9 A, max. 11 W; PoE: (802.3af, 36 V to 57 V), 0.4 A to 0.2 A, max. 12.9 W	12 VDC, 0.8 A, Max: 10 W; PoE: (802.3af, 36 V to 57 V), 0.35 A to 0.2 A, Max: 12 W	12 VDC, 0.8 A, Max: 10 W; PoE: (802.3af, 36 V to 57 V), 0.35 A to 0.2 A, Max: 12 W
IR Range	Up to 30 m	Up to 30 m	Up to 30 m	Up to 30 m	Up to 30 m
Weatherproof	IP67	IP67	IP67	IP67	IP67
Protection level	-	-	-	IK10	IK10
Audio Input/Output	-	-	-	-	-
Alarm Input/Output	-	-	-	-	-

	IP CAMERA	FIXED BULLET CAMERA	FIXED DOME CAMERA	
				
Short Description	2 MP IR Fixed Network Bullet Camera	4 MP IR Fixed Network Bullet Camera	2 MP IR Fixed Dome Network Camera	4 MP IR Fixed Network Dome Camera
Model	DS-2CD202161-IDW1	DS-2CD204161-IDW1	DS-2CD212161-IDW1	DS-2CD214161-IDW1
Image Sensor	1/2.8" Progressive Scan CMOS	1/3" Progressive Scan CMOS	1/2.8" Progressive Scan CMOS	1/3" Progressive Scan CMOS
Min. Illumination(Color)	Color: 0.01 Lux @(F1.2; AGC ON), 0.028 Lux @(F2.0; AGC ON)	Color: 0.01 Lux @(F1.2; AGC ON), 0.028 Lux @(F2.0; AGC ON)	Color: 0.01 Lux @(F1.2; AGC ON), 0.028 Lux @(F2.0; AGC ON)	Color: 0.01 Lux @(F1.2; AGC ON), 0.028 Lux @(F2.0; AGC ON)
Lens option	2.8mm	2.8/4 mm	2.8mm	2.8/4 mm
Horizontal Angle of View	Horizontal FOV: 114°, vertical FOV: 62°, diagonal FOV: 135°	2.8 mm, Horizontal FOV: 100°, vertical FOV: 55°, diagonal FOV: 117° 4 mm, Horizontal field of view: 75°, vertical FOV: 41°, diagonal FOV: 88°	Horizontal FOV: 114°, vertical FOV: 62°, diagonal FOV: 135°	2.8 mm, Horizontal FOV: 100°, vertical FOV: 55°, diagonal FOV: 117° 4 mm, Horizontal field of view: 75°, vertical FOV: 41°, diagonal FOV: 88°
Video Compression	Main stream: H.265/H.264 Sub-stream: H.265/H.264/MJPEG	Main stream: H.265/H.264 Sub stream: H.265/H.264/MJPEG	Main stream: H.265/H.264 Sub-stream: H.265/H.264/MJPEG	Main stream: H.265/H.264Sub stream: H.265/H.264/MJPEG
Max. Image Resolution		2560 × 1440		2560 × 1440
WDR	DWDR		3D DNR	
Operations Conditions	-30 °C to +60 °C (-22 °F to +140 °F), Humidity 95% or less (non-condensing)	-30 °C to +60 °C (-22 °F to +140 °F), Humidity 95% or less (non-condensing)	-30 °C to +60 °C (-22 °F to +140 °F), Humidity 95% or less (non-condensing)	-30 °C to +60 °C (-22 °F to +140 °F), Humidity 95% or less (non-condensing)
Power Supply	12 VDC ± 25%, Φ 5.5 mm coaxial plug power	12 VDC ± 25%, Φ 5.5 mm coaxial plug power	12 VDC ± 25%, Φ 5.5 mm coaxial plug power	12 VDC ± 25%, Φ 5.5 mm coaxial plug power
Consumption	12 VDC, 0.4 A, Max: 4.8W	12 VDC, 0.5 A, Max: 6W	12 VDC, 0.4 A, Max: 5W	12 VDC, 0.5 A, Max: 6W
IR Range	Up to 30 m	Up to 30 m	Up to 30 m	Up to 30 m
Weatherproof	IP66	IP66	IP66	IP66
Protection level				
Audio Input/Output	1 Built-in mic, mono sound	1 Built-in mic, mono sound	1 Built-in mic, mono sound	1 Built-in mic, mono sound
Alarm Input/Output				



TURBO HD 4.0 SOLUTION

4K AND H.265+ A NEW REVOLUTION FOR THE ANALOG WORLD

Hikvision introduced its first Turbo HD Solution in 2012, and revolutionized analog security. After years of fine-tuning and perfecting this powerful solution, Hikvision has launched Turbo HD 4.0 – a brand new revolution in high-definition, high-performance surveillance video. Turbo HD 4.0 technology gives your analog security system the powerful boost yet, upgrading the total system to amazing ultra-HD 4K resolution. Bandwidth efficiency improves by 75% using H.265+ compression. And by transmitting both HD video and power over the same coax cable, PoC technology ensures installations are faster, simpler, and less expensive.

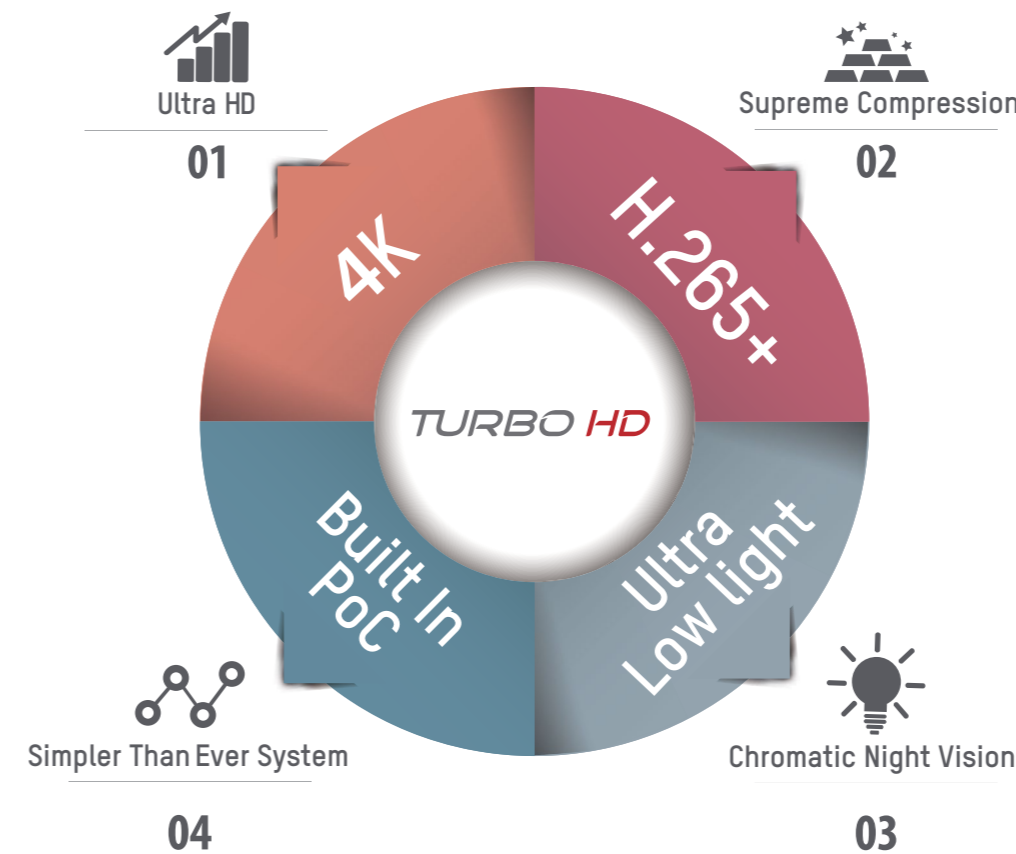

01 4K ULTRA HD

Sharp, precise, clear video can make all the difference in critical surveillance situations, enabling security staff to quickly identify suspicious individuals, objects, and movement, and take the right action at the right time.

02 H.265+ SUPREME COMPRESSION

More than three years of research and accumulation empowered Hikvision to be the first to release H.265+ on an analogue system—a revolution for analogue. H.265+ takes a huge step up in efficiency over H.264—reducing bitrates by 75% on average while maintaining high transmission quality.

03 ULTRA-LOW LIGHT CHROMATIC NIGHT VISION

Ultra-low illumination cameras from Hikvision vastly improve the efficiency of night monitoring. High-definition 1080p displays come to life with the amazing ultra-low illumination surveillance cameras. With 120 dB WDR and built-in PoC function, these cameras offer users the most advanced security features available. Rest assured that you will see what's really there - in the shadows, at night, and under conditions that leave other cameras in the dark.

04 BUILT IN PoC SIMPLER THAN EVER SYSTEM



With Hikvision's Turbo HD 4.0 Solution, installers don't have to pull wire. Power-over-coax (PoC) supplies the technology to use coaxial cable to integrate video and DC power. This innovation consists of a front-end PoC camera and a back-end Turbo HD DVR, directly embedding the PoC power supply into the back-end DVR device. It then transmits the video signal through the coaxial cable and solves the power supply problem for front-end equipment. Turbo HD 4.0 Solutions reduce the wiring area, save space and reduce the costs of labour.





TURBO HD CAMERAS





Our Turbo HD products are based on HDTV technology, an open standard enabling different products and technologies to be integrated into a single system. The products also offer many of the cutting-edge technologies on IP cameras - like Ultra-low light technology and vandal-proof capabilities.

NAME CODING RULE

DS-2	C	E	1	6	D	8	T	-IT3
Hikvision front-end product	Color camera	C: H series for project E: E series for distribution S: S series for special application	1: bullet 3: box 5: dome 7: turret	Different number means different structure	C: 720P D: 1080P F: 3Mega H: 5Mega U: 8Mega	0,1,2,3: economic rank 5,7,8,9: high-performance rank F: full-time color (common) L, C: reserved character	P: PAL N: NTSC T: HDTV	annotation: VP: vandal-proof VF: vari focal IR: conventional infrared 10-20m IR3: conventional infrared 30-40m I: enhanced conventional infrared 20m I3: enhanced conventional infrared 30m IT/IT1: EXIR 2.0 20/30m IT2: EXIR 2.0 20-40m IT3: EXIR 2.0 30-60m IT5: EXIR 2.0 60-80m WL3: white light 20-30m WL5: white light 50-80m A: AC24V and DC12V F: 4 in 1 E: PoC M: metal P: plastic Z: motorized lens H: heater

	BOX CAMERA	VARI-FOCAL BULLET CAMERA	VARI-FOCAL DOME CAMERA	FIXED BULLET CAMERA	
					
Short Description	HD1080P WDR Box Camera	HD1080P Ultra Low-Light PoC Bullet Camera	HD1080P Ultra Low-Light PoC Dome Camera	2 MP Full Time Color Bullet Camera	5 MP Full Time Color Camera
Model	DS-2CC12D9T-(A)	DS-2CC12D9T-AIT3ZE	DS-2CC52D9T-AVPIT3ZE	DS-2CE10DFT-F	DS-2CE10HFT-F
Image Sensor	2MP CMOS Image Sensor	2MP progressive scan CMOS	2MP progressive scan CMOS	2 MP CMOS image sensor	5 MP CMOS
Lens		2.8 mm-12 mm	2.8 mm-12 mm	3.6 mm, 6 mm fixed lens	3.6 mm, fixed lens
Day & Night	ICR	ICR	ICR	Color	Color
Operating Conditions	-30 °C – 60 °C (-22 °F – 140 °F), Humidity 90% or less (non-condensing)	-40 °C to 60 °C (-40 °F to 140 °F), humidity: 90% or less (no condensation)	-40 °C to 60 °C (-40 °F to 140 °F), humidity: 90% or less (no condensation)	-40 °C to 60 °C (-40 °F to 140 °F), humidity: 90% or less (non-condensation)	-40 °C to 60 °C (-40 °F to 140 °F), humidity: 90% or less (non-condensation)
Power Supply	24V±15% AC, 12V±15% DC	24 VAC/12 VDC ±30%/PoC.at	24 VAC/12 VDC ±30%/PoC.at	12 VDC ±25%	12 VDC ±25%*You are recommended to use one power adapter to supply the power for one camera.
Power Consumption	Max. 6W	Max. 7.5 W	Max. 6 W	Max. 3 W	Max. 3.5 W
Protection Level		IP67	IP67	IP67	IP67
IR Range		Up to 40 m	Up to 40 m		-
Dimensions	69.2×57.3×148.7mm(2.7" × 2.3" × 5.85")	92 mm × 85.3 mm × 269.6 mm (3.62" × 3.36" × 10.61")	Φ 145.2 mm × 124.1 mm (7.1" × 4.9")	181.4 mm × 70 mm × 68 mm (7.14" × 2.75" × 2.68")	68 mm × 70 mm × 168.2 mm (2.68" × 2.76" × 6.62")
Weight	520 g	Approx. 700 g (1.54 lb.)	Approx. 2000 g (4.4 lb.)	Approx. 390 g (0.86 lb.)	Approx. 350 g (0.77 lb.)
Appearance	Box	Bullet	Outdoor Dome	Bullet	
Effective Pixels	1944(H)*1092(V)	1920 (H)*1080 (V)	1920 (H)*1080 (V)	1920 (H) × 1080 (V)	2560 (H) × 1944 (V)
Min. illumination	Color : 0.01 Lux @(F1.2,AGC ON); B/W : 0.001 Lux @(F1.2,AGC ON)	0.003 Lux@(F1.2, AGC ON), 0 Lux with IR	0.003 Lux@(F1.2, AGC ON), 0 Lux with IR	0.0005 Lux @ (F1.0, AGC ON), 0 Lux with white light	Color: 0.0005 Lux @ (F1.0, AGC ON), 0 Lux with White Light
Angle Adjustment		Pan: 0-360°, Tilt: 0-90°, Rotate: 0-360°	Pan: 0-355°, Tilt: 0-75°, Rotate: 0-355°	Pan: 0° to 360°; Tilt: 0° to 180°; Rotate: 0° to 360°	Pan: 0 to 360°, Tilt: 0 to 90°, Rotation: 0 to 360°
WDR	120dB	> 120 dB	> 120 dB	120 dB	≥130 dB
Video Frame Rate	1080p@25fps	1080p@25fps	1080p@25fps	PAL: 1080p@25fps NTSC: 1080p@30fps	TVI: 5MP@20fps, 4MP@30fps, 4MP@25fps, 1080p@30fps, 1080p@25fps CVI: 4MP@30fps, 4MP@25fps AHD: 5MP@20fps, 4MP@30fps, 4MP@25fps CVBS: PAL/NTSC
HD Video Output	1 Analog HD output	1 Analog HD output/1 CVBS output (75Ω/BNC)	1 Analog HD output	Switchable TVI/AHD/CVI/CVBS	Switchable TVI/AHD/CVI/CVBS
CVBS Output	1Vp-p Composite Output(75Ω/BNC)		/1 CVBS output (75Ω/BNC)		
Camera ID					

				VARI-FOCAL BULLET CAMERA 	FIXED BULLET CAMERA 
Short Description	2 MP Full Time Color Bullet Camera	2 MP PIR Siren Full Time Color Camera	5 MP Full Time Color Camera	2 MP Ultra-Low Light Bullet Camera	2 MP Ultra Low-Light PoC EXIR Bullet Camera
Model	DS-2CE12DFT-F	DS-2CE12DFT-PIRX0F	DS-2CE12HFT-F	DS-2CE16D8T-(A)IT3ZF	DS-2CE16D8T-IT3/5E
Image Sensor	2 MP CMOS image sensor	2 MP CMOS	5 MP CMOS	2.0 megapixel progressive scan CMOS	2 MP progressive scan CMOS
Lens	3.6mm	3.6 mm, fixed lens	3.6 mm, fixed lens	2.7 mm to 13.5 mm motorized, auto focus	2.8mm
Day & Night	Color	Color	Color	IR cut filter	IR cut filter
Operating Conditions	-40 °C to 60 °C [-40 °F to 140 °F], humidity: 90% or less (non-condensation)	-40 °C to 60 °C [-40 °F to 140 °F], humidity: 90% or less (non-condensation)	-40 °C to 60 °C [-40 °F to 140 °F], humidity: 90% or less (non-condensation)	-40 °C – 60 °C [-40 °F – 140 °F], Humidity 90% or less (non-condensing)	-40 °C to 60 °C [-40 °F to 140 °F], humidity: 90% or less (non-condensation)
Power Supply	12 VDC ± 25%	12 VDC ±25%*You are recommended to use one power adapter to supply the power for one camera.	12 VDC ±25%*You are recommended to use one power adapter to supply the power for one camera.	12 VDC ±25%, 24 VAC±25%	12 VDC±25%/PoC.af
Power Consumption	Max. 4.2 W	Max. 8.5 W	Max. 4.9 W	Max. 7.5W, -A: Max. 9W	Max. 4W
Protection Level	IP67	IP67	IP67	IP67	IP67
IR Range	Up to 40 m	-	-	Up to 60 m	Up to 20 m
Dimensions	223.1 mm × 77.1 mm × 82.6 mm (8.78" × 3.04" × 3.25")	77.1 mm × 82.6 mm × 208.9 mm (3.04" × 3.25" × 8.22")	82.6 mm × 77.1 mm × 215.7 mm (3.25" × 3.04" × 8.49")	85 mm × 92 mm × 269.6 mm (3.3" × 3.6" × 10.6")	86.7 mm × 81.6 mm × 226 mm (3.41" × 3.23" × 8.67")
Weight	Approx. 436 g (0.96 lb.)	Approx. 441 g (0.97 lb.)	Approx. 535 g (1.18 lb.)	Approx. 910 g (2.01 lb.), -A: Approx. 940 g (2.07 lb.)	Approx. 680 g (1.5 lb.)
Appearance	Bullet				Bullet
Effective Pixels	1920 (H) × 1080 (V)	1920 (H) × 1080 (V)	2560 (H) × 1944 (V)	1920 (H) × 1080 (V)	1920 (H) × 1080 (V)
Min. illumination	Color: 0.0005 Lux @ (F1.0, AGC ON), 0 Lux with white light	Color: 0.0005 Lux @ (F1.0, AGC ON), 0 Lux with White Light	Color: 0.0005 Lux @ (F1.0, AGC ON), 0 Lux with White Light	Color: 0.003 Lux @ (F1.2, AGC ON), 0 Lux with IR	Color: 0.005 Lux @ (F2.0, AGC ON), 0 Lux with IR
Angle Adjustment	Pan: 0° to 360°; Tilt: 0° to 180°; Rotate: 0° to 360°	Pan: 0 to 360°, Tilt: 0 to 90°, Rotation: 0 to 360°	Pan: 0 to 360°, Tilt: 0 to 90°, Rotation: 0 to 360°	Pan: 0° to 360°, Tilt: 0° to 90°, Rotate: 0° to 360°	Pan: 0-360°, Tilt:0-90°, Rotate: 0-360°
WDR	130 dB	≥130 dB	≥130 dB	≥ 130 dB	> 120 dB
Video Frame Rate	PAL: 1080p@25fps NTSC: 1080p@30fps	TVI: 1080p@30fps, 1080p@25fps AHD: 1080p@30fps, 1080p@25fps CVI: 1080p@30fps, 1080p@25fps CVBS: PAL/NTSC	TVI: 5MP@20fps, 4MP@30fps, 4MP@25fps, 1080p@30fps, 1080p@25fps CVI: 4MP@30fps, 4MP@25fps AHD: 5MP@20fps, 4MP@30fps, 4MP@25fps CVBS: PAL/NTSC	PAL: 1080p@25fps NTSC: 1080p@30fps	1080p@25fps
HD Video Output	TVI/AHD/CVI/CVBS	Switchable TVI/AHD/CVI/CVBS	Switchable TVI/AHD/CVI/CVBS	Switchable TVI/AHD/CVI/CVBS	1 HD output
CVBS Output					
Camera ID					

				VARI-FOCAL BULLET CAMERA 	FIXED BULLET CAMERA 
Short Description	2 MP Ultra Low-Light PoC VF EXIR Bullet Camera	2 MP Ultra Low-Light PoC EXIR Bullet Camera	2 MP Ultra-Low Light Bullet Camera	HD1080P WDR Motorized VF EXIR Bullet Camera	5 MP Bullet Camera
Model	DS-2CE16D8T-IT3ZE	DS-2CE16D8T-ITE	DS-2CE16D8T-ITF/3F/5F	DS-2CE16D9T-AIRAZH	DS-2CE16H8T-IT3F
Image Sensor	2MP progressive scan CMOS	2 MP progressive scan CMOS	2.0 megapixel progressive scan CMOS	2MP CMOS Image Sensor	5 megapixel progressive scan CMOS
Lens	2.8 mm-12 mm	2.8mm	3.6 mm, 6 mm, 8 mm, 12 mm fixed lens	5-50mm	2.8 mm, 3.6 mm, 6 mm, 8 mm, 12 mm fixed lens
Day & Night	ICR	IR cut filter	IR cut filter	ICR	IR cut filter
Operating Conditions	-40° C to 60° C [-40° F to 140° F], humidity: 90% or less (no condensation)	-40 °C to 60 °C [-40 °F to 140 °F], humidity: 90% or less (non-condensation)	-40 °C – 60 °C [-40 °F – 140 °F], Humidity 90% or less (non-condensing)	-40 °C – 60 °C [-40 °F – 140 °F], Humidity 90% or less (non-condensing)	-40 °C – 60 °C [-40 °F – 140 °F], Humidity 90% or less (non-condensing)
Power Supply	12 VDC ±25%/PoC.at	12 VDC±25%/PoC.af	12 VDC ±25%	AC24V±15%/ DC12V±15%, Heater is available with 24VAC only	12 VDC ±25%
Power Consumption	Max. 8.2 W	Max. 4W	Max. 5.2 W	Max. 20W	Max. 5.8 W
Protection Level	IP67	IP67	IP67	IP66	IP67
IR Range	Up to 40 m	Up to 20 m	Up to 80 m	Up to 110m	Up to 60 m
Dimensions	92 mm × 89 mm × 269.6 mm (3.62" × 3.5" × 8.34")	58 mm × 61 mm × 163 mm (2.28" × 2.40" × 6.42")	81.6 mm × 86.7 mm × 226 mm (3.2" × 3.4" × 8.9")	313.5x100.8x107.3mm	81.9 mm × 86.7 mm × 217.9 mm (3.22" × 3.41" × 8.58")
Weight	Approx. 900 g (1.98 lb.)	Approx. 350 g (0.77 lb.)	Approx. 560 g (1.23 lb.)	1650g	Approx. 570 g (1.26 lb.)
Appearance	Bullet	Bullet		Bullet	
Effective Pixels	1920 (H) × 1080 (V)	1920 (H) × 1080 (V)	1920 (H) × 1080 (V)	1944(H) × 1092(V)	2560 (H) × 1944 (V)
Min. illumination	0.005 Lux @ (F1.2 AGC ON), 0 Lux with IR	Color: 0.005 Lux @ (F2.0, AGC ON), 0 Lux with IR	Color: 0.003 Lux @ (F1.2, AGC ON), 0 Lux with IR	0.01Lux @ (F1.2,AGC ON),0 Lux with IR	Color: 0.003 Lux@(F1.2, AGC ON), 0 Lux with IR
Angle Adjustment	Pan: 0-360°, Tilt: 0-90°, Rotation: 0-360°	Pan: 0-360°, Tilt:0-90°, Rotate: 0-360°	Pan: 0° to 360°, Tilt: 0° to 180, Rotate: 0° to 360°	Pan: 0° – 360°; Tilt:0° – 90°; Rotate: 0° – 360°	Pan: 0° to 360°; Tilt: 0° to 75°; Rotate: 0° to 360°
WDR	> 120 dB	> 120 dB	≥ 130 dB	120dB	≥ 130 dB
Video Frame Rate	1080p@25fps	1080p@25fps	PAL: 1080p@25fps NTSC: 1080p@30fps	1080p@25fps	TVI: 2 MP@25fps, 2 MP@30fps, 4 MP@25fps, 4 MP@30fps, 5 MP@20fps AHD: 4 MP@25fps, 4 MP@30fps, 5 MP@20fps CVI: 4 MP@25fps, 4 MP@30fps CVBS: PAL, NTSC
HD Video Output	1 Analog HD output	1 HD output	Switchable TVI/AHD/CVI/CVBS	1 Analog HD output	Switchable TVI/AHD/CVI/CVBS
CVBS Output					
Camera ID					

VARI-FOCAL BULLET CAMERA



Short Description	5 MP Bullet Camera	5 MP Bullet Camera	Turbo HD 4K Bullet Camera	Turbo HD 4K Bullet Camera	5 MP Bullet Camera
Model	DS-2CE16H8T-ITSF	DS-2CE16H8T-ITF	DS-2CE16U1T-IT3F	DS-2CE16U1T-ITF	DS-2CE19H8T-(A)IT3ZF
Image Sensor	5 megapixel progressive scan CMOS	5 megapixel progressive scan CMOS	8.29 megapixel progressive scan CMOS	8.29 megapixel progressive scan CMOS	5 megapixel progressive scan CMOS
Lens	3.6 mm, 6 mm, 8 mm, 12 mm fixed lens	2.8 mm, 3.6 mm, 6 mm fixed lens	2.8 mm, fixed lens	2.8 mm, fixed lens	2.7 mm to 13.5 mm motorized vari-focal lens
Day & Night	IR cut filter	IR cut filter	IR cut filter	IR cut filter	IR cut filter
Operating Conditions	-40 °C – 60 °C (-40 °F – 140 °F), Humidity 90% or less (non-condensing)	-40 °C – 60 °C (-40 °F – 140 °F), Humidity 90% or less (non-condensing)	-40 °C to 60 °C (-40 °F to 140 °F), humidity: 90% or less (non-condensation)	-40 °C to 60 °C (-40 °F to 140 °F), humidity: 90% or less (non-condensation)	-40 °C – 60 °C (-40 °F – 140 °F), Humidity 90% or less (non-condensing)
Power Supply	12 VDC ±25%	12 VDC ±25%	12 VDC ±25% *You are recommended to use one power adapter to supply the power for one camera.	12 VDC ±25% *You are recommended to use one power adapter to supply the power for one camera.	-A: 9.6 VDC to 14.4 VDC; 19.2 VAC to 28.8 VAC
Power Consumption	Max. 5.8 W	Max. 5.8 W	Max. 5.3 W	Max. 5.3 W	-A: Max. 10.5 W
Protection Level	IP67	IP67	IP67	IP67	IP67
IR Range	Up to 80 m	Up to 30 m	Up to 60 m	Up to 30 m	Up to 80 m
Dimensions	81.9 mm × 86.7 mm × 217.9 mm (3.22" × 3.41" × 8.58")	58 mm × 61 mm × 158.6 mm (2.28" × 2.40" × 6.42")	81.9 mm × 86.7 mm × 217.9 mm (3.22" × 3.41" × 8.58")	81.9 mm × 86.7 mm × 217.9 mm (3.22" × 3.41" × 8.58")	84.5 mm × 92 mm × 255.1 mm (3.33" × 3.62" × 10")
Weight	Approx. 570 g (1.26 lb.)	Approx. 320 g (0.71 lb.)	Approx.435 g (0.96 lb.)	Approx.435 g (0.96 lb.)	Approx. 930 g (2.05 lb.)
Appearance					
Effective Pixels	2560 (H) × 1944 (V)	2560 (H) × 1944 (V)	3840 (H) × 2160 (V)	3840 (H) × 2160 (V)	2560 (H) × 1944 (V)
Min. illumination	Color: 0.003 Lux@(F1.2, AGC ON), 0 Lux with IR	Color: 0.003 Lux@(F1.2, AGC ON), 0 Lux with IR	Color: 0.01 Lux@(F1.2, AGC ON), 0 Lux with IR	Color: 0.01 Lux@(F1.2, AGC ON), 0 Lux with IR	Color: 0.003 Lux@(F1.2, AGC ON), 0 Lux with IR
Angle Adjustment	Pan: 0° to 360°; Tilt: 0° to 75°; Rotate: 0° to 360°	Pan: 0° to 360°; Tilt: 0° to 75°; Rotate: 0° to 360°	Pan: 0° to 360°, Tilt:0° to 180°, Rotate: 0° to 360°	Pan: 0° to 360°, Tilt:0° to 180°, Rotate: 0° to 360°	Pan: 0° to 360°; Tilt: 0° to 75°; Rotate: 0° to 360°
WDR	≥ 130 dB	≥ 130 dB	105 dB	105 dB	≥ 130 dB
Video Frame Rate	TVI: 2 MP@25fps, 2 MP@30fps, 4 MP@25fps, 4 MP@30fps, 5 MP@20fps AHD: 4 MP@25fps, 4 MP@30fps, 5 MP@20fps CVI: 4 MP@25fps, 4 MP@30fps CVBS: PAL, NTSC	TVI: 2 MP@25fps, 2 MP@30fps, 4 MP@25fps, 4 MP@30fps, 5 MP@20fps AHD: 4 MP@25fps, 4 MP@30fps, 5 MP@20fps CVI: 4 MP@25fps, 4 MP@30fps CVBS: PAL, NTSC	TVI: 8MP@12.5fps, 8MP@15fps, 5MP@20fps, 4MP@25fps, 4MP@30fps, 2MP@25fps, 2MP@30fps CVI: 8MP@12.5fps, 8MP@15fpsAHD: 8M@12.5fps, 8M@15fpsCVBS: 960H P/N	TVI: 8MP@12.5fps, 8MP@15fps, 5MP@20fps, 4MP@25fps, 4MP@30fps, 2MP@25fps, 2MP@30fps CVI: 8MP@12.5fps, 8MP@15fpsAHD: 8M@12.5fps, 8M@15fpsCVBS: 960H P/N	TVI: 2 MP@25fps, 2 MP@30fps, 4 MP@25fps, 4 MP@30fps, 5 MP@20fps AHD: 4 MP@25fps, 4 MP@30fps, 5 MP@20fps CVI: 4 MP@25fps, 4 MP@30fps CVBS: PAL, NTSC
HD Video Output	Switchable TVI/AHD/CVI/CVBS	Switchable TVI/AHD/CVI/CVBS	Switchable TVI/AHD/CVI/CVBS	Switchable TVI/AHD/CVI/CVBS	Switchable TVI/AHD/CVI/CVBS
CVBS Output					
Camera ID					

VARI-FOCAL DOME CAMERA



Short Description	8 MP Bullet Camera	2 MP Ultra-Low Light Dome Camera	2 MP Ultra-Low Light EXIR Turret Camera	2 MP Ultra Low-Light PoC EXIR Turret Camera	2 MP Ultra-Low Light VF PoC Turret Camera
Model	DS-2CE19U7T-AIT3ZF	DS-2CE56D8T-(A)VPIT3ZF	DS-2CE56D8T-IT1F/3F	DS-2CE56D8T-IT3E	DS-2CE56D8T-IT3ZE
Image Sensor	8.29 megapixel progressive scan CMOS	2.0 megapixel progressive scan CMOS	2.0 megapixel progressive scan CMOS	2 MP progressive scan CMOS	2.0 megapixel progressive scan CMOS
Lens	2.7 mm to 13.5 mm motorized vari-focal lens	2.7 mm to 13.5 mm motorized, auto focus	2.8 mm, 3.6 mm, 6 mm, 8 mm, 12 mm fixed focal lens	2.8mm	2.8 mm to 12 mm motorized vari-focal lens
Day & Night	IR cut filter	IR cut filter	IR cut filter	IR cut filter	IR cut filter
Operating Conditions	-40 °C – 60 °C (-40 °F – 140 °F), Humidity 90% or less (non-condensing)	-40 °C – 60 °C (-40 °F – 140 °F), Humidity 90% or less (non-condensing)	-40 °C – 60 °C (-40 °F – 140 °F), Humidity 90% or less (non-condensing)	-40 °C to 60 °C (-40 °F to 140 °F), humidity: 90% or less (non-condensation)	-40 °C – 60 °C (-40 °F – 140 °F), Humidity 90% or less (non-condensing)
Power Supply	9.6 VDC to 14.4 VDC; 19.2 VAC to 28.8 VAC	12 VDC ±25%, 24 VAC±25%	12 VDC ±25%	12 VDC±25%/PoC.af	12 VDC ±25%/PoC.at
Power Consumption	Max. 11.8 W	Max. 5.8W, -A: Max. 7.5W	Max. 3.4 W	Max. 4W	Max. 7.5 W
Protection Level	IP67	IK10	IP67	IP67	IP67
IR Range	Up to 80 m	Up to 60 m	Up to 60 m	Up to 40 m	Up to 40 m
Dimensions	84.5 mm × 92 mm × 255.1 mm (3.33" × 3.62" × 10")	Φ 145.2 mm × 124.1 mm (Φ 7.1" × 4.9")	Ø 110 mm × 93.2 mm (Φ 4.33" × 3.67")	Φ 110 mm × 93.2 mm (Φ 4.33" × 3.67")	134.3 mm × 123.9 mm × 111.4 mm (5.29" × 4.88" × 4.39")
Weight	Approx. 925 g (2.04 lb.)	Approx. 610 g (1.34 lb.), -A: Approx. 640 g (1.41 lb.)	Approx. 315 g (0.69 lb.)	350 g (0.77 lb.)	Approx. 750 g (1.57 lb.)
Appearance				Turret	Turret
Effective Pixels	3840 (H) × 2160 (V)	1920 (H) × 1080 (V)	1920 (H) × 1080 (V)	1920 (H) × 1080 (V)	1920 (H) × 1080 (V)
Min. illumination	Color: 0.003 Lux@(F1.2, AGC ON), 0 Lux with IR	Color: 0.003 Lux @ (F1.2, AGC ON), 0 Lux with IR	Color: 0.003 Lux @ (F1.2, AGC ON), 0 Lux with IR	Color: 0.005 Lux @ (F2.0, AGC ON), 0 Lux with IR	Color: 0.005 Lux @ (F1.2, AGC ON), 0 Lux with IR
Angle Adjustment	Pan: 0° to 360°; Tilt: 0° to 90°; Rotate: 0° to 360°	Pan: 0° to 355°, Tilt: 0° to 75°, Rotate: 0° to 355°	Pan: 0° to 360°, Tilt: 0° to 75°, Rotate: 0° to 360°	Pan: 0-360°, Tilt:0-90°, Rotate: 0-360°	Pan: 0° to 360°; Tilt: 0° to 90°; Rotate: 0° to 360°
WDR	≥ 130 dB	≥ 130 dB	≥ 130 dB	> 120 dB	> 120 dB
Video Frame Rate	TVI: 8MP@12.5fps, 8MP@15fps, 5MP@20fps, 4MP@25fps, 4MP@30fps, 2MP@25fps, 2MP@30fps CVI: 8MP@12.5fps, 8MP@15fpsAHD: 8M@12.5fps, 8M@15fps CVBS: PAL, NTSC	PAL: 1080p@25fps NTSC: 1080p@30fps	PAL: 1080p@25fps NTSC: 1080p@30fps	1080p@25fps	PAL: 1080p@25fps NTSC: 1080p@30fps
HD Video Output	Switchable TVI/AHD/CVI/CVBS	Switchable TVI/AHD/CVI/CVBS	Switchable TVI/AHD/CVI/CVBS	1 HD output	1 HD analog output
CVBS Output					
Camera ID					

VARI-FOCAL TURRET CAMERA

FIXED TURRET CAMERA



Short Description	2 MP Full Time Color Turret Camera	2 MP Full Time Color Camera	2 MP PIR Siren Full Time Color Camera	2 MP PIR Siren Full Time Color Camera	5 MP Full Time Color Camera
Model	DS-2CE72DFT-F	DS-2CE72DFT-F28	DS-2CE72DFT-PIRX0F	DS-2CE72DFT-PIRX0F28	DS-2CE72HFT-F
Image Sensor	2 MP CMOS image sensor	2 MP CMOS	2 MP CMOS	2 MP CMOS	5 MP CMOS
Lens	3.6 mm, 6 mm fixed lens	2.8 mm fixed lens	3.6 mm, fixed lens	2.8 mm fixed lens	3.6 mm, fixed lens
Day & Night	Color	Color	Color	Color	Color
Operating Conditions	-40 °C to 60 °C (-40 °F to 140 °F), humidity: 90% or less (non-condensation)	-40 °C to 60 °C (-40 °F to 140 °F), humidity: 90% or less (non-condensing)	-40 °C to 60 °C (-40 °F to 140 °F), humidity: 90% or less (non-condensation)	-40 °C to 60 °C (-40 °F to 140 °F), humidity: 90% or less (non-condensing)	-40 °C to 60 °C (-40 °F to 140 °F), humidity: 90% or less (non-condensation)
Power Supply	12 VDC ±25%	12 VDC ± 25%	12 VDC ±25% *You are recommended to use one power adapter to supply the power for one camera.	12 VDC ± 25%	12 VDC ±25% *You are recommended to use one power adapter to supply the power for one camera.
Power Consumption	Max. 3 W	Max. 3W	Max. 6.6 W	Max. 6.6W	Max. 3.5 W
Protection Level	IP67	IP67	IP67	IP67	IP67
IR Range			-		-
Dimensions	∅ 109.82 mm × 85.56 mm (∅ 4.32" × 3.37")	∅ 109.82 mm × 85.56 mm (∅ 4.32" × 3.37")	∅ 109.82 mm × 93.66 mm (∅ 4.32" × 3.7")	∅ 109.82 mm × 93.66 mm (∅ 4.32" × 3.7")	∅ 109.82 mm × 85.56 mm (4.32" × 3.37")
Weight	Approx. 336 g (0.74 lb.)	Approx. 336 g (0.74 lb.)	Approx. 390 g (0.86 lb.)	Approx. 390 g (0.86 lb.)	Approx. 350 g (0.77 lb.)
Appearance	Turret	Turret		Turret	
Effective Pixels	1920 (H) × 1080 (V)	1920 (H) × 1080 (V)	1920 (H) × 1080 (V)	1920 (H) × 1080 (V)	2560 (H) × 1944 (V)
Min. illumination	Color: 0.0005 Lux @ (F1.0, AGC ON), 0 Lux with white light	0.0005 Lux @ (F1.0, AGC ON), 0 Lux with white light	Color: 0.0005 Lux @ (F1.0, AGC ON), 0 Lux with White Light	0.0005 Lux @ (F1.0, AGC ON), 0 Lux with white light	Color: 0.0005 Lux @ (F1.0, AGC ON), 0 Lux with White Light
Angle Adjustment	Pan: 0° to 360°; Tilt: 0° to 75°; Rotate: 0° to 360°	Pan: 0° to 360°; Tilt: 0° to 75°; Rotate: 0° to 360°	Pan: 0 to 360°, Tilt: 0 to 75°, Rotation: 0 to 360°	Pan: 0 to 360°, Tilt: 0 to 75°, Rotation: 0 to 360°	Pan: 0 to 360°, Tilt: 0 to 75°, Rotation: 0 to 360°
WDR	120 dB	130 dB	≥130 dB	130 dB	≥130 dB
Video Frame Rate	PAL: 1080p@25fpsNTSC: 1080p@30fps	PAL: 1080p@25fpsNTSC: 1080p@30fps	TVI: 1080p@30fps, 1080p@25fps AHD: 1080p@30fps, 1080p@25fps CVI: 1080p@30fps, 1080p@25fps CVBS: PAL/NTSC	TVI: 1080p@30fps, 1080p@25fps AHD: 1080p@30fps, 1080p@25fps CVI: 1080p@30fps, 1080p@25fps CVBS: PAL/NTSC	TVI: 5MP@20fps, 4MP@30fps, 4MP@25fps, 1080p@30fps, 1080p@25fps CVI: 4MP@30fps, 4MP@25fps AHD: 5MP@20fps, 4MP@30fps, 4MP@25fps CVBS: PAL/NTSC
HD Video Output	Switchable TVI/AHD/CVI/CVBS		Switchable TVI/AHD/CVI/CVBS		Switchable TVI/AHD/CVI/CVBS
CVBS Output					
Camera ID					

Short Description	5 MP Full Time Color Camera	5 MP Turret Camera	Turbo HD 4K Turret Camera	5 MP Turret Camera	Turbo HD 4K Turret Camera
Model	DS-2CE72HFT-F28	DS-2CE76H8T-ITMF	DS-2CE76U1T-ITMF	DS-2CE78H8T-IT3F	DS-2CE78U1T-IT3F
Image Sensor	5 MP CMOS	5 megapixel progressive scan CMOS	8.29 megapixel progressive scan CMOS	5 megapixel progressive scan CMOS	8.29 megapixel progressive scan CMOS
Lens	2.8 mm fixed lens	2.8 mm, 3.6 mm, 6 mm fixed lens	2.8 mm, fixed lens	2.8 mm, 3.6 mm, 6 mm, 8 mm, 12 mm fixed lens	2.8 mm, fixed lens
Day & Night	Color	IR cut filter	IR cut filter	IR cut filter	IR cut filter
Operating Conditions	-40 °C to 60 °C (-40 °F to 140 °F), humidity: 90% or less (non-condensing)	-40 °C – 60 °C (-40 °F – 140 °F), Humidity: 90% or less (non-condensing)	-40 °C to 60 °C (-40 °F to 140 °F), humidity: 90% or less (non-condensation)	-40 °C – 60 °C (-40 °F – 140 °F), Humidity: 90% or less (non-condensing)	-40 °C to 60 °C (-40 °F to 140 °F), humidity: 90% or less (non-condensation)
Power Supply	12 VDC ± 25%	12 VDC ±25%	12 VDC ±25% *You are recommended to use one power adapter to supply the power for one camera.	12 VDC ±25%	12 VDC ±25% *You are recommended to use one power adapter to supply the power for one camera.
Power Consumption	Max. 3.5 W	Max. 5.8 W	Max. 5.3 W	Max. 5.8 W	Max. 5.3 W
Protection Level	IP67	IP67	IP67	IP67	IP67
IR Range		Up to 30 m	Up to 30 m	Up to 60 m	Up to 60 m
Dimensions	∅ 109.82 mm × 85.56 mm (4.32" × 3.37")	90 mm × 79.37 mm (3.54" × 3.12")	90 mm × 79.37 mm (3.54" × 3.12")	∅ 109.82 mm × 91.03 mm (∅ 4.32" × 3.6")	∅ 109.82 mm × 91.03 mm (∅ 4.32" × 3.6")
Weight	Approx. 350 g (0.77 lb.)	Approx. 300 g (0.66 lb.)	Approx. 310 g (0.68 lb.)	Approx. 310 g (0.68 lb.)	Approx. 320 g (0.71 lb.)
Appearance	Turret				
Effective Pixels	2560 (H) × 1944 (V)	2560 (H) × 1944 (V)	3840 (H) × 2160 (V)	2560 (H) × 1944 (V)	3840 (H) × 2160 (V)
Min. illumination	0.0005 Lux @ (F1.0, AGC ON), 0 Lux with White Light	Color: 0.003 Lux@(F1.2, AGC ON), 0 Lux with IR	Color: 0.01 Lux@(F1.2, AGC ON), 0 Lux with IR	Color: 0.003 Lux@(F1.2, AGC ON), 0 Lux with IR	Color: 0.01 Lux@(F1.2, AGC ON), 0 Lux with IR
Angle Adjustment	Pan: 0 to 360°, Tilt: 0 to 75°, Rotation: 0 to 360°	Pan: 0° to 360°; Tilt: 0° to 75°; Rotate: 0° to 360°	Pan: 0° to 360°, Tilt:0° to 180°, Rotate: 0° to 360°	Pan: 0° to 360°; Tilt: 0° to 75°; Rotate: 0° to 360°	Pan: 0° to 360°, Tilt:0° to 180°, Rotate: 0° to 360°
WDR	130 dB	≥ 130 dB	105 dB	≥ 130 dB	105 dB
Video Frame Rate	TVI: 5MP@20fps, 4MP@30fps, 4MP@25fps, 1080p@30fps, 1080p@25fps CVI: 4MP@30fps, 4MP@25fps AHD: 5MP@20fps, 4MP@30fps, 4MP@25fps CVBS: PAL/NTSC	TVI: 2 MP@25fps, 2 MP@30fps, 4 MP@25fps, 4 MP@30fps, 5 MP@20fps AHD: 4 MP@25fps, 4 MP@30fps, 5 MP@20fps CVI: 4 MP@25fps, 4 MP@30fps CVBS: PAL, NTSC	TVI: 8MP@12.5fps, 8MP@15fps, 5MP@20fps, 4MP@25fps, 4MP@30fps, 2MP@25fps, 2MP@30fpsCVI: 8MP@12.5fps, 8MP@15fpsAHD: 8M@12.5fps, 8M@15fpsCVBS: 960H P/N	TVI: 2 MP@25fps, 2 MP@30fps, 4 MP@25fps, 4 MP@30fps, 5 MP@20fps AHD: 4 MP@25fps, 4 MP@30fps, 5 MP@20fps CVI: 4 MP@25fps, 4 MP@30fps CVBS: PAL, NTSC	TVI: 8MP@12.5fps, 8MP@15fps, 5MP@20fps, 4MP@25fps, 4MP@30fps, 2MP@25fps, 2MP@30fpsCVI: 8MP@12.5fps, 8MP@15fpsAHD: 8M@12.5fps, 8M@15fpsCVBS: 960H P/N
HD Video Output	Switchable TVI/AHD/CVI/CVBS		Switchable TVI/AHD/CVI/CVBS	Switchable TVI/AHD/CVI/CVBS	Switchable TVI/AHD/CVI/CVBS
CVBS Output					
Camera ID					

VARI-FOCAL TURRET CAMERA



PINHOLE CAMERA



Short Description	5 MP Turret Camera	8 MP Ultra-Low Light Camera	2 MP WDR Covert Camera
Model	DS-2CE79H8T-AIT3ZF	DS-2CE79U7T-AIT3ZF	DS-2CS54D8T-PH
Image Sensor	5 MP CMOS	8.29 MP CMOS	2 MP progressive scan CMOS
Lens	2.7 mm to 13.5 mm motorized vari-focal lens	2.7-13.5mm	3.7 mm
Day & Night	IR cut filter	ICR	Electronic
Operating Conditions	-40 °C to 60 °C (-40 °F to 140 °F), humidity: 90% or less (non-condensation)	-40 °C to 60 °C (-40 °F to 140 °F), humidity: 90% or less (non-condensing)	-40° C to 60° C (-40° F to 140° F), Humidity 90% or less (no condensation)
Power Supply	12 VDC ± 20%, 24 VAC ± 20%	12 VDC ± 20%, 24 VAC ± 20%	12 VDC ±20%
Power Consumption	Max. 10.5 W	Max. 11 W	Max. 1.5 W
Protection Level	IP67	IP67	
IR Range	Up to 60 m	Up to 60 m	
Dimensions	123.86 mm × 134.3 mm × 110.24 mm (4.88" × 5.29" × 4.34")	134.3 mm × 123.86 mm × 110.24 mm (5.29" × 4.88" × 4.34")	32.4 mm × 32.4 mm × 22.0 mm (1.28" × 1.28" × 0.87")
Weight	Approx. 630 g (1.39 lb.)	Approx. 620 g (1.37 lb.)	Approx. 200 g (0.44 lb.)
Appearance	Turret	Turret	
Effective Pixels	2560 (H) × 1944 (V)	3840 (H) × 2160 (V)	1920 (H) × 1080 (V)
Min. illumination	0.003 Lux @ (F1.2, AGC ON), 0 Lux with IR	0.003 Lux@(F1.2, AGC ON), 0 Lux with IR	0.005 Lux @ (F1.2, AGC ON), 0 Lux with IR
Angle Adjustment	Pan: 0° to 360°; Tilt: 0° to 75°; Rotate: 0° to 360°	Pan: 0° to 360°; Tilt: 0° to 75°; Rotate: 0° to 360°	
WDR	≥ 130 dB	130 dB	> 120 dB
Video Frame Rate	TVI: 2 MP@25fps, 2 MP@30fps, 4 MP@25fps, 4 MP@30fps, 5 MP@20fps AHD: 4 MP@25fps, 4 MP@30fps, 5 MP@20fps CVI: 4 MP@25fps, 4 MP@30fps CVBS: PAL, NTSC	TVI: 8MP@12.5fps, 8MP@15fps, 5MP@20fps, 4MP@25fps, 4MP@30fps, 1080P@25fps, 1080P@30fps AHD: 8MP@12.5fps, 8MP@15fps CVI: 8MP@12.5fps, 8MP@15fps CVBS: P/N	1920×1080@25fps
HD Video Output	Switchable TVI/AHD/CVI/CVBS	TVI/AHD/CVI/CVBS	1 Analog HD output
CVBS Output			
Camera ID			





FIXED BULLET CAMERA



VARI-FOCAL BULLET CAMERA



Short Description	2 MP Balun Camera	HD1080P IR Bullet Camera	2 MP EXIR Bullet Camera	5 MP Bullet Camera	5 MP Bullet Camera
Model	DS-2CE16D0T-I2FB	DS-2CE16D0T-IRF	DS-2CE16D0T-IT3F	DS-2CE16H0T-(A)IT3ZF	DS-2CE16H0T-IT3F
Image Sensor	2 MP CMOS	2MP CMOS Image Sensor	2MP CMOS Image Sensor	5 MP CMOS image sensor	5 MP CMOS image sensor
Lens	2.8 mm, 3.6 mm, 6 mm fixed lens	2.8mm	3.6mm	2.7 mm to 13.5 mm motorized vari-focal lens	2.8 mm
Day & Night	IR cut filter	ICR	ICR	IR cut filter	ICR
Operating Conditions	-40 °C to 60 °C (-40 °F to 140 °F), humidity: 90% or less (non-condensation)	-40 °C – 60 °C (-40 °F – 140 °F), Humidity 90% or less (non-condensing)	-40 °C to 60 °C (-40 °F to 140 °F), humidity: 90% or less (non-condensation)	-40 °C – 60 °C (-40 °F – 140 °F), Humidity 90% or less (non-condensing)	-40 °C – 60 °C (-40 °F – 140 °F), Humidity 90% or less (non-condensing)
Power Supply	12 VDC ± 25%	12 VDC±15%	12 V DC±15%	12 VDC ±15%, 24 VAC ±15%	12 V DC ±25%
Power Consumption	Max. 2.5 W	Max. 4W	Max. 4 W	Max. 8.9 W	Max. 4.3 W
Protection Level	IP66	IP66	IP66	IP67	IP67
IR Range	20 m	Up to 20m	Up to 40 m	Up to 40 m	Up to 40 m
Dimensions	Φ 70 mm × 153.6 mm × 60.4 mm (Φ 2.76" × 6.05" × 2.38")	Φ70×149.5mm (Φ2.76"×5.89")	86.7 mm × 81.6 mm × 226 mm (3.4" × 3.2" × 8.9")	84.5 mm × 92 mm × 255.1 mm (3.33" × 3.62" × 10")	86.7 mm × 81.6 mm × 226 mm (3.41" × 3.23" × 8.67")
Weight	Approx. 310 g (0.68 lb.)	400g	430 g (0.95 lb.)	Approx. 705 g (1.55 lb.)	Approx. 680 g (1.5 lb.)
Appearance		Bullet	Bullet	Bullet	Bullet
Effective Pixels	1920 (H) × 1080 (V)	1920(H)*1080(V)	1920(H)*1080(V)	2560 (H) × 1944 (V)	2560 (H) × 1944 (V)
Min. illumination	Color: 0.01 Lux@(F1.2, AGC ON), 0 Lux with IR	0.01 Lux @ (F1.2,AGC ON),0 Lux with IR	0.01 Lux@(F1.2,AGC ON),0 Lux with IR	Color: 0.01 Lux @ (F1.2, AGC ON), 0 Lux with IR	0.01 Lux @ (F1.2, AGC ON), 0 Lux with IR
Angle Adjustment	Pan: 0° to 360°, Tilt: 0° to 180°, Rotate: 0° to 360°	Pan: 0 - 360°, Tilt: 0 - 180°, Rotation: 0 - 360°	Pan: 0-360°, Tilt: 0-180°, Rotation: 0-360°	Pan: 0° to 360°; Tilt: 0° to 90°; Rotate: 0° to 360°	Pan: 0-360°; Tilt: 0-180°; Rotate: 0-360°
WDR	Digital WDR			Digital WDR	Digital WDR
Video Frame Rate	PAL: 1080p@25fps NTSC: 1080p@30fps	1080p@25fps	1080p@25fps	PAL: 5 MP@20fps, 4 MP@25fps, 1080p@25fps NTSC: 5 MP@20fps, 4 MP@30fps, 1080p@30fps	5 MP@20fps, 4 MP@25fps, 1080p@25fps
HD Video Output	Switchable TVI/AHD/CVI/CVBS	Switchable TVI/AHD/CVI/CVBS	Switchable TVI/AHD/CVI/CVBS	Switchable TVI/AHD/CVI/CVBS	Switchable TVI/AHD/CVI/CVBS
CVBS Output					
Camera ID					

	VARI-FOCAL BULLET CAMERA			FIXED TURRET CAMERA	
					
Short Description	5 MP Bullet Camera	Turbo HD 5MP PoC Turret Camera	5 MP Bullet Camera	2 MP EXIR Bullet Camera	2 MP Balun Camera
Model	DS-2CE16H0T-ITSF	DS-2CE16H0T-ITE	DS-2CE16H0T-ITF	DS-2CE19D0T-IT3ZF	DS-2CE56D0T-I2FB
Image Sensor	5 MP CMOS image sensor	5 MP CMOS image sensor	5 MP CMOS image sensor	2.0 megapixel progressive scan CMOS	2 MP CMOS
Lens	3.6 mm, 6 mm, 8 mm, 12 mm fixed lens	2.8 mm, fixed lens	2.8 mm	2.7 mm to 13.5 mm	2.8 mm, 3.6 mm, 6 mm fixed lens
Day & Night	IR cut filter	IR cut filter	ICR	IR cut filter	IR cut filter
Operating Conditions	-40 °C to 60 °C (-40 °F to 140 °F), humidity: 90% or less (non-condensation)	-40 °C to 60 °C (-40 °F to 140 °F), humidity: 90% or less (non-condensation)	-40 °C – 60 °C (-40 °F – 140 °F), Humidity 90% or less (non-condensing)	-40 °C to 60 °C (-40 °F to 140 °F), Humidity: 90% or less (non-condensation)	-40 °C to 60 °C (-40 °F to 140 °F), humidity: 90% or less (non-condensation)
Power Supply	12 VDC ±25%	12 VDC ±25%, PoC.af	12 V DC ±25%	12 VDC ±25%	12 VDC ± 25%
Power Consumption	Max. 5.2 W	Max. 5.1 W	Max. 4.3 W	Max. 7.7 W	Max. 2.5 W
Protection Level	IP67	IP67	IP67	IP67	IP66
IR Range	Up to 80 m	Up to 20 m	Up to 20 m	Up to 70 m	20 m
Dimensions	86.7 mm × 81.6 mm × 226 mm (3.41" × 3.23" × 8.67")	86.7 mm × 81.6 mm × 226 mm (3.41" × 3.23" × 8.67")	58 mm × 61 mm × 163 mm (2.28" × 2.40" × 6.42")	84.5 mm × 92 mm × 255.1 mm (3.33" × 3.62" × 10")	Φ 85.8 mm × 69.7 mm (Φ 3.38" × 2.84")
Weight	Approx. 680 g (1.5 lb.)	Approx. 605 g (1.33 lb.)	Approx. 350 g (0.77 lb.)	Approx. 648 g (1.43 lb.)	Approx. 183 g (0.40 lb.)
Appearance			Bullet	Bullet	
Effective Pixels	2560 (H) × 1944 (V)	2560 (H) × 1944 (V)	2560 (H) × 1944 (V)	1920 (H) × 1080 (V)	1920 (H) × 1080 (V)
Min. illumination	Color: 0.01 Lux @ (F1.2, AGC ON), 0 Lux with IR	Color: 0.01 Lux@(F1.2, AGC ON), 0 Lux with IR	0.01 Lux @ (F1.2, AGC ON), 0 Lux with IR	0.005 Lux@(F1.2, AGC ON), 0 Lux with IR	Color: 0.01 Lux@(F1.2, AGC ON), 0 Lux with IR
Angle Adjustment	Pan: 0° to 360°; Tilt: 0° to 180°; Rotate: 0° to 360°	Pan: 0° to 360°, Tilt: 0° to 180°, Rotate: 0° to 360°	Pan: 0-360°; Tilt: 0-180°; Rotate: 0-360°	Pan: 0° to 360°, Tilt: 0° to 90°, Rotation: 0° to 360°	Pan: 0° to 360°; Tilt: 0° to 75°; Rotate: 0° to 360°
WDR		Digital WDR	Digital WDR		Digital WDR
Video Frame Rate	PAL: 5 MP@20fps, 4 MP@25fps, 1080p@25fps NTSC: 5 MP@20fps, 4 MP@30fps, 1080p@30fps	TVI: 5MP@20fps, 4MP@30fps, 4MP@25fps, 1080p@30fps, 1080p@25fps CVI: 4MP@30fps, 4MP@25fps AHD: 5MP@20fps, 4MP@30fps, 4MP@25fps CVBS: PAL/NTSC	5 MP@20fps, 4 MP@25fps, 1080p@25fps	PAL: 1080p@25fps, NTSC: 1080p@30fps	PAL: 1080p@25fps NTSC: 1080p@30fps
HD Video Output	Switchable TVI/AHD/CVI/CVBS	1 HD analog output	Switchable TVI/AHD/CVI/CVBS		Switchable TVI/AHD/CVI/CVBS
CVBS Output					
Camera ID					

	FIXED DOME CAMERA		FIXED TURRET CAMERA		VARI-FOCAL TURRET CAMERA
					
Short Description	HD1080p IR Turret Camera	2 MP IR Turret Camera	2 MP Indoor IR Dome Camera	HD 1080p EXIR Turret Camera	5 MP Turret Camera
Model	DS-2CE56D0T-IRF	DS-2CE56D0T-IRMF	DS-2CE56D0T-IRMMF	DS-2CE56D0T-IT3F	DS-2CE56H0T-IT3ZF
Image Sensor	2MP CMOS Image sensor	2MP CMOS Image Sensor	2MP CMOS Image Sensor	2MP CMOS Image Sensor	5 MP CMOS image sensor
Lens	3.6 mm	2.8mm	2.8 mm	3.6 mm	2.7- 13.5 mm
Day & Night	ICR	ICR	ICR	ICR	ICR
Operating Conditions	-40 °C to 60 °C (-40 °F to 140 °F), Humidity: 90% or less (non-condensation)	-40 °C to 60 °C (-40 °F to 140 °F), Humidity: 90% or less (non-condensation)	-40 °C to 60 °C (-40 °F to 140 °F), Humidity: 90% or less (non-condensation)	-40 °C – 60 °C (-40 °F – 140 °F), Humidity 90% or less (non-condensing)	-40 °C to 60 °C (-40 °F to 140 °F), humidity: 90% or less (non-condensation)
Power Supply	12 V DC±15%	12 VDC±15%	12 VDC±15%	12 VDC±15%	12 VDC ±25%
Power Consumption	Max. 4 W	Max. 4W	Max. 4W	Max. 4W	Max. 6.3 W
Protection Level	IP66	IP66		IP66	IP67
IR Range	Up to 20 m	Up to 20m	Up to 20m	Up to 40m	Up to 40 m
Dimensions	Φ 89.9 × 70.1 mm (3.54" × 2.76")	89.47 × 67.6 mm (3.52" × 2.7")	Φ 98 × 65.4 mm (Φ 3.86" × 2.57")	Φ 110 mm × 93.2 mm (4.33" × 3.67")	123.86 mm × 134.3 mm × 110.11 mm (4.88" × 5.29" × 4.38")
Weight	280 g (0.62 lb.)	340 g (0.75 lb.)	240 g (0.53 lb.)	350 g (0.77 lb.)	Approx. 580 g (1.28 lb.)
Appearance	Turret	Turret	Indoor Dome	Turret	Turret
Effective Pixels	1920(H)*1080(V)	1920(H)*1080(V)	1920(H)*1080(V)	1920(H)*1080(V)	2560 (H) × 1944 (V)
Min. illumination	0.01 Lux@(F1.2,AGC ON),0 Lux with IR	0.01 Lux @ (F1.2,AGC ON),0 Lux with IR	0.01 Lux @ (F1.2,AGC ON),0 Lux with IR	0.01 Lux @ (F1.2,AGC ON),0 Lux with IR	Color: 0.01 Lux @ (F1.2, AGC ON), 0 Lux with IR
Angle Adjustment	Pan: 0 - 360°, Tilt: 0 - 75°, Rotation: 0 - 360°	Pan: 0 - 360°, Tilt: 0 - 75°, Rotation: 0 - 360°	Pan: 0-350°, Tilt: 0-70°, Rotation: 0-350°	Pan: 0 - 360°, Tilt: 0 - 75°, Rotation: 0 - 360°	Pan: 0-360°; Tilt: 0-75°; Rotate: 0-360°
WDR					
Video Frame Rate	1080p@25fps	1080p@25fps	1080p@25fps	1080p@25fps	5 MP@20fps, 4 MP@25fps, 1080p@25fps
HD Video Output	Switchable TVI/AHD/CVI/CVBS	Switchable TVI/AHD/CVI/CVBS	Switchable TVI/AHD/CVI/CVBS	Switchable TVI/AHD/CVI/CVBS	Switchable TVI/AHD/CVI/CVBS
CVBS Output					
Camera ID					

FIXED TURRET CAMERA



VARI-FOCAL DOME CAMERA



FIXED DOME CAMERA



VARI-FOCAL DOME CAMERA



Short Description	5 MP Turret Camera	5 MP Turret Camera	5 MP Dome Camera	5 MP Dome Camera	2 MP EXIR Dome Camera
Model	DS-2CE56H0T-ITME	DS-2CE56H0T-ITMF	DS-2CE56H0T-VPIT3ZF	DS-2CE56H0T-VPITF	DS-2CE5AD0T-IT3ZF
Image Sensor	5 MP CMOS image sensor	5 MP CMOS image sensor	5 MP CMOS	5 MP CMOS image sensor	2.0 megapixel progressive scan CMOS
Lens	2.8 mm, 3.6 mm, 6 mm fixed Lens	2.8 mm	2.7 mm to 13.5 mm motorized varifocal lens	2.8 mm, 3.6 mm, 6 mm fixed lens	2.7 mm to 13.5 mm
Day & Night	IR cut filter	ICR	IR cut filter	IR cut filter	IR cut filter
Operating Conditions	-40 °C – 60 °C (-40 °F – 140 °F), Humidity 90% or less (non-condensing)	-40 °C – 60 °C (-40 °F – 140 °F), Humidity 90% or less (non-condensing)	-40 °C to 60 °C (-40 °F to 140 °F), humidity: 90% or less (non-condensation)	-40 °C to 60 °C (-40 °F to 140 °F), humidity: 90% or less (non-condensation)	-40 °C to 60 °C (-40 °F to 140 °F), Humidity: 90% or less (non-condensation)
Power Supply	12 VDC ±25%, PoC.af	12 V DC ±25%	12 VDC ±15%, 24 VAC ±15%	12 VDC ±25%	12 VDC ±25%
Power Consumption	Max. 4.3 W	Max. 4.3 W	Max. 4.4 W	Max. 4.3 W	Max. 7.7 W
Protection Level	IP67	IP67	IP67, IK10	IP67, IK10	IP67, IK10
IR Range	Up to 20 m	Up to 20 m	40 m		Up to 70 m
Dimensions	91 mm × 82.6 mm × 68.3 mm (3.58" × 3.25" × 2.69")	91 mm × 82.6 mm × 68.3 mm (3.58" × 3.25" × 2.69")	Φ 145.2 mm × 124.1 mm (Φ 7.1" × 4.9")	Ø 111 mm × 82.4 mm (Ø 4.4" × 3.2")	84.5 mm × 92 mm × 255.1 mm (3.33" × 3.62" × 10")
Weight	Approx. 253 g (0.56 lb.)	Approx. 350 g (0.77 lb.)	Approx. 610 g (1.34 lb.)	Approx. 350 g (0.77 lb.)	Approx. 830 g (1.83 lb.)
Appearance		Turret			
Effective Pixels	2560 (H) × 1944 (V)	2560 (H) × 1944 (V)	2560 (H) × 1944 (V)	2560 (H) × 1944 (V)	1920 (H) × 1080 (V)
Min. illumination	Color: 0.01 Lux @ (F1.2, AGC ON), 0 Lux with IR	0.01 Lux @ (F1.2, AGC ON), 0 Lux with IR	Color: 0.01 Lux@(F1.2, AGC ON), 0 Lux with IR	Color: 0.01 Lux @ (F1.2, AGC ON), 0 Lux with IR	0.005 Lux@(F1.2, AGC ON), 0 Lux with IR
Angle Adjustment	Pan: 0° to 360°; Tilt: 0° to 75°; Rotate: 0° to 360°	Pan: 0-360°; Tilt: 0-75°; Rotate: 0-360°	Pan: 0° to 355°; Tilt: 0° to 75°; Rotate: 0° to 355°	Pan: 0° to 355°; Tilt: 0° to 75°; Rotate: 0° to 355°	Pan: 0° to 340°, Tilt: 0° to 75°, Rotation: 0° to 355°
WDR		Digital WDR	Digital WDR	Digital WDR	
Video Frame Rate	PAL: 5 MP@20fps, 4 MP@25fps, 1080p@25fps NTSC: 5 MP@20fps, 4 MP@30fps, 1080p@30fps	5 MP@20fps, 4 MP@25fps, 1080p@25fps	PAL: 5 MP@20fps, 4 MP@25fps, 1080p@25fps NTSC: 5 MP@20fps, 4 MP@30fps, 1080p@30fps	PAL: 5 MP@20fps, 4 MP@25fps, 1080p@25fps NTSC: 5 MP@20fps, 4 MP@30fps, 1080p@30fps	PAL: 1080p@25fps NTSC: 1080p@30fps
HD Video Output	1 HD analog output	Switchable TVI/AHD/CVI/CVBS	Switchable TVI/AHD/CVI/CVBS	Switchable TVI/AHD/CVI/CVBS	
CVBS Output					
Camera ID					

FIXED TURRET CAMERA



Short Description	5 MP Dome Camera	2 MP Mini Turret Camera	5 MP Audio Camera	2 MP EXIR Turret Camera
Model	DS-2CE5AH0T-(A)VPIT3ZF	DS-2CE70D0T-ITMF	DS-2CE76H0T-ITMFS	DS-2CE79D0T-IT3ZF(2.7-13.5mm)(EU)
Image Sensor	5 MP CMOS image sensor	2 MP CMOS	5 MP CMOS	2.0 megapixel progressive scan CMOS
Lens	2.7 mm to 13.5 mm motorized vari-focal lens	2.8 mm, 3.6 mm, 6 mm fixed lens	2.8 mm	2.7 mm to 13.5 mm
Day & Night	IR cut filter	IR cut filter	ICR	IR cut filter
Operating Conditions	-40 °C – 60 °C (-40 °F – 140 °F), Humidity 90% or less (non-condensing)	-40 °C to 60 °C (-40 °F to 140 °F), humidity: 90% or less (non-condensation)	-40 °C – 60 °C (-40 °F – 140 °F), Humidity 90% or less (non-condensing)	-40 °C to 60 °C (-40 °F to 140 °F), Humidity: 90% or less (non-condensation)
Power Supply	12 VDC ±15%, 24 VAC ±15%	12 VDC ±25%*You are recommended to use one power adapter to supply the power for one camera.	12 V DC ±25%	12 VDC ±25%
Power Consumption	DS-2CE5AH0T-VPIT3ZF: Max. 4.4 W DS-2CE5AH0T-AVPIT3ZF: Max. 6.0 W	Max. 3.6 W	Max. 4.3 W	Max. 7.7 W
Protection Level	IP67, IK10	IP67	IP67	IP67
IR Range	Up to 40 m	20 m	30 m	Up to 70 m
Dimensions	Ø 145 mm × 111.3 mm (Ø 5.70" × 4.37")	Φ 61.12 mm × 60 mm (Φ 2.57" × 2.56")	82.6 mm × 90 mm × 79.37 mm (3.25" × 3.54" × 3.12")	123.87 mm × 110.24 mm × 134.3 mm (4.87" × 4.34" × 5.29")
Weight	DS-2CE5AH0T-VPIT3ZF: Approx. 815 g (1.80 lb.) DS-2CE5AH0T-AVPIT3ZF: Approx. 860 g (1.90 lb.)	160 g (0.35 lb.)	Approx. 289.5 g (0.64 lb.)	Approx. 600 g (1.32 lb.)
Appearance			Turret	Turret
Effective Pixels	2560 (H) × 1944 (V)	1920 (H) × 1080 (V)	2560 (H) × 1944 (V)	1920 (H) × 1080 (V)
Min. illumination	Color: 0.01 Lux @ (F1.2, AGC ON), 0 Lux with IR	Color: 0.01 Lux@(F1.2, AGC ON), 0 Lux with IR	0.01 Lux@(F1.2, AGC ON), 0 Lux with IR	0.005 Lux@(F1.2, AGC ON), 0 Lux with IR
Angle Adjustment	Pan: 0° to 355°; Tilt: 0° to 75°; Rotate: 0° to 355°	Pan: 0° to 360°, Tilt: 0° to 80°, Rotation: 0° to 360°	Pan: 0 to 360°, Tilt: 0 to 75°, Rotation: 0 to 360°	Pan: 0° to 360°, Tilt: 0° to 90°, Rotation: 0° to 360°
WDR	Digital WDR	Digital WDR	Digital WDR	
Video Frame Rate	PAL: 5 MP@20fps, 4 MP@25fps, 1080p@25fps NTSC: 5 MP@20fps, 4 MP@30fps, 1080p@30fps	TVI: 1080P@25fps, 1080P@30fps AHD: 1080P@25fps, 1080P@30fps CVI: 1080P@25fps, 1080P@30fps CVBS: P/N	TVI: 5MP@20fps, 4MP@30fps, 4MP@25fps, 1080P@30fps, 1080P@25fps CVI: 4MP@30fps, 4MP@25fps AHD: 5MP@20fps, 4MP@30fps, 4MP@25fps CVBS: PAL/NTSC	PAL: 1080p@25fpsNTSC: 1080p@30fps
HD Video Output	Switchable TVI/AHD/CVI/CVBS	Switchable TVI/AHD/CVI/CVBS		
CVBS Output				
Camera ID				

VARI-FOCAL TURRET CAMERA

IP PTZ CAMERAS

Hikvision PTZ Cameras provide a wide array of benefits giving customers maximum tracking and more detail. Features like autotracking, up to 50x optical zoom, an IR range of up to 200 metres, make this series a valuable addition to any solution.

NAME CODING RULE

DS-2	D	F	8	2	30	(T)	(N)	(I)	(H)	-A	(3)	(C)	(L)	(V)	(/3G)
DS-: General Products iDS-: Intelligent products	A: analog/digital D: network	F: F series E: E series	2: 2.5 inch 4: 4 inch 5: 5 inch 6: 6 inch 7: 7 inch 8: 8 inch XA: X inch enhanced	0: 700TVL or WD1 1: 1.3MP 2: 2MP 3: 3MP 4: 4MP 5: 5MP 6: 6MP 8: 8MP	03: 3x optical 04: 4x optical 12: 12x optical 18: 18x optical 20: 20x optical 23: 23x optical 25: 25x optical 30: 30x optical 32: 32x optical 36: 36x optical 50: 50x optical	local video output Default: BNC output or none T: HD TVI S: HD-SDI	Video standard Default: PAL or High definition N: NTSC	IR light Default: without IR I: with IR light I3: 300m laser IR I5: 500m laser IR	X: H3 series H: H1 series (Darkfighter X) V: R4 series W: R7 Series	Power supply A: AC24V D: DC12V E: PoE/PoE+/Hi-POE	Installation type Default: outdoor mounting 3: indoor mounting (both ceiling or in-ceiling) 4: support multiple installation types	Interface Default: RJ45 network interface or BNC standard definition interface C: Coaxial transmission F: fiber interface S: SDI interface	Extra function Default: normal L: start in low temperature W: Wiper	Protection Default: normal V: Vandal-proof X: Anti-explosion Y: Anti-corrosion	Other /WIFI /3G /4G

IR INDOOR PTZ



OUTDOOR PTZ



IR OUTDOOR PTZ



Short Description	2MP 15× Network IR PTZ Camera	2 MP 25× Network IR PTZ Camera	2MP 25× Network IR Speed Dome	2MP 32× Network Speed Dome	4 MP 25 × Network IR Speed Dome
Model	DS-2DE4A215IW-DE(C)	DS-2DE4A225IW-DE(B)	DS-2DE5225IW-AE(C)	DS-2DE5232W-AE	DS-2DE5425IW-AE(C)
Working Temperature	Temperature: -30°C to 65°C (-22°F to 149°F)	Temperature: -30°C to 65°C (-22°F to 149°F)	-30°C to 65°C (-22°F to 149°F)	Temperature: -30°C to 65°C (-22°F to 149°F)	-30°C to 65°C (-22°F to 149°F)
Protection Level	IP66 Standard; TVS 4000V Lightning Protection, Surge Protection and Voltage Transient Protection	IP66 Standard; TVS 4000V Lightning Protection, Surge Protection and Voltage Transient Protection	IP66 Standard, 4000V Lightning Protection, Surge Protection and Voltage Transient Protection	IP66 Standard, TVS 4000V Lightning Protection, Surge Protection and Voltage Transient Protection	IP66 Standard, 4000V Lightning Protection, Surge Protection and Voltage Transient Protection
Image Sensor	1/2.8" progressive scan CMOS	1/2.8" progressive scan CMOS	1/2.8" progressive scan CMOS	1/2.8" Progressive scan CMOS	1/2.8" progressive scan CMOS
Min. Illumination	Color: 0.005 Lux @(F1.6, AGC ON)B/W: 0.001 Lux @(F1.6, AGC ON)0 Lux with IR	Color: 0.005 Lux @(F1.6, AGC ON) B/W: 0.001 Lux @(F1.6, AGC ON) 0 Lux with IR	Color: 0.005 Lux @(F1.6, AGC ON)B/W: 0.001Lux @(F1.6, AGC ON)0 Lux with IR	Color: 0.005 Lux @(F1.6, AGC ON)B/W: 0.001Lux @(F1.6, AGC ON)	Color: 0.005 Lux @(F1.6, AGC ON)B/W: 0.001Lux @(F1.6, AGC ON)0 Lux with IR
Max. Image Resolution				1920×1080	
Focal Length	5 mm to 75 mm	4.8 mm to 120 mm	4.8 mm to 120 mm	4.8 mm to 153 mm	4.8 mm to 120 mm
Optical Zoom	15×	15×	25×	32×	25×
Angle of View	Horizontal field of view: 53.8° to 4.0° [wide-tele]Vertical field of view: 31.9° to 2.3° [wide-tele]Diagonal field of view: 60.4° to 4.6° [wide-tele]	Horizontal field of view: 57.6° to 2.5° [wide-tele]Vertical field of view: 34.4° to 1.4° [wide-tele] Diagonal field of view: 64.5° to 2.9° [wide-tele]	Horizontal field of view: 57.6° to 2.5° [Wide-Tele]Vertical field of view: 34.4° to 1.4° [Wide-Tele]Diagonal field of view: 64.5° to 2.9° [Wide-Tele]	Horizontal field of view: 55.6° to 2.04° [Wide-Tele]	Horizontal field of view: 55° to 2.4° [Wide-Tele]Vertical field of view: 33° to 1.4° [Wide-Tele]Diagonal field of view: 61.5 to 2.8° [Wide-Tele]
Aperture Range	F1.6 to F3.5	F1.6 to F3.8	F1.6 to F3.5	F1.2 to F4.4	F1.6 to F3.5
Range	Pan:360°,Tilt:From -5° to 90°	Pan:360°,Tilt:From -5° to 90°	Movement Range (Pan) 360° endlessMovement Range (Tilt) From -15° to 90° [auto-flip]	Pan:360° endless; Tilt: From -5° to 90°	Movement Range (Pan) 360° endlessMovement Range (Tilt) From -15° to 90° [auto-flip]
Speed	Pan:Configurable, from 0.1°/s to 100°/s, Preset Speed: 100°/sTilt: Configurable, from 0.1°/s to 100°/s, Preset Speed: 100°/s	Pan:Configurable, from 0.1°/s to 300°/s, Preset Speed: 350°/s Tilt: Configurable, from 0.1°/s to 160°/s, Preset Speed: 200°/s	Pan Speed Configurable, from 0.1°/s to 120°/sPreset speed: 120°/sTilt Speed Configurable, from 0.1°/s to 80°/sPreset Speed: 80°/s	Pan Manual Speed: Configurable, from 0.1°/s to 250°/s, Preset Speed: 300°/sTilt Manual Speed: Configurable, from 0.1°/s to 150°/s, Preset Speed: 200°/s	Pan Speed Configurable, from 0.1°/s to 80°/s, Preset speed: 80°/sTilt Speed Configurable, from 0.1°/s to 80°/sPreset Speed: 80°/s
IR Distance	50m	50m		-	
Alarm Input	-	2		2	
Alarm Output	-	2		1	
Mini SD Memory Card	Built-in memory card slot, support Micro SD/SDHC/SDXC, up to 256 GB; NAS (NFS, SMB/ CIFS), ANR	Built-in memory card slot, support Micro SD/SDHC/SDXC, up to 256 GB; NAS (NFS, SMB/ CIFS), ANR	Built-in memory card slot, support Micro SD/SDHC/SDXC, up to 256 GB; NAS (NFS, SMB/ CIFS), ANR	Built-in memory card slot, support Micro SD/SDHC/SDXC, up to 256 GB; NAS (NFS, SMB/ CIFS), ANR	Built-in memory card slot, support Micro SD/SDHC/SDXC, up to 256 GB; NAS (NFS, SMB/ CIFS), ANR
Power	12 VDC and PoE+ (802.3at, class4)Max.: 18 W (IR light 5 W Max.)	12 VDC & PoE+ (802.3at, class4), Max.:18 W (IR Max.5 W)	24 VAC and Hi-PoEMax.: 30 W, including max. 10W for IR	24 VAC and PoE+ (802.3at, class4)Max.: 22W	12 VDC, 2.0 A and PoE (802.3 at), 42.5 to 57 VDC, 0.6 A, class4Max.: 18 W, including max. 7W for IR
Dimensions	Φ 169 mm × 161 mm (Φ 6.65" × 6.34")	Φ 169 mm × 161 mm (Φ 6.65" × 6.34")	Φ 208 mm × 345 mm (Φ 8.19" × 13.58")	Φ 220 mm × 305 mm (Φ 8.66" × 12.01") [Outdoor]Φ 183.4 mm × 243 mm (Φ 7.22" × 9.57") [Indoor]Φ 245 mm × 236 mm (Φ 9.65" × 9.29") [In-ceiling]	Φ 164.5 mm × 290 mm (Φ 6.48" × 11.42")
Weight (approx.)	Approx. 2.45 kg (5.40 lb)	Approx. 2.45 kg (5.40 lb)	Approx. 3.3 kg (7.28 lb)	approx. 3 kg	Approx. 2 kg (4.41 lb)



Short Description	2MP 32x Network IR Speed Dome
Model	DS-2DE7232IW-AE(B)
Working Temperature	-30°C to 65°C (-22°F to 149°F)
Protection Level	IP66 Standard, TVS 4000V Lightning Protection, Surge Protection and Voltage Transient Protection
Image Sensor	1/2.8" progressive scan CMOS
Min. Illumination	Color: 0.005 Lux @(F1.6, AGC ON) B/W: 0.001Lux @(F1.6, AGC ON) 0 Lux with IR
Max. Image Resolution	
Focal Length	4.8 mm to 153 mm
Optical Zoom	32x
Angle of View	Horizontal field of view: 55.6° to 2.04° (Wide-Tele) Vertical field of view: 32.4° to 1.14° (Wide-Tele) Diagonal field of view: 63° to 2.34° (Wide-Tele)
Aperture Range	F1.2 to F4.4
Range	Pan:360° endless; Tilt From -15° to 90° (Auto-flip)
Speed	Pan:Configurable, from 0.1°/s to 160°/s, Preset Speed: 240°/s Tilt Speed:Configurable, from 0.1°/s to 120°/s, Preset Speed: 200°/s
IR Distance	150m
Alarm Input	
Alarm Output	
Mini SD Memory Card	Built-in memory card slot, support Micro SD/SDHC/SDXC, up to 256 GB; NAS (NFS, SMB/ CIFS), ANR
Power	24 VAC and Hi-PoE Max.: 40 W (Max. 14 W for IR)
Dimensions	Φ 220 mm × 353.4 mm (Φ 8.66" × 13.91")
Weight (approx.)	Approx. 4.5 kg (9.92 lb)

IR INDOOR PTZ



Short Description	2 MP 4 × IR PTZ Network Camera	4MP 4x IR Network PTZ Camera	4 MP 4 × IR PTZ Network Camera	2MP Network Mini PTZ Dome Camera	2 MP Network Mini PTZ Dome Camera
Model	DS-2DE2A204W-DE3(C)	DS-2DE2A404IW-DE3	DS-2DE2A404IW-DE3(2.8-12mm)(C)	DS-2DE3204W-DE	DS-2DE3204W-DE(B)
Working Temperature	Temperature: -20°C to 60°C (-4°F to 140°F), humidity: ≤ 90%	-20°C to 60°C (-4°F to 140°F)	Temperature: -20°C to 60°C (-4°F to 140°F), humidity: ≤ 90%	-30°C ~ 65°C (-22°F ~ 149°F)	Temperature: -30°C to 65°C (-22°F to 149°F), humidity: ≤ 90%
Protection Level	IP66 standard, IK 10, surge protection, ±2kV Line to Gnd, ±1kV Line to Line, IEC61000-4-5	IP66 Standard, IK10, TVS 4000V Lightning Protection, Surge Protection and Voltage Transient Protection	IP66 standard, IK 10, surge protection, ±2kV Line to Gnd, ±1kV Line to Line, IEC61000-4-5	IP66, IK10, TVS 4,000V lightning protection, surge protection and voltage transient protection	IP66, IK10, 4000V Lightning Protection, Surge Protection, Voltage Transient Protection
Image Sensor	1/3" progressive scan CMOS	1/3" progressive scan CMOS	1/3" progressive scan CMOS	1/2.8" Progressive scan CMOS	1/2.8" progressive scan CMOS
Min. Illumination	Color: 0.005 Lux @(F1.6, AGC ON) B/W:0.001 Lux @(F1.6, AGC ON) 0 Lux with IR	Color: 0.005 Lux @(F1.6, AGC ON) B/W: 0.001 Lux @(F1.6, AGC ON) 0 Lux with IR	Color: 0.005 Lux @(F1.6, AGC ON)B/W: 0.001Lux @(F1.6, AGC ON)0 Lux with IR	F1.6, AGC On : Color : 0.05 lux, B/W : 0.01 lux	Color: 0.05 Lux @(F1.5, AGC ON) B/W:0.01 Lux @(F1.5, AGC ON)
Max. Image Resolution					
Focal Length	2.8 mm to 12 mm	2.8 mm to 12 mm	2.8 mm to 12 mm	2.8-12mm	2.8 mm to 12 mm
Optical Zoom	4 ×	4x	4 ×	4x	4 ×
Angle of View	Horizontal field of view: 100.5° to 32.6° (Wide-Tele) Vertical field of view: 52.8° to 18.3° (Wide-Tele) Diagonal field of view: 120.2° to 37.5° (Wide-Tele)	Horizontal field of view: 100° to 33° (Wide-Tele) Vertical field of view: 53° to 18° (Wide-Tele) Diagonal field of view: 119° to 37.5° (Wide-Tele)	Horizontal field of view: 96.7° to 31.6° (Wide-Tele) Vertical field of view: 51.1° to 17.7° (Wide-Tele) Diagonal field of view: 115.1° to 36.3° (Wide-Tele)	105-33.5 degree (Wide-Tele)	Horizontal field of view: 100.5° to 32.6° (wide-tele)
Aperture Range	F1.6 to F2.7	F1.6 to F2.7	F1.6 to F2.7	F1.6 -F2.7	F1.5 to F2.7
Range	Movement Range (Pan) 0° to 355°Movement Range (Tilt) 0° to 90°	Pan:0° to 330°;Tilt:From 0° to 90°	Movement Range (Pan) 0° to 355°Movement Range (Tilt) 0° to 90°	Pan: 0-350°; Tilt: 0°-90°	Movement Range (Pan) 0° to 350° Movement Range (Tilt) 0° to 90°
Speed	Pan Speed Configurable, from 0.1°/s to 100°/s. Preset speed: 100°/sTilt Speed Configurable, from 0.1°/s to 100°/s. Preset speed: 100°/s	Pan:Configurable, from 0.1°/s to 100°/s, Preset speed: 100°/s;Tilt:Configurable, from 0.1°/s to 100°/s Preset Speed: 100°/s	Pan Speed Configurable, from 0.1°/s to 100°/s. Preset speed: 100°/sTilt Speed Configurable, from 0.1°/s to 100°/s. Preset speed: 100°/s	Pan Manual Speed: 0.1°-60°/s, Pan Preset Speed: 60°/s Tilt Manual Speed: 0.1°-50°/s, Tilt Preset Speed: 50°/s	Pan Speed Configurable, from 0.1°/s to 60°/s. Preset Speed: 60°/s , Tilt Speed Configurable, from 0.1°/s to 50°/s. Preset Speed: 50°/s
IR Distance					
Alarm Input		-		1	1
Alarm Output		-		1	1
Mini SD Memory Card	Built-in memory card slot, support microSD/SDHC/SDXC, up to 256 GB; NAS (NFS, SMB/ CIFS), ANR	Built-in memory card slot, support Micro SD/SDHC/SDXC, up to 256 GB; NAS (NFS, SMB/ CIFS), ANR		Support up to 128GB Micro SD/SDHC/SDXC card. Support Edge recording	Built-in memory card slot, support Micro SD/SDHC/SDXC, up to 256 GB; NAS (NFS, SMB/ CIFS), ANR
Power	12 VDC (Max. 9.9 W, including max. 4.2 W for IR) PoE 802.3af (Max. 11.2 W, including max. 4.2 W for IR)	12 VDC & PoE Max.: 12 W (Max. 3.9 W for IR)	12 VDC, 1.5 A (Max. 9.9 W, including max. 4.2 W for IR) PoE (802.3af), 36 to 57 VDC, 0.35 A (Max. 11.2 W, including max. 4.2 W for IR)	POE (802.3af, class3) & 12 VDC, Max. 8W	2 VDC, 1.0 A, Max. 8W and PoE (802.3af), 36 to 57 VDC, 0.35 A, Class 3
Dimensions	Φ 130.7 mm × 101.7 mm (Φ 5.15" × 4.00")	Φ 130.7 mm × 101.7 mm (Φ 5.15" × 4.00")	Φ 130.7 mm × 101.7 mm (Φ 5.15" × 4.00")	Φ 140.7×107.2mm	Φ 140.7 mm × 107.2 mm (Φ 5.5" × 4.2")
Weight (approx.)	Approx. 0.53 kg (1.17 lb.)	Approx. 0.53 kg (1.17 lb)	Approx. 0.53 kg (1.17 lb.)	950g	Approx. 0.95 kg (2.1 lb.)

IR OUTDOOR PTZ



OUTDOOR PTZ



IR OUTDOOR PTZ



Short Description	2MP 15× Network IR Speed Dome	2MP 25× Network IR Speed Dome	2MP 25× Network Speed Dome	4 MP 25 × Network IR Speed Dome
Model	DS-2DE4215IW-DE(E)	DS-2DE4225IW-DE(E)	DS-2DE4225W-DE(B)	DS-2DE4425IW-DE(E)
Working Temperature	-30°C to 65°C [-22°F to 149°F]	-30°C to 65°C [-22°F to 149°F]	-30°C to 65°C [-22°F to 149°F]	-30°C to 65°C [-22°F to 149°F]
Protection Level	IP66 Standard, 4000V Lightning Protection, Surge Protection and Voltage Transient Protection	IP66 Standard, 4000V Lightning Protection, Surge Protection and Voltage Transient Protection	IP66 Standard, 4000V Lightning Protection, Surge Protection and Voltage Transient Protection	IP66 Standard, 4000V Lightning Protection, Surge Protection and Voltage Transient Protection
Image Sensor	1/2.8" progressive scan CMOS	1/2.8" progressive scan CMOS	1/2.8" progressive scan CMOS	1/2.8" progressive scan CMOS
Min. Illumination	Color: 0.005 Lux @(F1.6, AGC ON)B/W: 0.001Lux @(F1.6, AGC ON)0 Lux with IR	Color: 0.005 Lux @(F1.6, AGC ON)B/W: 0.001Lux @(F1.6, AGC ON)0 Lux with IR	Color: 0.005 Lux @(F1.6, AGC ON)B/W: 0.001Lux @(F1.6, AGC ON)0 Lux with IR	Color: 0.005 Lux @(F1.6, AGC ON)B/W: 0.001Lux @(F1.6, AGC ON)0 Lux with IR
Max. Image Resolution				
Focal Length	5 mm to 75 mm	4.8 mm to 120 mm	4.8 mm to 120 mm	4.8 mm to 120 mm
Optical Zoom	15×	25×	25×	25×
Angle of View	Horizontal field of view: 53.8° to 4° [Wide-Tele]Vertical field of view: 31.9° to 2.3° [Wide-Tele]Diagonal field of view: 60.4° to 4.6° [Wide-Tele]	Horizontal field of view: 57.6° to 2.5° [Wide-Tele]Vertical field of view: 34.4° to 1.4° [Wide-Tele]Diagonal field of view: 64.5° to 2.9° [Wide-Tele]	Horizontal field of view: 57.6° to 2.5° [Wide-Tele]Vertical field of view: 34.4° to 1.4° [Wide-Tele]Diagonal field of view: 64.5° to 2.9° [Wide-Tele]	Horizontal field of view: 55° to 2.4° [Wide-Tele]Vertical field of view: 33° to 1.4° [Wide-Tele]Diagonal field of view: 61.5 to 2.8° [Wide-Tele]
Aperture Range	F1.6 to F2.8	F1.6 to F3.5	F1.6 to F3.5	F1.6 to F3.5
Range	Movement Range (Pan) 360° endlessMovement Range (Tilt) From -15° to 90° [auto-flip]	Movement Range (Pan) 360° endlessMovement Range (Tilt) From -15° to 90° [auto-flip]	Movement Range (Pan) 360° endlessMovement Range (Tilt) From -15° to 90° [auto-flip]	Movement Range (Pan) 360° endlessMovement Range (Tilt) From -15° to 90° [auto-flip]
Speed	Pan Speed Configurable, from 0.1°/s to 80°/s, Preset speed: 80°/sTilt Speed Configurable, from 0.1°/s to 80°/sPreset Speed: 80°/s	Pan Speed Configurable, from 0.1°/s to 80°/s, Preset speed: 80°/sTilt Speed Configurable, from 0.1°/s to 80°/sPreset Speed: 80°/s	Pan Speed Configurable, from 0.1°/s to 80°/s, Preset speed: 80°/sTilt Speed Configurable, from 0.1°/s to 80°/sPreset Speed: 80°/s	Pan Speed Configurable, from 0.1°/s to 80°/s, Preset speed: 80°/sTilt Speed Configurable, from 0.1°/s to 80°/sPreset Speed: 80°/s
IR Distance				
Alarm Input			1	
Alarm Output			1	
Mini SD Memory Card	Built-in memory card slot, support Micro SD/SDHC/SDXC, up to 256 GB; NAS (NFS, SMB/ CIFS), ANR	Built-in memory card slot, support Micro SD/SDHC/SDXC, up to 256 GB; NAS (NFS, SMB/ CIFS), ANR	Built-in memory card slot, support Micro SD/SDHC/SDXC, up to 256 GB; NAS (NFS, SMB/ CIFS), ANR	Built-in memory card slot, support Micro SD/SDHC/SDXC, up to 256 GB; NAS (NFS, SMB/ CIFS), ANR
Power	12 VDC, 2.0A, PoE (802.3at), 42.5 to 57 VDC, 0.6A, Class4Max.18 W, including Max.7W for IR	12 VDC, 2.0 A and PoE (802.3at), 42.5 to 57 VDC, 0.6A, Class4Max.18 W, including max.7W for IR	12 VDC, 2.0 A and PoE (802.3 at), 42.5 to 57 VDC, 0.6 A, class4Max.: 18 W	12 VDC, 2.0 A and PoE (802.3 at), 42.5 to 57 VDC, 0.6 A, class4Max.: 18 W, including max. 7W for IR
Dimensions	Φ 164.5 mm × 290 mm (Φ 6.48" × 11.42")	Φ 164.5 mm × 290 mm (Φ 6.48" × 11.42")	Φ 180 mm × 239.5 mm (Φ 7.09" × 9.43")	Φ 164.5 mm × 290 mm (Φ 6.48" × 11.42")
Weight (approx.)	Approx. 2 kg (4.41 lb)	Approx. 2 kg (4.41 lb)	Approx. 2 kg (4.41 lb)	Approx. 2 kg (4.41 lb)

TURBO HD PTZ CAMERAS

PTZ cameras deliver an incredible image in all sorts of environment where following a target or more detail is needed. They are designed for installations that do not require the 360° high speed positioning of traditional PTZ cameras but that do need occasional pan/tilt/zoom capabilities, including presets, patrols and patterns. The series boasts IP66 and IK10 ratings, allowing the cameras to be mounted in both in- and outdoor installations.

NAME CODING RULE

DS-2	D	F	8	2	30	(T)	(N)	(I)	(H)	-A	(3)	(C)	(L)	(V)	(/3G)
DS-: General Products iDS-: Intelligent products	A: analog/digital D: network	F: F series E: E series	2: 2.5 inch 4: 4 inch 5: 5 inch 6: 6 inch 7: 7 inch 8: 8 inch XA: X inch enhanced	0: 700TVL or WD1 1: 1.3MP 2: 2MP 3: 3MP 4: 4MP 5: 5MP 6: 6MP 8: 8MP	03: 3x optical 04: 4x optical 12: 12x optical 18: 18x optical 20: 20x optical 23: 23x optical 25: 25x optical 30: 30x optical 32: 32x optical 36: 36x optical 50: 50x optical	local video output Default: BNC output or none T: HD TVI S: HD-SDI	Video standard Default: PAL or High definition N: NTSC	IR light Default: without IR I: with IR light I3: 300m laser IR I5: 500m laser IR	X: H3 series H: H1 series [Darkfighter X] V: R4 series W: R7 Series	Power supply A: AC24V D: DC12V E: PoE/PoE+/Hi-POE	Installation type Default: outdoor mounting 3: indoor mounting (both ceiling or in-ceiling) 4: support multiple installation types	Interface Default: RJ45 network interface or BNC standard definition interface C: Coaxial transmission interface F: fiber interface P: EPON interface S: SDI interface	Extra function Default: normal L: start in low temperature W: Wiper	Protection Default: normal V: Vandal-proof X: Anti-explosion Y: Anti-corrosion	Other /WIFI /3G /4G

NON-IR PTZ



Short Description	2 MP Turbo 4-Inch Speed Dome	2 MP Turbo 4-Inch Speed Dome	2 MP Turbo 5-Inch Speed Dome	2 MP Turbo 5-Inch Speed Dome
Model	DS-2AE4225T-D(D)	DS-2AE4225T-D3(D)	DS-2AE5232T-A	DS-2AE5232T-A(D)
Image Sensor	1/2.8" progressive scan CMOS	1/2.8" progressive scan CMOS	1/2.8" progressive scan CMOS	1/2.8" progressive scan CMOS
Min. Illumination	Color: 0.005 Lux @(F1.6, AGC ON) B/W: 0.001 Lux @(F1.6, AGC ON)	Color: 0.005 Lux @(F1.6, AGC ON) B/W: 0.001 Lux @(F1.6, AGC ON)	Color: 0.005 Lux @(F1.6, AGC ON) B/W: 0.001 Lux @(F1.6, AGC ON) 0 lux with IR	Color: 0.005 Lux @(F1.2, AGC ON) B/W: 0.001 Lux @(F1.2, AGC ON)
Max. Image Resolution	1920×1080	1920×1080	1920×1080	1920×1080
Focal Length	4.8 mm to 120 mm	4.8 mm to 120 mm	4.8 mm to 153 mm	4.8 mm to 153 mm
Zoom Speed	Approx. 3.6 s (optical, wide to tele)	Approx. 3.6 s (optical, wide to tele)	Approx. 3.5 s (optical, wide to tele)	Approx. 5.6 s (optical, wide to tele)
Angle of View	Horizontal field of view: 57.6° to 2.5° (wide to tele) Vertical field of view: 34.4° to 1.4° (wide to tele) Diagonal field of view: 64.5° to 2.9° (wide-tele)	Horizontal field of view: 57.6° to 2.5° (wide to tele) Vertical field of view: 34.4° to 1.4° (wide to tele) Diagonal field of view: 64.5° to 2.9° (wide to tele)	54.2° to 1.97° (wide-tele)	54.2° to 1.97° (wide-tele)
Aperture Range	F 1.6 to F 3.5	F 1.6 to F 3.5	F 1.6 to F4.6	F 1.2 to F4.4
Focus Mode	Auto/Semiauto/Manual	Auto/Semiauto/Manual	Auto/Semiauto/Manual	Auto/Semiauto/Manual
DWDR	≥ 120 dB	≥ 120 dB	DWDR	≥ 120 dB
Day & Night	IR cut filter	IR cut filter	IR cut filter	IR cut filter
Range	Pan:360° endless;Tilt:-5° to 90° (auto flip)	Pan:360° endless;Tilt:-5° to 90° (auto flip)	Pan:360° endless;Tilt:-15° to 90° (auto flip)	Pan:360° endless;Tilt:-5° to 90° (auto flip)
Speed	Pan manual speed: 0.1° to 100°/s Pan preset speed: 100°/s Tilt manual speed: 0.1° to 80°/s Tilt preset speed: 80°/s	Pan manual speed: 0.1° to 250°/s Pan preset speed: 250°/s Tilt manual speed: 0.1° to 150°/s Tilt preset speed: 150°/s	Pan manual speed: 0.1° to 120°/s Pan preset speed: 120°/s Tilt manual speed: 0.1° to 80°/s Tilt preset speed: 80°/s	Pan manual speed: 0.1° to 250°/s Pan preset speed: 250°/s Tilt manual speed: 0.1° to 150°/s Tilt preset speed: 150°/s
Number of Preset	256	256	-	256
IR Distance	NA	NA	NA	NA
Power	12 VDC Max. 16 W	12 VDC Max. 12 W	24 VAC Max. 24 W	24 VAC Max. 24 W
Working Temperature	-30° C to 65° C [-22° F to 149° F]	-30° C to 65° C [-22° F to 149° F]	Temperature:-30° C to 65° C [-22° F to 149° F]	-30° C to 65° C [-22° F to 149° F]
Protection Level	IP66 standard (outdoor dome) TVS 4,000 V lightning protection, surge protection and voltage transient protection	TVS 4,000 V lightning protection, surge protection and voltage transient protection	IP66 standard (outdoor dome)TVS 4,000 V lightning protection, surge protection and voltage transient protection	IP66 standard (outdoor dome) TVS 4,000 V lightning protection, surge protection and voltage transient protection

THERMAL SECURITY CAMERAS

Integrating technology from Hikvision's image processing and intelligent applications, our thermal products meet the rigorous demands of sophisticated security. These cameras provide superb solutions for fire protection and perimeter defence by combining the advantages thermal imaging and visible image processing.

NAME CODING RULE

DS-2	TD	XY	3	5	X	-	15	X	X2Y	X
Hikvision front-end product	Thermal Camera	X: Appearance Y: Classification 1: Turret Camera 11: Thermal-Only Turret Camera 12: Bi-spectrum Turret Camera 2: Bullet Camera 20: Box Camera 21: Thermal-Only Bullet Camera 23: Thermal-Only Long Range Bullet Camera 24: Thermal-Only Special Bullet Camera 26: Bi-spectrum Bullet Camera 28: Thermal& Optical Long Range Bullet Camera 4: Speed Dome 41: 8-inches Speed Dome 42: 5-inches Speed Dome 6: Positioning system 61: the first generation 62: the second generation 8: Stable PTZ Camera 81: the first generation	1: 160 × 120 (the resolution of output image is 320 × 240) 3: 384 × 288 6: 640 × 512	5: Vanadium Oxide Uncooled Focal Plane Detectors 25µm 6: Vanadium Oxide Uncooled Focal Plane Detectors 17µm 7: Hikmicro Vanadium Oxide Uncooled Focal Plane Detectors 17µm	D: Dual Channels T: Accurate Temperature Measurement F: Fiber	-	2: 2mm 3: 3mm 6: 6mm 7: 7mm 10:10mm 15:15mm 25: 25mm 35:35mm 50: 50mm 75: 75mm 100:100mm 150: 150mm 180: 180mm	Z: Zoom	X: Optical Lens C: 6.7-330mm, 49x E: 12.5-775mm, 62x H: 5.7-205.2mmmm, 36x 2: 2MP Y: Function L: Laser light(Stable PTZ only) I: IR light F: Optical Fog Reduction	V1: Deep learning Hardware(Bullet & Indoor Turret) V2: Deep learning Hardware(Speed Dome & PTZ) VP: HEOP Bullet

DEEP LEARNING SINGLE TURRET CAMERA

DEEP LEARNING BI-SPECTRUM TURRET CAMERA



Short Description	Deep learning Single Turret Camera	Deep learning Single Turret Camera	Deep learning Single Turret Camera	Deep learning Bi-spectrum Turret Camera	Deep learning Bi-spectrum Turret Camera
Model	DS-2TD1117-2/P	DS-2TD1117-3/P	DS-2TD1117-6/P	DS-2TD1217-2/V1	DS-2TD1217-3/V1
Max. Resolution	160*120	160*120	160*120	160*120	160*120
Pixel Interval	17 μm	17 μm	17 μm	17 μm	17 μm
Response waveband	8 μm to 14 μm	8 μm to 14 μm	8 μm to 14 μm	8 μm to 14 μm	8 μm to 14 μm
NETD	less than 40 mk (25°C), F#=1.1	less than 40 mk (25°C), F#=1.1	less than 40 mk (25°C), F#=1.1	less than 40 mk (25°C), F#=1.1	less than 40 mk (25°C), F#=1.1
Thermal Module Lens(Focal Length)	2mm	3mm	6mm	2mm	3mm
Optical Module Lens(Focal Length)				2.1mm	4mm
Bi-Spectrum image fusion				Fusion view of thermal view and overlaid details of the optical channel	Fusion view of thermal view and overlaid details of the optical channel
Picture in Picture				Combins details of thermal and optical image PIP, overlay thermal image on optical images	Combins details of thermal and optical image PIP, overlay thermal image on optical images
VCA(Video content anylasis)	4 VCA rule types (Line Crossing, Intrusion, Region Entrance, and Region Exiting), up to 8VCA rules.	4 VCA rule types (Line Crossing, Intrusion, Region Entrance, and Region Exiting), up to 8VCA rules.	4 VCA rule types (Line Crossing, Intrusion, Region Entrance, and Region Exiting), up to 8VCA rules.	4 VCA rule types (Line Crossing, Intrusion, Region Entrance, and Region Exiting), up to 8VCA rules.	4 VCA rule types (Line Crossing, Intrusion, Region Entrance, and Region Exiting), up to 8VCA rules.
Temperature Measurement	3 temperature measurement rule types, 21 rules (10 points, 10 areas, and 1 line).	3 temperature measurement rule types, 21 rules (10 points, 10 areas, and 1 line).	3 temperature measurement rule types, 21 rules (10 points, 10 areas, and 1 line).	3 temperature measurement rule types, 21 rules (10 points, 10 areas, and 1 line).	3 temperature measurement rule types, 21 rules (10 points, 10 areas, and 1 line).
Temperature Range	-20 °C to +150 °C [-4 °F to +302°F]	-20 °C to +150 °C [-4 °F to +302°F]	-20 °C to +150 °C [-4 °F to +302°F]	-20 °C to +150 °C [-4 °F to +302°F]	-20 °C to +150 °C [-4 °F to +302°F]
Temperature accuracy	± 8 °C (± 14.4 °F)	± 8 °C (± 14.4 °F)	± 8 °C (± 14.4 °F)	± 8 °C (± 14.4 °F)	± 8 °C (± 14.4 °F)
Fire Detection	Dynamic fire point detection, up to 10 fire points detectable.	Dynamic fire point detection, up to 10 fire points detectable.	Dynamic fire point detection, up to 10 fire points detectable.	Dynamic fire point detection, up to 10 fire points detectable.	Dynamic fire point detection, up to 10 fire points detectable.
Image Sensor	Vanadium Oxide Uncooled Focal Plane Arrays	Vanadium Oxide Uncooled Focal Plane Arrays	Vanadium Oxide Uncooled Focal Plane Arrays	Vanadium Oxide Uncooled Focal Plane Arrays	Vanadium Oxide Uncooled Focal Plane Arrays
Field of View	[90° × 66.4°]	[50° × 37.2°]	[25° × 18.7°]	[90.00° × 66.40°] (H × V)	[50.00° × 37.20°] (H × V)
MRAD	9.44 mrad	5.48 mrad	2.74 mrad	9.44mrad	5.48mrad
Min.Focusing distance	0.1 m	0.2 m	0.6 m	0.1m	0.2 m
Aperture	F1.1	F1.1	F1.1	F1.1	F1.1

Short Description

Deep learning Bi-spectrum Turret Camera

Model	DS-2TD1217-6/V1
Max. Resolution	160*120
Pixel Interval	17 μm
Response waveband	8 μm to 14 μm
NETD	less than 40 mk (25°C), F#=1.1
Thermal Module Lens(Focal Length)	6mm
Optical Module Lens(Focal Length)	6 mm
Bi-Spectrum image fusion	Fusion view of thermal view and overlaid details of the optical channel
Picture in Picture	Combins details of thermal and optical image PIP, overlay thermal image on optical images
VCA(Video content anylasis)	4 VCA rule types (Line Crossing, Intrusion, Region Entrance, and Region Exiting), up to 8VCA rules.
Temperature Measurement	3 temperature measurement rule types, 21 rules (10 points, 10 areas, and 1 line).
Temperature Range	-20 °C to +150 °C [-4 °F to +302°F]
Temperature accuracy	± 8 °C (± 14.4 °F)
Fire Detection	Dynamic fire point detection, up to 10 fire points detectable.
Image Sensor	Vanadium Oxide Uncooled Focal Plane Arrays
Field of View	[25.00° × 18.70°](H × V)
MRAD	2.83 mrad
Min.Focusing distance	0.6 m
Aperture	F1.1

THERMAL NETWORK BULLET CAMERA



Short Description	Thermal Network Bullet Camera	Thermal Network Bullet Camera
Model	DS-2TD2117-3/V1	DS-2TD2117-6/V1
Max. Resolution	160*120	160*120
Pixel Interval	17 μm	17 μm
Response waveband	8 μm to 14 μm	8 μm to 14 μm
NETD	less than 40 mk (25°C), F#=1.1	less than 40 mk (25°C), F#=1.1
Thermal Module Lens(Focal Length)	3mm	6mm
Optical Module Lens(Focal Length)		
Bi-Spectrum image fusion		
Picture in Picture		
VCA(Video content anylasis)	4 VCA rule types (Line Crossing, Intrusion, Region Entrance, and Region Exiting), up to 8VCA rules.	4 VCA rule types (Line Crossing, Intrusion, Region Entrance, and Region Exiting), up to 8VCA rules.
Temperature Measurement	3 temperature measurement rule types, 21 rules (10 points, 10 areas, and 1 line).	3 temperature measurement rule types, 21 rules (10 points, 10 areas, and 1 line).
Temperature Range	-20 °C to +150 °C (-4 °F to +302°F)	-20 °C to +150 °C (-4 °F to +302°F)
Temperature accuracy	± 8 °C (± 14.4 °F)	± 8 °C (± 14.4 °F)
Fire Detection	Dynamic fire point detection, up to 10 fire points detectable.	Dynamic fire point detection, up to 10 fire points detectable.
Image Sensor	Vanadium Oxide Uncooled Focal Plane Arrays	Vanadium Oxide Uncooled Focal Plane Arrays
Field of View	(50.00° × 37.20°) (H × V)	(25.00° × 18.70°) (H × V)
MRAD	5.48mrad	2.74 mrad
Min.Focusing distance	0.2m	0.6 m
Aperture	F1.1	F1.1

THERMAL & OPTICAL NETWORK BULLET CAMERA



Short Description	Thermal & Optical Network Bullet Camera	Thermal & Optical Network Bullet Camera
Model	DS-2TD2617-3/V1	DS-2TD2617-6/V1
Max. Resolution	160 × 120 (the resolution of output image is 320 × 240)	160 × 120 (the resolution of output image is 320 × 240)
Pixel Interval	1.7μm	1.7μm
Response waveband	8μm to 14μm	8μm to 14μm
NETD	less than 40 mk (@25°C,F#=1.1)	less than 40 mk (@25°C,F#=1.1)
Thermal Module Lens(Focal Length)	3.1 mm	6.2 mm
Optical Module Lens(Focal Length)	4mm	6 mm
Bi-Spectrum image fusion	Fusion view of thermal view and overlaid details of the optical channel	Fusion view of thermal view and overlaid details of the optical channel
Picture in Picture	Combins details of thermal and optical image PIP, overlay thermal image on optical images	Combins details of thermal and optical image PIP, overlay thermal image on optical images
VCA(Video content anylasis)	4 VCA rule types (Line Crossing, Intrusion, Region Entrance, and Region Exiting), up to 8 VCA rules.	4 VCA rule types (Line Crossing, Intrusion, Region Entrance, and Region Exiting), up to 8 VCA rules.
Temperature Measurement	3 temperature measurement rule types, 21 rules (10 points, 10 areas, and 1 line).	3 temperature measurement rule types, 21 rules (10 points, 10 areas, and 1 line).
Temperature Range	-20 °C to +150 °C (-4 °F to +302°F)	-20 °C to +150 °C (-4 °F to +302°F)
Temperature accuracy	± 8 °C (± 14.4 °F)	± 8 °C (± 14.4 °F)
Fire Detection	Dynamic fire point detection, up to 10 fire points detectable.	Dynamic fire point detection, up to 10 fire points detectable.
Image Sensor	Vanadium Oxide Uncooled Focal Plane Arrays	Vanadium Oxide Uncooled Focal Plane Arrays
Field of View	50° × 37.2° (H × V)	25° × 18.7° (H × V)
MRAD	5.48 mrad	2.74 mrad
Min.Focusing distance	0.2 m	0.6 m
Aperture	F1.1	F1.1

NETWORK VIDEO RECORDERS (NVRs)

Hikvision offers a wide range of NVRs, from the 4-channel to 32-channel, 1HDD to 4HDD, 4MP to 12MP in professional series. They offer IP camera monitoring, recording and playback, whatever the requirement.

NAME CODING RULE

(i)DS-	77	16	N	I	-I	2	/8P	/4S	(B)
DS-: General Products iDS-: Intelligent products	71: Value Level 76: Pro Series 77: Pro Series 96: Pro/Ultra Series	IP Channel Number 4/ 8/ 16/ 32/ 64/ 128/ 256 IP Channels	NVR Product Series N: NVR NX: NVR with Deep Learning technology	I stands for international	Product Platform	HDD Slot(s) 1: support 1 HDD 2: support 2 HDDs 4: support 4 HDDs 8: support 8 HDDs 16: support 16 HDDs 24: support 24 HDDs	Extended function and features /16P: With 16 PoE interfaces /H: With decode board /W: with WiFi module /4G: with 4G module	Intelligent Functions /4S: up to 4 channels for human detection /4F: up to 4 channels for facial recognition /4B: up to 4 channels for behavior analysis	Hardware revision (B): the second hardware revision..... X: the Xth hardware revision

	1U CHASSIS			1.5U CHASSIS
Short Description	DS-7600NI-I2/P SERIES NVR	DS-7600NI-I2/P SERIES NVR	DS-7600NXI-I/P/S AcuSense SERIES NVR	DS-7700NI-I4 SERIES NVR
Model	DS-7608NI-I2/8P	DS-7616NI-I2/16P	DS-7616NXI-I2/16P/4S	DS-7716NI-I4
IP video input	8-ch	16-ch	16-ch	16-ch
Incoming bandwidth	80 Mbps	160 Mbps	160 Mbps	160 Mbps
Outgoing bandwidth	256 Mbps	256 Mbps	256 Mbps	256 Mbps
Recording resolution	12MP/8MP/6MP/5MP/4MP/3MP/1080p/UXGA/720p/VGA/4CIF/DCIF/2CIF/CIF/QCIF	12MP/8MP/6MP/5MP/4MP/3MP/1080p/UXGA/720p/VGA/4CIF/DCIF/2CIF/CIF/QCIF	12MP/8MP/6MP/5MP/4MP/3MP/1080p/UXGA/720p/VGA/4CIF/DCIF/2CIF/CIF/QCIF	12MP/8MP/6MP/5MP/4MP/3MP/1080p/UXGA/720p/VGA/4CIF/DCIF/2CIF/CIF/QCIF
HDMI output	4K (3840 × 2160)/60Hz, 4K (3840 × 2160)/30Hz, 2K (2560 × 1440)/60Hz, 1920 × 1080p/60Hz, 1600 × 1200/60Hz, 1280 × 1024/60Hz, 1280 × 720/60Hz, 1024 × 768/60Hz	4K (3840 × 2160)/60Hz, 4K (3840 × 2160)/30Hz, 2K (2560 × 1440)/60Hz, 1920 × 1080p/60Hz, 1600 × 1200/60Hz, 1280 × 1024/60Hz, 1280 × 720/60Hz, 1024 × 768/60Hz	4K (3840 × 2160)/30Hz, 1920 × 1080/60Hz, 1600 × 1200/60Hz, 1280 × 1024/60Hz, 1280 × 720/60Hz, 1024 × 768/60Hz 4K resolution is only available for HDMI.	4K (3840 × 2160)/60Hz, 4K (3840 × 2160)/30Hz, 1920 × 1080p/60Hz, 1600 × 1200/60Hz, 1280 × 1024/60Hz, 1280 × 720/60Hz, 1024 × 768/60Hz
VGA output	1920 × 1080p/60Hz, 1280 × 1024/60Hz, 1280 × 720/60Hz, 1024 × 768/60Hz	1920 × 1080p/60Hz, 1280 × 1024/60Hz, 1280 × 720/60Hz, 1024 × 768/60Hz	1920 × 1080/60Hz, 1600 × 1200/60Hz, 1280 × 1024/60Hz, 1280 × 720/60Hz, 1024 × 768/60Hz	1920 × 1080p/60Hz, 1280 × 1024/60Hz, 1280 × 720/60Hz, 1024 × 768/60Hz
Audio output	1-ch, RCA (Linear, 1 KΩ)	1-ch, RCA (Linear, 1 KΩ)	1-ch, RCA (Linear, 1 KΩ)	1-ch, RCA (Linear, 1 KΩ)
Decoding format	H.265/H.265+/H.264/H.264+/MPEG4	H.265/H.265+/H.264/H.264+/MPEG4	H.265/H.265+/H.264/H.264+/MPEG4	H.265/H.265+/H.264/H.264+/MPEG4
Capability	2-ch @ 8 MP, or 8-ch @ 1080p	4-ch @ 4K, or 16-ch @ 1080p	12-ch @ 1080p	4-ch @ 4K, or 16-ch @ 1080p
SATA	2 SATA interfaces for 2 HDDs	2 SATA interfaces for 2 HDDs	2 SATA interfaces for four 3.5-inch HDDs	4 SATA interfaces for 4 HDDs
Capacity	Up to 6TB capacity for each HDD	Up to 6TB capacity for each HDD	Up to 8 TB capacity for each HDD	Up to 6TB capacity for each HDD
Network interface	1 RJ-45 10/100/1000 Mbps self-adaptive Ethernet interface	1 RJ-45 10/100/1000 Mbps self-adaptive Ethernet interface	1, RJ-45 10/100/1000 Mbps self-adaptive Ethernet interface	2 RJ-45 10/100/1000 Mbps self-adaptive Ethernet interfaces
USB interface	Front panel: 1 × USB 2.0; Rear panel: 1 × USB 3.0	Front panel: 1 × USB 2.0; Rear panel: 1 × USB 3.0	Front panel: 1 × USB 2.0; Rear panel: 1 × USB 3.0	Front panel: 2 × USB 2.0; Rear panel: 1 × USB 3.0
Alarm in/out	4/1	4/1	4/1	16/4
Power supply	100 to 240 VAC, 50 to 60 Hz	100 to 240 VAC, 50 to 60 Hz	100 to 240 VAC	100 to 240 VAC
Consumption(without hard disk or DVD-R/W)	≤15 W	≤15 W	≤ 15 W	≤20 W
Working temperature	-10 to +55° C (+14 to +131° F)	-10 to +55° C (+14 to +131° F)	-10 to +55° C (+14 to +131° F)	-10 to +55° C (+14 to +131° F)
Working humidity	10 to 90 %	10 to 90 %	10 to 90 %	10 to 90 %
Dimensions(W × D × H)	385 × 315 × 52 mm (15.2" × 12.4" × 2.0")	385 × 315 × 52 mm (15.2" × 12.4" × 2.0")	380 × 315 × 51.5 mm (15.0" × 12.4" × 2.0")	445 × 400 × 71 mm (17.5" × 15.7" × 2.8")



Short Description	DS-7700NI-I4/P SERIES NVR	DS-7700NI-K4 SERIES NVR	DS-7700NXI-I/P/S SERIES NVR	DS-7700NI-I4 SERIES NVR
Model	DS-7716NI-I4/16P	DS-7716NI-K4	DS-7716NXI-I4/16P/4S	DS-7732NI-I4(B)
IP video input	16-ch	16-ch	16-ch	32-ch
Incoming bandwidth	160 Mbps	160 Mbps	256 Mbps	80 Mbps
Outgoing bandwidth	256 Mbps	160 Mbps	200 Mbps	256 Mbps
Recording resolution	12MP/8 MP/6MP/5 MP/4MP/3MP/1080p/UXGA/720p/VGA/4CIF/DCIF/2CIF/CIF/QCIF	8MP/6MP/5MP/4MP/3MP/1080p/UXGA/720p/VGA/4CIF/DCIF/2CIF/CIF/QCIF	12 MP/8 MP/6 MP/5 MP/4 MP/3 MP/1080p/UXGA/720p/VGA/4CIF/DCIF/2CIF/CIF/QCIF	12MP/8MP/6 MP/5 MP/4MP/3MP/1080p/UXGA/720p/VGA/4CIF/DCIF/2CIF/CIF/QCIF
HDMI output	4K (3840 × 2160)/60Hz, 4K (3840 × 2160)/30Hz, 1920 × 1080p/60Hz, 1600 × 1200/60Hz, 1280 × 1024/60Hz, 1280 × 720/60Hz, 1024 × 768/60Hz	4K (3840 × 2160)/30Hz, 2K (2560 × 1440)/60Hz, 1920 × 1080/60Hz, 1600 × 1200/60Hz, 1280 × 1024/60Hz, 1280 × 720/60Hz, 1024 × 768/60Hz	4K (3840 × 2160)/30Hz, 1920 × 1080/60Hz, 1600 × 1200/60Hz, 1280 × 1024/60Hz, 1280 × 720/60Hz, 1024 × 768/60Hz	4K (3840 × 2160)/60Hz, 4K (3840 × 2160)/30Hz, 1920 × 1080p/60Hz, 1600 × 1200/60Hz, 1280 × 1024/60Hz, 1280 × 720/60Hz, 1024 × 768/60Hz
VGA output	1920 × 1080p/60Hz, 1280 × 1024/60Hz, 1280 × 720/60Hz, 1024 × 768/60Hz	1920 × 1080/60Hz, 1280 × 1024/60Hz, 1280 × 720/60Hz, 1024 × 768/60Hz	1920 × 1080/60Hz, 1600 × 1200/60Hz, 1280 × 1024/60Hz, 1280 × 720/60Hz, 1024 × 768/60Hz	2K(2560×1440)/60Hz, 1920 × 1080p/60Hz, 1280 × 1024/60Hz, 1280 × 720/60Hz, 1024 × 768/60Hz, HDMI1/VGA Simultaneous Output
Audio output	1-ch, RCA (Linear, 1 K Ω)	1-ch, RCA (Linear, 1 K Ω)	1-ch, RCA (Linear, 1 K Ω)	1-ch, RCA (Linear, 1 K Ω)
Decoding format	H.265/H.265+/H.264/H.264+/MPEG4	H.265/H.265+/H.264+/H.264+/MPEG4	H.265/H.265+/H.264/H.264+/MPEG4	H.265/H.265+/H.264/H.264+/MPEG4
Capability	4-ch @ 4K, or 16-ch @ 1080p	2-ch @ 8 MP (25fps) / 4-ch @ 4MP (30fps) / 8-ch @ 1080p (30fps)	12-ch @ 1080p	2-ch @ 12 MP (20fps) / 4-ch @ 8 MP (25fps) / 8-ch @ 4MP (30fps) / 16-ch @ 1080p (30fps)
SATA	4 SATA interfaces for 4 HDDs	4 SATA interfaces for 4 HDDs	4 SATA interfaces for four 3.5-inch HDDs	4 SATA interfaces for 4 HDDs
Capacity	Up to 6TB capacity for each HDD	Up to 6TB capacity for each HDD	Up to 8 TB capacity for each HDD	Up to 8TB capacity for each HDD
Network interface	1 RJ-45 10/100/1000 Mbps self-adaptive Ethernet interface	2 RJ-45 10/100/1000 Mbps self-adaptive Ethernet interfaces	1, RJ-45 10/100/1000 Mbps self-adaptive Ethernet interface	2 RJ-45 10/100/1000 Mbps self-adaptive Ethernet interfaces
USB interface	Front panel: 2 × USB 2.0; Rear panel: 1 × USB 3.0	Front panel: 2 × USB 2.0; Rear panel: 1 × USB 3.0	Front panel: 2 × USB 2.0; Rear panel: 1 × USB 3.0	Front panel: 2 × USB 2.0; Rear panel: 1 × USB 3.0
Alarm in/out	16/4	16/4	16/4	16/4
Power supply	100 to 240 VAC	100 to 240 VAC	100 to 240 VAC	100 to 240 VAC
Consumption(without hard disk or DVD-R/W)	≤20 W	≤ 20 W	≤ 300 W	≤20 W
Working temperature	-10 to +55° C (+14 to +131° F)	-10 to +55°C (14 to 131°F)	-10 to +55° C (+14 to +131° F)	-10 to +55° C (+14 to +131° F)
Working humidity	10 to 90 %	10 to 90 %	10 to 90 %	10 to 90 %
Dimensions(W × D × H)	445 × 400 × 71 mm (17.5" × 15.7" × 2.8")	445 × 400 × 71 mm (17.5" × 15.7" × 2.8")	445 × 400 × 71 mm (17.5" × 15.7" × 2.8")	445 × 400 × 71 mm (17.5" × 15.7" × 2.8")

Short Description	DS-7700NI-I4/P(B) SERIES NVR	DS-7700NI-K4 SERIES NVR	DS-7700NXI-I/S SERIES NVR
Model	DS-7732NI-I4/16P(B)	DS-7732NI-K4	DS-7732NXI-I4/4S
IP video input	32-ch	32-ch	32-ch
Incoming bandwidth	256 Mbps	256 Mbps	256 Mbps
Outgoing bandwidth	256 Mbps	160 Mbps	200 Mbps
Recording resolution	12MP/8 MP/6MP/5 MP/4MP/3MP/1080p/UXGA/720p/VGA/4CIF/DCIF/2CIF/CIF/QCIF	8MP/6MP/5MP/4MP/3MP/1080p/UXGA/720p/VGA/4CIF/DCIF/2CIF/CIF/QCIF	12 MP/8 MP/6 MP/5 MP/4 MP/3 MP/1080p/UXGA/720p/VGA/4CIF/DCIF/2CIF/CIF/QCIF
HDMI output	4K (3840 × 2160)/60Hz, 4K (3840 × 2160)/30Hz, 1920 × 1080p/60Hz, 1600 × 1200/60Hz, 1280 × 1024/60Hz, 1280 × 720/60Hz, 1024 × 768/60Hz	4K (3840 × 2160)/30Hz, 2K (2560 × 1440)/60Hz, 1920 × 1080/60Hz, 1600 × 1200/60Hz, 1280 × 1024/60Hz, 1280 × 720/60Hz, 1024 × 768/60Hz	4K (3840 × 2160)/30Hz, 1920 × 1080/60Hz, 1600 × 1200/60Hz, 1280 × 1024/60Hz, 1280 × 720/60Hz, 1024 × 768/60Hz
VGA output	1920 × 1080p/60Hz, 1280 × 1024/60Hz, 1280 × 720/60Hz, 1024 × 768/60Hz	1920 × 1080/60Hz, 1280 × 1024/60Hz, 1280 × 720/60Hz, 1024 × 768/60Hz	1920 × 1080/60Hz, 1600 × 1200/60Hz, 1280 × 1024/60Hz, 1280 × 720/60Hz, 1024 × 768/60Hz
Audio output	1-ch, RCA (Linear, 1 K Ω)	1-ch, RCA (Linear, 1 K Ω)	1-ch, RCA (Linear, 1 K Ω)
Decoding format	H.265/H.265+/H.264/H.264+/MPEG4	H.265/H.265+/H.264+/H.264+/MPEG4	H.265/H.265+/H.264/H.264+/MPEG4
Capability	2-ch @ 12 MP (20fps) / 4-ch @ 8 MP (25fps) / 8-ch @ 4MP (30fps) / 16-ch @ 1080p (30fps)	2-ch @ 8 MP (25fps) / 4-ch @ 4MP (30fps) / 8-ch @ 1080p (30fps)	12-ch @ 1080p
SATA	4 SATA interfaces for 4 HDDs	4 SATA interfaces for 4 HDDs	4 SATA interfaces for four 3.5-inch HDDs
Capacity	Up to 8 TB capacity for each HDD	Up to 6TB capacity for each HDD	Up to 8 TB capacity for each HDD
Network interface	1 RJ-45 10/100/1000 Mbps self-adaptive Ethernet interface	2 RJ-45 10/100/1000 Mbps self-adaptive Ethernet interfaces	2, RJ-45 10/100/1000 Mbps self-adaptive Ethernet interface
USB interface	Front panel: 2 × USB 2.0; Rear panel: 1 × USB 3.0	Front panel: 2 × USB 2.0; Rear panel: 1 × USB 3.0	Front panel: 2 × USB 2.0; Rear panel: 1 × USB 3.0
Alarm in/out	16/4 (16/8 optional)	16/4	16/4
Power supply	100 to 240 VAC	100 to 240 VAC	100 to 240 VAC
Consumption(without hard disk or DVD-R/W)	≤20 W	≤ 20 W	≤ 80 W
Working temperature	-10 to +55° C (+14 to +131° F)	-10 to +55°C (14 to 131°F)	-10 to +55° C (+14 to +131° F)
Working humidity	10 to 90 %	10 to 90 %	10 to 90 %
Dimensions(W × D × H)	445 × 400 × 71 mm (17.5" × 15.7" × 2.8")	445 × 400 × 71 mm (17.5" × 15.7" × 2.8")	445 × 400 × 71 mm (17.5" × 15.7" × 2.8")

1U CHASSIS



Short Description	DS-7600NI-K1 Series NVR	DS-7600NI-K1/4P SERIES NVR	DS-7600NI-K1 Series NVR	DS-7600NI-K2 SERIES NVR
Model	DS-7604NI-K1(B)	DS-7604NI-K1/4P(B)	DS-7608NI-K1(B)	DS-7608NI-K2
IP video input	4-ch	4-ch	8-ch	8-ch
Incoming bandwidth	40 Mbps	40 Mbps	80 Mbps	80 Mbps
Outgoing bandwidth	80 Mbps	80 Mbps	80 Mbps	160 Mbps
Recording resolution	8MP/6MP/5MP/4MP/3MP/1080p/UXGA/720p/VGA/4CIF/DCIF/2CIF/CIF/QCIF	8MP/6MP/5MP/4MP/3MP/1080p/UXGA/720p/VGA/4CIF/DCIF/2CIF/CIF/QCIF	8MP/6MP/5MP/4MP/3MP/1080p/UXGA/720p/VGA/4CIF/DCIF/2CIF/CIF/QCIF	8MP/6MP/5MP/4MP/3MP/1080p/UXGA/720p/VGA/4CIF/DCIF/2CIF/CIF/QCIF
HDMI output	1-ch, 4K (3840 × 2160)/30Hz, 1920 × 1080p/60Hz, 1600 × 1200/60Hz, 1280 × 1024/60Hz, 1280 × 720/60Hz, 1024 × 768/60Hz; HDMI/VGA simultaneous output	1-ch, 4K (3840 × 2160)/30Hz, 1920 × 1080p/60Hz, 1600 × 1200/60Hz, 1280 × 1024/60Hz, 1280 × 720/60Hz, 1024 × 768/60Hz; HDMI/VGA simultaneous output	1-ch, 4K (3840 × 2160)/30Hz, 1920 × 1080p/60Hz, 1600 × 1200/60Hz, 1280 × 1024/60Hz, 1280 × 720/60Hz, 1024 × 768/60Hz	4K (3840 × 2160)/30Hz, 2K (2560 × 1440)/60Hz, 1920 × 1080/60Hz, 1600 × 1200/60Hz, 1280 × 1024/60Hz, 1280 × 720/60Hz, 1024 × 768/60Hz
VGA output	1-ch, 1920 × 1080p/60Hz, 1600 × 1200/60Hz, 1280 × 1024/60Hz, 1280 × 720/60Hz, 1024 × 768/60Hz; HDMI/VGA simultaneous output	1-ch, 1920 × 1080p/60Hz, 1600 × 1200/60Hz, 1280 × 1024/60Hz, 1280 × 720/60Hz, 1024 × 768/60Hz; HDMI/VGA simultaneous output	1-ch, 1920 × 1080p/60Hz, 1280 × 1024/60Hz, 1280 × 720/60Hz, 1024 × 768/60Hz	1920 × 1080/60Hz, 1280 × 1024/60Hz, 1280 × 720/60Hz, 1024 × 768/60Hz
Audio output	1-ch, RCA (Linear, 1 KΩ)	1-ch, RCA (Linear, 1 KΩ)	1-ch, RCA (Linear, 1 KΩ)	1-ch, RCA (Linear, 1 KΩ)
Decoding format	H.265/H.265+/H.264/H.264+/MPEG4	H.265/H.265+/H.264/H.264+/MPEG4	H.265/H.265+/H.264/H.264+/MPEG4	H.265/H.265+/H.264/H.264+/MPEG4
Capability	1-ch @ 8 MP / 4-ch @ 1080p	1-ch @ 8 MP / 4-ch @ 1080p	1-ch @ 8 MP / 4-ch @ 1080p	2-ch @ 8 MP (25fps) / 4-ch @ 4MP (30fps) / 8-ch @ 1080p (30fps)
SATA	1 SATA interface	1 SATA interface	1 SATA interface	2 SATA interfaces for 2 HDDs
Capacity	Up to 6TB capacity for each disk	Up to 6TB capacity for each disk	Up to 6TB capacity for each disk	Up to 6TB capacity for each HDD
Network interface	1, RJ-45 10/100/1000 Mbps self-adaptive Ethernet interface	1, RJ-45 10/100/1000 Mbps self-adaptive Ethernet interface	1, RJ-45 10/100/1000 Mbps self-adaptive Ethernet interface	1, RJ-45 10/100/1000 Mbps self-adaptive Ethernet interface
USB interface	2 × USB 2.0	2 × USB 2.0	2 × USB 2.0	Front panel: 1 × USB 2.0; Rear panel: 1 × USB 3.0
Alarm in/out				4/1
Power supply	12 VDC, ≤ 18W	48 VDC, ≤ 65 W	12 VDC, ≤ 18W	12 VDC
Consumption(without hard disk or DVD-R/W)	≤ 10 W	≤ 10 W (without enabling PoE)	≤ 10 W	≤ 15 W
Working temperature	-10 to +55° C (+14 to +131° F)	-10 to +55° C (14 to 131° F)	-10 to +55° C (+14 to +131° F)	-10 to +55° C (14 to 131° F)
Working humidity	10 to 90 %	10 to 90 %	10 to 90 %	10 to 90 %
Dimensions(W × D × H)	315 × 240 × 48 mm (12.4" × 9.4" × 1.9")	315 × 240 × 48 mm (12.4" × 9.4" × 1.9")	315 × 240 × 48 mm (12.4" × 9.4" × 1.9")	385 × 315 × 52 mm (15.2" × 12.4" × 2.0")

Short Description	DS-7600NI-K2/P SERIES NVR	DS-7600NI-K1 Series NVR	DS-7600NI-K2 SERIES NVR	DS-7600NI-K2/P SERIES NVR
Model	DS-7608NI-K2/8P	DS-7616NI-K1(B)	DS-7616NI-K2	DS-7616NI-K2/16P
IP video input	8-ch	16-ch	16-ch	16-ch
Incoming bandwidth	80 Mbps	160 Mbps	160 Mbps	160 Mbps
Outgoing bandwidth	160 Mbps	80 Mbps	160 Mbps	160 Mbps
Recording resolution	8MP/6MP/5MP/4MP/3MP/1080p/UXGA/720p/VGA/4CIF/DCIF/2CIF/CIF/QCIF	8MP/6MP/5MP/4MP/3MP/1080p/UXGA/720p/VGA/4CIF/DCIF/2CIF/CIF/QCIF	8MP/6MP/5MP/4MP/3MP/1080p/UXGA/720p/VGA/4CIF/DCIF/2CIF/CIF/QCIF	8MP/6MP/5MP/4MP/3MP/1080p/UXGA/720p/VGA/4CIF/DCIF/2CIF/CIF/QCIF
HDMI output	4K (3840 × 2160)/30Hz, 2K (2560 × 1440)/60Hz, 1920 × 1080/60Hz, 1600 × 1200/60Hz, 1280 × 1024/60Hz, 1280 × 720/60Hz, 1024 × 768/60Hz	1-ch, 4K (3840 × 2160)/30Hz, 1920 × 1080p/60Hz, 1600 × 1200/60Hz, 1280 × 1024/60Hz, 1280 × 720/60Hz, 1024 × 768/60Hz	4K (3840 × 2160)/30Hz, 2K (2560 × 1440)/60Hz, 1920 × 1080/60Hz, 1600 × 1200/60Hz, 1280 × 1024/60Hz, 1280 × 720/60Hz, 1024 × 768/60Hz	4K (3840 × 2160)/30Hz, 2K (2560 × 1440)/60Hz, 1920 × 1080/60Hz, 1600 × 1200/60Hz, 1280 × 1024/60Hz, 1280 × 720/60Hz, 1024 × 768/60Hz
VGA output	1920 × 1080/60Hz, 1280 × 1024/60Hz, 1280 × 720/60Hz, 1024 × 768/60Hz	1-ch, 1920 × 1080p/60Hz, 1280 × 1024/60Hz, 1280 × 720/60Hz, 1024 × 768/60Hz	1920 × 1080/60Hz, 1280 × 1024/60Hz, 1280 × 720/60Hz, 1024 × 768/60Hz	1920 × 1080/60Hz, 1280 × 1024/60Hz, 1280 × 720/60Hz, 1024 × 768/60Hz
Audio output	1-ch, RCA (Linear, 1 KΩ)	1-ch, RCA (Linear, 1 KΩ)	1-ch, RCA (Linear, 1 KΩ)	1-ch, RCA (Linear, 1 KΩ)
Decoding format	H.265/H.265+/H.264/H.264+/MPEG4	H.265/H.265+/H.264/H.264+/MPEG4	H.265/H.265+/H.264/H.264+/MPEG4	H.265/H.265+/H.264/H.264+/MPEG4
Capability	2-ch @ 8 MP (25fps) / 4-ch @ 4MP (30fps) / 8-ch @ 1080p (30fps)	1-ch @ 8 MP / 4-ch @ 1080p	2-ch @ 8 MP (25fps) / 4-ch @ 4MP (30fps) / 8-ch @ 1080p (30fps)	2-ch @ 8 MP (25fps) / 4-ch @ 4MP (30fps) / 8-ch @ 1080p (30fps)
SATA	2 SATA interfaces for 2 HDDs	1 SATA interface	2 SATA interfaces for 2 HDDs	2 SATA interfaces for 2 HDDs
Capacity	Up to 6TB capacity for each HDD	Up to 6TB capacity for each disk	Up to 6TB capacity for each HDD	Up to 6TB capacity for each HDD
Network interface	1, RJ-45 10/100/1000 Mbps self-adaptive Ethernet interface	1, RJ-45 10/100/1000 Mbps self-adaptive Ethernet interface	1, RJ-45 10/100/1000 Mbps self-adaptive Ethernet interface	1 RJ-45 10/100/1000 Mbps self-adaptive Ethernet interface
USB interface	Front panel: 1 × USB 2.0; Rear panel: 1 × USB 3.0	2 × USB 2.0	Front panel: 1 × USB 2.0; Rear panel: 1 × USB 3.0	Front panel: 1 × USB 2.0; Rear panel: 1 × USB 3.0
Alarm in/out	4/1		4/1	4/1
Power supply	100 to 240 VAC	12 VDC, ≤ 18W	12 VDC	100 to 240 VAC
Consumption(without hard disk or DVD-R/W)	≤ 15 W	≤ 10 W	≤ 15 W	≤ 15 W
Working temperature	-10 to +55° C (+14 to +131° F)	-10 to +55° C (+14 to +131° F)	-10 to +55° C (14 to 131° F)	-10 to +55° C (14 to 131° F)
Working humidity	10 to 90 %	10 to 90 %	10 to 90 %	10 to 90 %
Dimensions(W × D × H)	385 × 315 × 52 mm (15.2" × 12.4" × 2.0")	315 × 240 × 48 mm (12.4" × 9.4" × 1.9")	385 × 315 × 52 mm (15.2" × 12.4" × 2.0")	385 × 315 × 52 mm (15.2" × 12.4" × 2.0")



H.265+ GREAT PERFORMANCE

LOW BANDWIDTH

Hikvision lifts video surveillance to an unprecedented level with its H.265+ codec. In Full HD mode, H.265+ uses less

MINIMUM STORAGE

H.265+ also greatly outperforms all its predecessors in terms of storage. Regardless of environment or application, H.265+ reduces the required storage space by more than 80%.

In short, H.265+ allows you to kill two birds with one stone: you can now record images at amazingly high resolutions and minimize the required storage capacity. This makes H.265+ the ideal solution for 24-hour surveillance!



DIGITAL VIDEO RECORDERS (DVRs)

Because Hikvision realizes that not all solutions are based on IP technology, we evolve existing technologies to provide the widest range of products to for all applications. This can be seen in the state-of-the-art DVR products, which offer the best of both worlds.

NAME CODING RULE

DS-	72	08	HUH	I	-F	2	/N
DS-: General Products iDS-: Intelligent products	Product Series DVR: 71/ 72/ 73/ 76/ 81/ 90 Encoder: 60/ 61/ 65/ 66/ 67	Analog Channel No. Range from 01 to 32.	Stands for the encoding resolution of DVR HC: CIF HD/HE: 2CIF HF: 4CIF HW: WD1 HFH: HD-SDI HGH: 720p/ 1080p lite HQH: 1080P/ 4 MP lite HUH: 3 MP/5 MP / 8 MP HTH:8MP	I stands for international	Stands for the product generation no. New generation: -K Old generation: -S, -ST, -SH, -E, -F	Supported hard drive no. Range from 1 to 16	Extended function and features /P: PoC built-in models /xN: non-realtime /xS: smart analysis channel

1U CHASSIS

Short Description	DS-7200HQHI-K1 SERIES TURBO HD DVR	DS-7200HUHI-K1 SERIESTURBO HD DVR	DS-7200HUHI-K/P SERIES TURBO HD DVR
Model	DS-7204HQHI-K1(S)	DS-7204HUHI-K1(S)	DS-7204HUHI-K1/P
Video compression	H.265 Pro+/H.265 Pro/H.265/H.264+/H.264		H.265+/H.265/H.264+/H.264
Analog video input	4-ch		1-ch
HD-TVI video input	4 MP, 3 MP, 1080p30, 1080p25, 720p60, 720p50, 720p30, 720p25	8 MP, 5 MP, 4 MP, 3 MP, 1080p30, 1080p25, 720p60, 720p50, 720p30, 720p25	5 MP, 4 MP, 3 MP, 1080p30, 1080p25, 720p60, 720p50, 720p30, 720p25
IP video input	2-ch (up to 6-ch)	4-ch (up to 8-ch)	2-ch, Up to 6 MP resolution, Supports H.265+/H.265/H.264+/H.264 IP cameras
Audio compression	6.711u	6.711u	6.711u
Audio input	1-ch, RCA [2.0 Vp-p, 1 KΩ]	4-ch, RCA [2.0 Vp-p, 1 KΩ]	4-ch, RCA [2.0 Vp-p, 1 KΩ]
Two-way audio in	1-ch, RCA [2.0 Vp-p, 1 KΩ] (using the first audio input)	1-ch, RCA [2.0 Vp-p, 1 KΩ] (using the first audio input)	1-ch, RCA [2.0 Vp-p, 1 KΩ] (using the first audio input)
HDMI/VGA output	1-ch, 1920 × 1080/60Hz, 1280 × 1024/60Hz, 1280 × 720/60Hz, 1024 × 768/60Hz	1-ch, 1920 × 1080/60Hz, 1280 × 1024/60Hz, 1280 × 720/60Hz, 1024 × 768/60Hz	1-ch, 1920 × 1080/60Hz, 1280 × 1024/60Hz, 1280 × 720/60Hz, 1024 × 768/60Hz
CVBS output	1-ch, BNC [1.0 Vp-p, 75 Ω], resolution: PAL: 704 × 576, NTSC: 704 × 480	1-ch, BNC [1.0 Vp-p, 75 Ω], resolution: PAL: 704 × 576, NTSC: 704 × 480	1-ch, BNC [1.0 Vp-p, 75 Ω], resolution: PAL: 704 × 576, NTSC: 704 × 480
Encoding resolution	When 1080p lite mode is not enabled: 4 MP lite/3 MP/1080p/720p/VGA/WD1/4CIF/CIF When 1080p Lite mode is enabled: 4 MP lite/3 MP/1080p lite/720p lite/VGA/WD1/4CIF/CIF	When 8 MP Lite mode is not enabled: 8 MP/5 MP/4 MP/3 MP/1080p/720p/WD1/4CIF/VGA/CIF When 8 MP Lite mode is enabled: 8 MP Lite/5 MP/4 MP/3MP/1080P/720P/WD1/4CIF/VGA/CIF	5 MP/4 MP/3 MP/1080p/720p/WD1/4CIF/VGA/CIF
Video bitrate	32 Kbps to 6 Mbps	32 Kbps to 10 Mbps	32 Kbps to 10 Mbps
Audio output	1-ch, RCA [Linear, 1 KΩ]	1-ch, RCA [Linear, 1 KΩ]	1-ch, RCA [Linear, 1 KΩ]
Audio bitrate	64 Kbps	64 Kbps	64 Kbps
Synchronous playback	4-ch	4-ch	4-ch
SATA	1 SATA interface	1 SATA interface	1 SATA interface
Capacity	Up to 10 TB capacity for each disk	Up to 10 TB capacity for each disk	Up to 8 TB capacity for each disk
Network interface	1, RJ45 10M/100M self-adaptive Ethernet interface	1, RJ45 10M/100M/1000M self-adaptive Ethernet interface	1, RJ45 10M/100M self-adaptive Ethernet interface
USB port	2 × USB 2.0	Front panel: 1 × USB 2.0 Rear panel: 1 × USB 3.0	2 × USB 2.0
Alarm in/out	N/A	N/A	4/1
Power supply	12 VDC	12 VDC	48 VDC
Working temperature	-10 °C to +55 °C (+14 °F to +131 °F)	-10 °C to +55 °C (+14 °F to +131 °F)	-10 °C to +55 °C (+14 °F to +131 °F)
Working humidity	10% to 90%	10% to 90%	10% to 90%
Dimensions(W × D × H)	315 × 242 × 45 mm [12.4 × 9.5 × 1.8 inch]		315 × 242 × 45 mm [12.4 × 9.5 × 1.8 inch]

Short Description	DS-7200HQHI-K1 SERIES TURBO HD DVR	DS-7200HUHI-K1 SERIESTURBO HD DVR	DS-7200HUHI-K/P SERIES TURBO HD DVR
Model	DS-7208HQHI-K1(S)	DS-7208HUHI-K1(S)	DS-7208HUHI-K2/P
Video compression	H.265 Pro+/H.265 Pro/H.265/H.264+/H.264		H.265+/H.265/H.264+/H.264
Analog video input	8-ch		1-ch
HD-TVI video input	4 MP, 3 MP, 1080p30, 1080p25, 720p60, 720p50, 720p30, 720p25	8 MP, 5 MP, 4 MP, 3 MP, 1080p30, 1080p25, 720p60, 720p50, 720p30, 720p25	5 MP, 4 MP, 3 MP, 1080p30, 1080p25, 720p60, 720p50, 720p30, 720p25
IP video input	4-ch (up to 12-ch)	8-ch (up to 16-ch)	2-ch, Up to 6 MP resolution, Supports H.265+/H.265/H.264+/H.264 IP cameras
Audio compression	6.711u	6.711u	6.711u
Audio input	1-ch, RCA [2.0 Vp-p, 1 KΩ]	4-ch, RCA [2.0 Vp-p, 1 KΩ]	4-ch, RCA [2.0 Vp-p, 1 KΩ]
Two-way audio in	1-ch, RCA [2.0 Vp-p, 1 KΩ] (using the first audio input)	1-ch, RCA [2.0 Vp-p, 1 KΩ] (using the first audio input)	1-ch, RCA [2.0 Vp-p, 1 KΩ] (using the first audio input)
HDMI/VGA output	1-ch, 1920 × 1080/60Hz, 1280 × 1024/60Hz, 1280 × 720/60Hz, 1024 × 768/60Hz	1-ch, 1920 × 1080/60Hz, 1280 × 1024/60Hz, 1280 × 720/60Hz, 1024 × 768/60Hz	VGA: 1-ch, 1920 × 1080/60Hz, 1280 × 1024/60Hz, 1280 × 720/60Hz, 1024 × 768/60HzHDMI: 1-ch, 4K [3840 × 2160]/30Hz, 2K [2560 × 1440]/60Hz, 1920 × 1080/60Hz, 1280 × 1024/60Hz, 1280 × 720/60Hz, 1024 × 768/60Hz
CVBS output	1-ch, BNC [1.0 Vp-p, 75 Ω], resolution: PAL: 704 × 576, NTSC: 704 × 480	1-ch, BNC [1.0 Vp-p, 75 Ω], resolution: PAL: 704 × 576, NTSC: 704 × 480	1-ch, BNC [1.0 Vp-p, 75 Ω], resolution: PAL: 704 × 576, NTSC: 704 × 480
Encoding resolution	When 1080p lite mode is not enabled: 4 MP lite/3 MP/1080p/720p/VGA/WD1/4CIF/CIF When 1080p Lite mode is enabled: 4 MP lite/3 MP/1080p lite/720p lite/VGA/WD1/4CIF/CIF	When 8 MP Lite mode is not enabled: 8 MP/5 MP/4 MP/3 MP/1080p/720p/WD1/4CIF/VGA/CIF When 8 MP Lite mode is enabled: 8 MP Lite/5 MP/4 MP/3MP/1080P/720P/WD1/4CIF/VGA/CIF	5 MP/4 MP/3 MP/1080p/720p/WD1/4CIF/VGA/CIF
Video bitrate	32 Kbps to 6 Mbps	32 Kbps to 10 Mbps	32 Kbps to 10 Mbps
Audio output	1-ch, RCA [Linear, 1 KΩ]	1-ch, RCA [Linear, 1 KΩ]	1-ch, RCA [Linear, 1 KΩ]
Audio bitrate	64 Kbps	64 Kbps	64 Kbps
Synchronous playback	8-ch	8-ch	8-ch
SATA	1 SATA interface	1 SATA interface	2 SATA interfaces
Capacity	Up to 10 TB capacity for each disk	Up to 10 TB capacity for each disk	Up to 8 TB capacity for each disk
Network interface	1, RJ45 10M/100M self-adaptive Ethernet interface	1, RJ45 10M/100M/1000M self-adaptive Ethernet interface	1, RJ45 10M/100M/1000M self-adaptive Ethernet interface
USB port	2 × USB 2.0	Front panel: 1 × USB 2.0 Rear panel: 1 × USB 3.0	Front panel: 1 × USB 2.0Rear panel: 1 × USB 3.0
Alarm in/out	N/A	N/A	8/4
Power supply	12 VDC	12 VDC	48 VDC
Working temperature	-10 °C to +55 °C (+14 °F to +131 °F)	-10 °C to +55 °C (+14 °F to +131 °F)	-10 °C to +55 °C (+14 °F to +131 °F)
Working humidity	10% to 90%	10% to 90%	10% to 90%
Dimensions(W × D × H)	315 × 242 × 45 mm [12.4 × 9.5 × 1.8 inch]		380 × 320 × 48 mm [15.0 × 12.6 × 1.9 inch]

Short Description	DS-7200HQHI-K1 SERIES TURBO HD DVR	DS-7200HQHI-K2 SERIES TURBO HD DVR	DS-7200HUHI-K2 SERIES TURBO HD DVR
Model	DS-7216HQHI-K1(S)	DS-7216HQHI-K2(S)	DS-7216HUHI-K2(S)
Video compression	H.265 Pro+/H.265 Pro/H.265/H.264+/H.264	H.265 Pro+/H.265 Pro/H.265/H.264+/H.264	H.265 Pro+/H.265 Pro/H.265/H.264+/H.264
Analog video input	16-ch	16-ch	16-ch
HD-TVI video input	4 MP, 3 MP, 1080p30, 1080p25, 720p60, 720p50, 720p30, 720p25	4 MP, 3 MP, 1080p30, 1080p25, 720p60, 720p50, 720p30, 720p25	8 MP, 5 MP, 4 MP, 3 MP, 1080p30, 1080p25, 720p60, 720p50, 720p30, 720p25
IP video input	8-ch (up to 24-ch)	8-ch (up to 24-ch)	16-ch (up to 32-ch)
Audio compression	6.711u	6.711u	6.711u
Audio input	1-ch, RCA (2.0 Vp-p, 1 K Ω)	1-ch, RCA (2.0 Vp-p, 1 K Ω)	4-ch, RCA (2.0 Vp-p, 1 K Ω)
Two-way audio in	1-ch, RCA (2.0 Vp-p, 1 K Ω) (using the first audio input)	1-ch, RCA (2.0 Vp-p, 1 K Ω) (using the first audio input)	1-ch, RCA (2.0 Vp-p, 1 K Ω) (using the first audio input)
HDMI/VGA output	1-ch, 4K (3840 × 2160)/30Hz, 2K (2560 × 1440)/60Hz, 1920 × 1080/60Hz, 1280 × 1024/60Hz, 1280 × 720/60Hz, 1024 × 768/60Hz	1-ch, RCA (2.0 Vp-p, 1 K Ω) (using the first audio input)	1-ch, 1920 × 1080/60Hz, 1280 × 1024/60Hz, 1280 × 720/60Hz, 1024 × 768/60Hz
CVBS output	1-ch, BNC (1.0 Vp-p, 75 Ω), resolution: PAL: 704 × 576, NTSC: 704 × 480	PAL/NTSC	1-ch, BNC (1.0 Vp-p, 75 Ω), resolution: PAL: 704 × 576, NTSC: 704 × 480
Encoding resolution	When 1080p lite mode is not enabled: 4 MP lite/3 MP/1080p/720p/VGA/WD1/4CIF/CIF When 1080p Lite mode is enabled: 4 MP lite/3 MP/1080p lite/720p lite/VGA/WD1/4CIF/CIF	When 1080p lite mode is not enabled: 4 MP lite/3 MP/1080p/720p/VGA/WD1/4CIF/CIF When 1080p Lite mode is enabled: 4 MP lite/3 MP/1080p lite/720p lite/VGA/WD1/4CIF/CIF	When 8 MP Lite mode is not enabled: 8 MP/5 MP/4 MP/3 MP/1080p/720p/WD1/4CIF/VGA/CIF When 8 MP Lite mode is enabled: 8 MP Lite/5 MP/4 MP/3MP/1080P/720P/WD1/4CIF/VGA/CIF
Video bitrate	32 Kbps to 6 Mbps	32 Kbps to 6 Mbps	32 Kbps to 10 Mbps
Audio output	1-ch, RCA (Linear, 1 K Ω)	1-ch, RCA (Linear, 1 K Ω)	1-ch, RCA (Linear, 1 K Ω)
Audio bitrate	64 Kbps	64 Kbps	64 Kbps
Synchronous playback	16-ch	16-ch	16-ch
SATA	1 SATA interface	2 SATA interfaces	2 SATA interfaces
Capacity	Up to 10 TB capacity for each disk	Up to 10 TB capacity for each disk	Up to 10 TB capacity for each disk
Network interface	1, RJ45 10M/100M/1000M self-adaptive Ethernet interface	1, RJ45 10M/100M/1000M self-adaptive Ethernet interface	1, RJ45 10M/100M/1000M self-adaptive Ethernet interface
USB port	Front panel: 1 × USB 2.0 Rear panel: 1 × USB 3.0	Front panel: 1 × USB 2.0 Rear panel: 1 × USB 3.0	Front panel: 1 × USB 2.0 Rear panel: 1 × USB 3.0
Alarm in/out	N/A	N/A	16/4
Power supply	12 VDC	12 VDC	12 VDC
Working temperature	-10 °C to +55 °C (+14 °F to +131 °F)	-10 °C to +55 °C (+14 °F to +131 °F)	-10 °C to +55 °C (+14 °F to +131 °F)
Working humidity	10% to 90%	10% to 90%	10% to 90%
Dimensions(W × D × H)	315 × 242 × 45 mm (12.4 × 9.5 × 1.8 inch)	380 × 320 × 48 mm (15.0 × 12.6 × 1.9 inch)	380 × 320 × 48 mm (15.0 × 12.6 × 1.9 inch)

1.5U CHASSIS



Short Description	DS-7324HUHI-K4 SERIES TURBO HD DVR	DS-7332HUHI-K4 SERIES TURBO HD DVR	iDS-7200HQHI-M1/S SERIES TURBO ACUSENSE DVR
Model	DS-7324HUHI-K4	DS-7332HUHI-K4	iDS-7204HQHI-M1/S
Video compression	H.265+/H.265/H.264+/H.264	H.265+/H.265/H.264+/H.264	H.265 Pro+/H.265 Pro/H.265/H.264+/H.264
Analog video input	24-ch	32-ch	4-ch
HD-TVI video input	5 MP, 4 MP, 3 MP, 1080p25, 1080p30, 720p25, 720p30, 720p50, 720p60	5 MP, 4 MP, 3 MP, 1080p25, 1080p30, 720p25, 720p30, 720p50, 720p60	3 MP, 1080p30, 1080p@25 fps, 720p@60 fps, 720p@50 fps, 720p@30 fps, 720p@25 fps
IP video input	8-ch (up to 32-ch), Up to 8 MP resolution, Supports H.265+/H.265/H.264+/H.264 IP cameras	8-ch (up to 40-ch), Up to 8 MP resolution, Supports H.265+/H.265/H.264+/H.264 IP cameras	1-ch (up to 5-ch), Up to 6 MP resolution Support H.265+/H.265/H.264+/H.264 IP cameras
Audio compression	6.711u	6.711u	6.711u
Audio input	4-ch, RCA (2.0 Vp-p, 1 K Ω)	4-ch, RCA (2.0 Vp-p, 1 K Ω)	1-ch, RCA (2.0 Vp-p, 1 K Ω)
Two-way audio in	1-ch, RCA (2.0 Vp-p, 1 K Ω) (independent)	1-ch, RCA (2.0 Vp-p, 1 K Ω) (independent)	1-ch, RCA (2.0 Vp-p, 1 K Ω) (using the first audio input)
HDMI/VGA output	1-ch, 1920 × 1080/60Hz, 1280 × 1024/60Hz, 1280 × 720/60Hz, 1024 × 768/60Hz	1-ch, 1920 × 1080/60Hz, 1280 × 1024/60Hz, 1280 × 720/60Hz, 1024 × 768/60Hz	1-ch, 1920 × 1080/60Hz, 1280 × 1024/60Hz, 1280 × 720/60Hz, 1024 × 768/60Hz, HDMI/VGA simultaneous output
CVBS output	1-ch, BNC (1.0 Vp-p, 75 Ω), resolution: PAL: 704 × 576, NTSC: 704 × 480	1-ch, BNC (1.0 Vp-p, 75 Ω), resolution: PAL: 704 × 576, NTSC: 704 × 480	1-ch, BNC (1.0 Vp-p, 75 Ω), resolution: PAL: 704 × 576, NTSC: 704 × 480
Encoding resolution	5 MP/4 MP/3 MP/1080p/720p/WD1/4CIF/VGA/CIF	5 MP/4 MP/3 MP/1080p/720p/WD1/4CIF/VGA/CIF	When 1080p Lite mode enabled: 4 MP lite/3 MP@15 fps; 1080p lite/720p lite/VGA/WD1/4CIF/CIF@25 fps (P)/30 fps (N)
Video bitrate	32 Kbps to 10 Mbps	32 Kbps to 10 Mbps	32 Kbps to 6 Mbps
Audio output	1-ch, RCA (Linear, 1 K Ω)	1-ch, RCA (Linear, 1 K Ω)	1-ch, RCA (Linear, 1 K Ω)
Audio bitrate	64 Kbps	64 Kbps	64 Kbps
Synchronous playback	16-ch	16-ch	4-ch
SATA	4 SATA interfaces	4 SATA interfaces	1 SATA interface
Capacity	Up to 8 TB capacity for each disk	Up to 8 TB capacity for each disk	Up to 10 TB capacity for each disk
Network interface	2, RJ45 10M/100M/1000M self-adaptive Ethernet interface	2, RJ45 10M/100M/1000M self-adaptive Ethernet interface	1, RJ45 10M/100M self-adaptive Ethernet interface
USB port	Front panel: 2 × USB 2.0 Rear panel: 1 × USB 3.0	Front panel: 2 × USB 2.0 Rear panel: 1 × USB 3.0	Front panel: 1 × USB 2.0; Rear panel: 1 × USB 2.0
Alarm in/out	16/4	16/4	N/A
Power supply	100 to 240 VAC	100 to 240 VAC	12 VDC
Working temperature	-10 °C to +55 °C (+14 °F to +131 °F)	-10 °C to +55 °C (+14 °F to +131 °F)	-10 °C to 55 °C (14 °F to 131 °F)
Working humidity	10% to 90%	10% to 90%	10% to 90%
Dimensions(W × D × H)	440 × 390 × 70 mm (17.3 × 15.4 × 2.8 inch)	440 × 390 × 70 mm (17.3 × 15.4 × 2.8 inch)	315 × 242 × 45 mm (12.4 × 9.5 × 1.8 inch)

1U CHASSIS



Short Description	iDS-7200HUHI-M1/S SERIESTURBO ACUSENSE DVR	iDS-7200HQHI-M1/S SERIES TURBO ACUSENSE DVR	iDS-7200HUHI-M1/S SERIESTURBO ACUSENSE DVR
Model	iDS-7204HUHI-M1/S/A	iDS-7208HQHI-M1/S	iDS-7208HUHI-M1/S/A
Video compression	H.265 Pro+/H.265 Pro/H.265/H.264+/H.264	H.265 Pro+/H.265 Pro/H.265/H.264+/H.264	H.265 Pro+/H.265 Pro/H.265/H.264+/H.264
Analog video input	4-ch	8-ch	8-ch
HD-TVI video input	8 MP, 5 MP, 4 MP, 3 MP, 1080p30, 1080p@25 fps, 720p@60 fps, 720p@50 fps, 720p@30 fps, 720p@25 fps	3 MP, 1080p30, 1080p@25 fps, 720p@60 fps, 720p@50 fps, 720p@30 fps, 720p@25 fps	8 MP, 5 MP, 4 MP, 3 MP, 1080p@30 fps, 1080p@25 fps, 720p@60 fps, 720p@50 fps, 720p@30 fps, 720p@25 fps
IP video input	2-ch (up to 6-ch) IP enhanced mode on: 4-ch (up to 8-ch), each up to 4 Mbps	2-ch (up to 10-ch), Up to 6 MP resolution Support H.265+/H.265/H.264+/H.264 IP cameras	4-ch (up to 12-ch) IP enhanced mode on: 8-ch (up to 16-ch), each up to 4 Mbps
Audio compression	G.711u	G.711u	G.711u
Audio input	1-ch, RCA [2.0 Vp-p, 1 KΩ]	1-ch, RCA [2.0 Vp-p, 1 KΩ]	1-ch, RCA [2.0 Vp-p, 1 KΩ]
Two-way audio in	1-ch, RCA [2.0 Vp-p, 1 KΩ] (using the audio input)	1-ch, RCA [2.0 Vp-p, 1 KΩ] (using the first audio input)	1-ch, RCA [2.0 Vp-p, 1 KΩ] (using the audio input)
HDMI/VGA output	1-ch, 2K [2560 × 1440]/60Hz, 1920 × 1080/60Hz, 1280 × 1024/60Hz, 1280 × 720/60Hz, 1024 × 768/60Hz HDMI/VGA simultaneous output	1-ch, 1920 × 1080/60Hz, 1280 × 1024/60Hz, 1280 × 720/60Hz, 1024 × 768/60Hz, HDMI/VGA simultaneous output	1-ch, 2K [2560 × 1440]/60Hz, 1920 × 1080/60Hz, 1280 × 1024/60Hz, 1280 × 720/60Hz, 1024 × 768/60Hz HDMI/VGA simultaneous output
CVBS output	1-ch, BNC [1.0 Vp-p, 75 Ω], resolution: PAL: 704 × 576, NTSC: 704 × 480	1-ch, BNC [1.0 Vp-p, 75 Ω], resolution: PAL: 704 × 576, NTSC: 704 × 480	1-ch, BNC [1.0 Vp-p, 75 Ω], resolution: PAL: 704 × 576, NTSC: 704 × 480
Encoding resolution	Main stream: 8 MP@8 fps/5 MP@12 fps/4 MP@15 fps/3 MP@18 fps/1080p/720p/WD1/4CIF/VGA/CIF@25 fps (P)/30 fps (N)	When 1080p Lite mode enabled: 4 MP lite/3 MP@15 fps; 1080p lite/720p lite/VGA/WD1/4CIF/CIF@25 fps (P)/30 fps (N)	Main stream: 8 MP@8 fps/5 MP@12 fps/4 MP@15 fps/3 MP@18 fps/1080p/720p/WD1/4CIF/VGA/CIF@25 fps (P)/30 fps (N)
Video bitrate	32 Kbps to 10 Mbps	32 Kbps to 6 Mbps	32 Kbps to 10 Mbps
Audio output	1-ch, RCA [Linear, 1 KΩ]	1-ch, RCA [Linear, 1 KΩ]	1-ch, RCA [Linear, 1 KΩ]
Audio bitrate	64 Kbps	64 Kbps	64 Kbps
Synchronous playback	4-ch	8-ch	8-ch
SATA	1 SATA interface	1 SATA interface	1 SATA interface
Capacity	Up to 10 TB capacity for each disk	Up to 10 TB capacity for each disk	Up to 10 TB capacity for each disk
Network interface	1, RJ45 10M/100M self-adaptive Ethernet interface	1, RJ45 10M/100M self-adaptive Ethernet interface	1, RJ45 10M/100M self-adaptive Ethernet interface
USB port	Front panel: 1 × USB 2.0 Rear panel: 1 × USB 2.0	Front panel: 1 × USB 2.0; Rear panel: 1 × USB 2.0	Front panel: 1 × USB 2.0 Rear panel: 1 × USB 3.0
Alarm in/out	N/A	N/A	N/A
Power supply	12 VDC	12 VDC	12 VDC
Working temperature	-10 °C to +55 °C [+14 °F to +131 °F]	-10 °C to 55 °C [14 °F to 131 °F]	-10 °C to +55 °C [+14 °F to +131 °F]
Working humidity	10% to 90%	10% to 90%	10% to 90%
Dimensions(W × D × H)	315 × 242 × 45 mm [12.4 × 9.5 × 1.8 inch]	315 × 242 × 45 mm [12.4 × 9.5 × 1.8 inch]	315 × 242 × 45 mm [12.4 × 9.5 × 1.8 inch]

Short Description	iDS-7200HUHI-M2/S SERIES TURBO ACUSENSE DVR	iDS-7200HQHI-M1/S SERIES TURBO ACUSENSE DVR	iDS-7200HQHI-M2/S SERIES TURBO ACUSENSE DVR
Model	iDS-7208HUHI-M2/S/A	iDS-7216HQHI-M1/S	iDS-7216HQHI-M2/S
Video compression	H.265 Pro+/H.265 Pro/H.265/H.264+/H.264	H.265 Pro+/H.265 Pro/H.265/H.264+/H.264	H.265 Pro+/H.265 Pro/H.265/H.264+/H.264
Analog video input		16-ch	16-ch
HD-TVI video input	8 MP, 5 MP, 4 MP, 3 MP, 1080p@30 fps, 1080p@25 fps, 720p@60 fps, 720p@50 fps, 720p@30 fps, 720p@25 fps	3 MP, 1080p30, 1080p@25 fps, 720p@60 fps, 720p@50 fps, 720p@30 fps, 720p@25 fps	4 MP lite/3 MP@15 fps; 1080p lite/720p lite/VGA/WD1/4CIF/CIF@25 fps (P)/30 fps (N)
IP video input	4-ch (up to 12-ch) IP enhanced mode on: 8-ch (up to 16-ch), each up to 4 Mbps	2-ch (up to 18-ch), Up to 6 MP resolution Support H.265+/H.265/H.264+/H.264 IP cameras	2-ch (up to 18-ch) IP enhanced mode on: 8-ch (up to 24-ch), each up to 4 Mbps
Audio compression	G.711u	G.711u	G.711u
Audio input	1-ch, RCA [2.0 Vp-p, 1 KΩ]	1-ch, RCA [2.0 Vp-p, 1 KΩ]	1-ch, RCA [2.0 Vp-p, 1 KΩ]
Two-way audio in	1-ch, RCA [2.0 Vp-p, 1 KΩ] (using the audio input)	1-ch, RCA [2.0 Vp-p, 1 KΩ] (using the first audio input)	1-ch, RCA [2.0 Vp-p, 1 KΩ] (using the first audio input)
HDMI/VGA output	1-ch, 4K [3840 × 2160]/30Hz, 2K [2560 × 1440]/60Hz, 1920 × 1080/60Hz, 1280 × 1024/60Hz, 1280 × 720/60Hz, 1024 × 768/60Hz HDMI/VGA simultaneous output	1-ch, 1920 × 1080/60Hz, 1280 × 1024/60Hz, 1280 × 720/60Hz, 1024 × 768/60Hz, HDMI/VGA simultaneous output	1-ch, 1920 × 1080/60Hz, 1280 × 1024/60Hz, 1280 × 720/60Hz, 1024 × 768/60Hz, HDMI/VGA simultaneous output
CVBS output	1-ch, BNC [1.0 Vp-p, 75 Ω], resolution: PAL: 704 × 576, NTSC: 704 × 480	1-ch, BNC [1.0 Vp-p, 75 Ω], resolution: PAL: 704 × 576, NTSC: 704 × 480	1-ch, BNC [1.0 Vp-p, 75 Ω], resolution: PAL: 704 × 576, NTSC: 704 × 480 1-ch, BNC [1.0 Vp-p, 75 Ω], resolution: PAL: 704 × 576, NTSC: 704 × 480
Encoding resolution	Main stream: 8 MP@8 fps/5 MP@12 fps/4 MP@15 fps/3 MP@18 fps/1080p/720p/WD1/4CIF/VGA/CIF@25 fps (P)/30 fps (N)	When 1080p Lite mode enabled: 4 MP lite/3 MP@15 fps; 1080p lite/720p lite/VGA/WD1/4CIF/CIF@25 fps (P)/30 fps (N)	For 4 MP stream access: 4 MP lite@15 fps; 1080p lite/720p/WD1/4CIF/VGA/CIF@25 fps (P)/30 fps (N) For 3 MP stream access: 3 MP/1080p/720p/VGA/WD1/4CIF/CIF@15 fps For 1080p stream access: 1080p/720p@15 fps; VGA/WD1/4CIF/CIF@25 fps (P)/30 fps (N) For 720p stream access: 720p/VGA/WD1/4CIF/CIF@25 fps (P)/30 fps (N) When 1080p Lite mode enabled: 4 MP lite/3 MP@15 fps; 1080p lite/720p lite/VGA/WD1/4CIF/CIF@25 fps (P)/30 fps (N)
Video bitrate	32 Kbps to 10 Mbps	32 Kbps to 6 Mbps	32 Kbps to 6 Mbps
Audio output	1-ch, RCA [Linear, 1 KΩ]	1-ch, RCA [Linear, 1 KΩ]	1-ch, RCA [Linear, 1 KΩ]
Audio bitrate	64 Kbps	64 Kbps	64 Kbps
Synchronous playback	8-ch	16-ch	16-ch
SATA	2 SATA interfaces	1 SATA interface	2 SATA interfaces
Capacity	Up to 10 TB capacity for each disk	Up to 10 TB capacity for each disk	Up to 10 TB capacity for each disk
Network interface	1, RJ45 10M/100M/1000M self-adaptive Ethernet interface	1, RJ45 10M/100M/1000M self-adaptive Ethernet interface	1, RJ45 10M/100M/1000M self-adaptive Ethernet interface
USB port	Front panel: 1 × USB 2.0 Rear panel: 1 × USB 3.0	Front panel: 1 × USB 2.0; Rear panel: 1 × USB 3.0	Front panel: 1 × USB 2.0; Rear panel: 1 × USB 3.0
Alarm in/out	N/A	N/A	N/A
Power supply	12 VDC	12 VDC	12 VDC
Working temperature	-10 °C to +55 °C [+14 °F to +131 °F]	-10 °C to 55 °C [14 °F to 131 °F]	-10 °C to 55 °C [14 °F to 131 °F]
Working humidity	10% to 90%	10% to 90%	10% to 90%
Dimensions(W × D × H)	380 × 320 × 48 mm [15.0 × 12.6 × 1.9 inch]	315 × 242 × 45 mm [12.4 × 9.5 × 1.8 inch]	380 × 320 × 48 mm [15.0 × 12.6 × 1.9 inch]

MINI 1U CHASSIS



Short Description	DS-7100HQHI-K1 SERIESTURBO HD DVR	DS-7108HQHI-K1 SERIESTURBO HD DVR
Model	DS-7104HQHI-K1(S)	DS-7108HQHI-K1(S)
Video compression	H.265 Pro+/H.265 Pro/H.265/H.264+/H.264	H.265 Pro+/H.265 Pro/H.265/H.264+/H.264
Analog video input	4-ch	8-ch
HD-TVI video input	4 MP, 3 MP, 1080p25, 1080p30, 720p25, 720p30, 720p50, 720p60	4 MP, 3 MP, 1080p25, 1080p30, 720p25, 720p30, 720p50, 720p60
IP video input	2-ch (up to 6-ch)	4-ch (up to 12-ch)
Audio compression	G.711u	G.711u
Audio input	1-ch, RCA (2.0 Vp-p, 1 KΩ)	1-ch, RCA (2.0 Vp-p, 1 KΩ)
Two-way audio in	1-ch, RCA (2.0 Vp-p, 1 KΩ) (using the first audio input)	1-ch, RCA (2.0 Vp-p, 1 KΩ) (using the first audio input)
HDMI/VGA output		
CVBS output	1-ch, 1920 × 1080/60Hz, 1280 × 1024/60Hz, 1280 × 720/60Hz, 1024 × 768/60Hz	1-ch, 1920 × 1080/60Hz, 1280 × 1024/60Hz, 1280 × 720/60Hz, 1024 × 768/60Hz
Encoding resolution	When 1080p Lite mode is not enabled: 4 MP lite/3 MP/1080p/720p/VGA/WD1/4CIF/CIF;When 1080p Lite mode is enabled: 4 MP lite/3 MP/1080p lite/720p lite/VGA/WD1/4CIF/CIF	When 1080p Lite mode is not enabled: 4 MP lite/3 MP/1080p/720p/VGA/WD1/4CIF/CIF;When 1080p Lite mode is enabled: 4 MP lite/3 MP/1080p lite/720p lite/VGA/WD1/4CIF/CIF
Video bitrate	32 Kbps to 6 Mbps	32 Kbps to 6 Mbps
Audio output	1-ch, RCA (Linear, 1 KΩ)	1-ch, RCA (Linear, 1 KΩ)
Audio bitrate	64 Kbps	64 Kbps
Synchronous playback	4-ch	8-ch
SATA	1 SATA interface	1 SATA interface
Capacity	Up to 6 TB capacity for each disk	Up to 6 TB capacity for each disk
Network interface	1, RJ45 10M/100M self-adaptive Ethernet interface	1, RJ45 10M/100M self-adaptive Ethernet interface
USB port	Real panel: 2 × USB 2.0	Real panel: 2 × USB 2.0
Alarm in/out	N/A	N/A
Power supply	12 VDC	12 VDC
Working temperature	-10 °C to +55 °C (+14 °F to +131 °F)	-10 °C to +55 °C (+14 °F to +131 °F)
Working humidity	10% to 90%	10% to 90%
Dimensions(W × D × H)	200 × 200 × 45 mm (7.9 × 7.9 × 1.8 inch)	200 × 200 × 45 mm (7.9 × 7.9 × 1.8 inch)



TAKE TOTAL CONTROL OF ACCESS CONTROL

HIKVISION ACCESS CONTROL

ACCESS CONTROL

Complete, end-to-end solutions – from cameras to access controllers, from alarm relays to IP architecture, from door locks to DVRs, and more – have been meticulously engineered by the world’s largest R&D Development team in the security industry. Hikvision’s development facilities lead the industry in advancing the technology of every essential piece in an Access Control system.

ELEVATOR CONTROLLER



Short Description	Master Elevator Controller
Model	DS-K2210
Processor	32 bit
Capacity	
Uplink Communication Interface	TCP/IP Network Interface and RS-485 Interface
Downlink Communication Interface	Wiegand interface
Storage	Cards information:
Card Capability	20,000
Record Capability	Access control events: 50,000
LED Indicator	Power On: Solid GreenRunning Property: Flashing GreenRunning Exception: Solid RedSerial Port Not Communicating: OffSerial Port Communicating: Solid GreenRelay NC: OffRelay NO: Solid GreenNetwork Disconnected: OffNetwork Cable Connected: Solid Yellow, Flashing GreenNetwork Armed: Solid Yellow, Flashing Green
Built-in Clock	Yes
Accessible Card Reader1	Up to 2 RS-485 Card Readers or 2 Wiegand Card Readers
Accessible Card Reader2	
Input Interface1	1 Panic Button; 1 Fire Alarm Button; 1 Maintenance Button
Input Interface2	
Input Interface3	
Input Interface4	
Output Interface	5 Relay Outputs
Power Supply	12 VDC±15%
Power Dissipation (with Load)	
Working Temperature	-20°C to +65°C
Working Humidity	0% to 90% (Non-Condensing)
Dimensions (L×W×H)	167x105x30mm

ACCESS CONTROLLERS



Short Description	Single-Door Access Controller
Model	DS-K2601
Processor	32-bit
Capacity	16M
Uplink Communication Interface	TCP/IP Network Interface and RS-485 Interface
Downlink Communication Interface	RS-485 and Wiegand (w26/w34)
Storage	Cards information:
Card Capability	100,000 (200,000 expandable)
Record Capability	Access control events : 300,000 (600,000 expandable)
LED Indicator	Power Supply Status, Communication Status, Working Status
Built-in Clock	Yes
Accessible Card Reader1	2 Card Readers (RS485 Interface)
Accessible Card Reader2	2 Card Readers (Wiegand Interface) Connectable
Input Interface1	Alarm Input×4,
Input Interface2	Door Contact×1,
Input Interface3	Exit Button×1,
Input Interface4	Case Input×2, Tamper-proof×1
Output Interface	Door Switch Relay×1, Alarm Relay×1
Power Supply	DC 12V/1A
Power Dissipation (with Load)	≤50W
Working Temperature	-20°C to +65°C
Working Humidity	10% to 90% (Non-Condensing)
Dimensions (L×W×H)	370x345x90mm



Short Description	Double-Door Access Controller	Four-Door Access Controller
Model	DS-K2602	DS-K2604
Processor	32-bit	32-bit
Capacity	16M	16M
Uplink Communication Interface	TCP/IP Network Interface and RS-485 Interface	TCP/IP Network Interface and RS-485 Interface
Downlink Communication Interface	RS-485 and Wiegand (w26/w34)	RS-485 and Wiegand (w26/w34)
Storage	Cards information:	Cards information:
Card Capability	100,000 (200,000 expandable)	100,000 (200,000 expandable)
Record Capability	Access control events : 300,000 (600,000 expandable)	Access control events : 300,000 (600,000 expandable)
LED Indicator	Power Supply Status, Communication Status, Working Status	Power Supply Status, Communication Status, Working Status
Built-in Clock	Yes	Yes
Accessible Card Reader1	4 Card Readers (RS485 Interface)	8 Card Readers (RS485 Interface)
Accessible Card Reader2	4 Card Readers (Wiegand Interface)	4 Card Readers (Wiegand Interface)
Input Interface1	Alarm Input×4,	Alarm Input×4,
Input Interface2	Door Sensor × 2	Door Sensor × 4
Input Interface3	Exit Button × 2	Exit Button × 4
Input Interface4	Case Input × 4, Tamper Alarm × 1	Case Input×8, Tamper Alarm × 1
Output Interface	Door Relay × 2, Alarm Relay × 4	Lock Relay × 4, Alarm Relay × 4
Power Supply	DC 12V/1A	DC 12V/1A
Power Dissipation (with Load)	≤100W	≤100W
Working Temperature	-20°C to +65°C	-20°C to +65°C
Working Humidity	10% to 90% (Non-Condensing)	10% to 90% (Non-Condensing)
Dimensions (L×W×H)	370x345x90mm	370x345x90mm



Short Description	Entry Level Single-Door Access Controller	Entry Level Double-Door Access Controller
Model	DS-K2801	DS-K2802
Processor	32-bit	32-bit
Capacity		
Uplink Communication Interface	TCP/IP Network Interface and RS-485 Interface	TCP/IP Network Interface and RS-485 Interface
Downlink Communication Interface	Wiegand interface	Wiegand interface
Storage	Cards information:	Cards information:
Card Capability	10,000	10,000
Record Capability	Access control events: 50,000	Access control events: 50,000
LED Indicator	Power Supply Status, Communication Status, Abnormal Status	Power Supply Status, Communication Status, Abnormal Status
Built-in Clock	Yes	Yes
Accessible Card Reader1		
Accessible Card Reader2	2 Card Readers (Wiegand Interface) Connectable	4 Card Readers (Wiegand Interface) Connectable
Input Interface1		
Input Interface2	Door Contact×1,	Door Contact×2,
Input Interface3	Exit Button×1,	Exit Button×2,
Input Interface4	Case Input×1	Case Input×2
Output Interface	Door Switch Relay×1, Alarm Relay×1	Door Switch Relay×2, Alarm Relay×2
Power Supply	DC 12V	DC 12V
Power Dissipation (with Load)	≤3.5W (without load)	≤3.5W (without load)
Working Temperature	-20°C to +65°C	-20°C to +65°C
Working Humidity	10% to 90% (Non-Condensing)	10% to 90% (Non-Condensing)
Dimensions (L×W×H)	285x237x69mm	285x237x69mm



ELEVATOR CONTROLLER



Short Description	Entry Level Four-Door Access Controller	Distributed Elevator Controller
Model	DS-K2804	DS-K2M0016A
Processor	32-bit	32 bit
Capacity		
Uplink Communication Interface	TCP/IP Network Interface and RS-485 Interface	RS-485x2
Downlink Communication Interface	Wiegand interface	
Storage	Cards information:	
Card Capability	10,000	
Record Capability	Access control events: 50,000	
LED Indicator	Power Supply Status, Communication Status, Abnormal Status	
Built-in Clock	Yes	
Accessible Card Reader1		
Accessible Card Reader2	4 Card Readers (Wiegand Interface) Connectable	
Input Interface1		Allarm Input x2
Input Interface2	Door Contact×4,	
Input Interface3	Exit Button×4,	
Input Interface4	Case Input×4	
Output Interface	Door Switch Relay×4, Alarm Relay×4	Relay Output x 16
Power Supply	DC 12V	12 VDC±15%
Power Dissipation (with Load)	≤3.5W (without load)	
Working Temperature	-20°C to +65°C	-20°C to +65°C
Working Humidity	10% to 90% (Non-Condensing)	0% to 90% (Non-Condensing)
Dimensions (L×W×H)	285x237x69mm	167x105x30mm

ACCESS TERMINALS



Short Description	IP Fingerprint TSA Terminal	IP Fingerprint TSA Terminal
Model	DS-K1A802EF	DS-K1A802MF
Storage	N/A	N/A
Micro SD Card (Additional)	N/A	N/A
Camera	N/A	N/A
Face Detection	N/A	N/A
Face Recognition Distance		
Face Recognition Accuracy Rate		
1:N Face Recognition Duration		
Valid Cards/ Events	100,000 valid cards, 300,000 events	100,000 valid cards, 300,000 events
Fingerprint Capacity	Up to 3000 Fingerprints	Up to 3000 Fingerprints
Fingerprint Recognition Duration	1:N < 1 s (Max. 3000 Fingerprints)	1:N < 1 s (Max. 3000 Fingerprints)
Fingerprint Recognizer	Optical Fingerprint Recognizer Module	Optical Fingerprint Recognizer Module
Card Reading Mode	EM 125 KHz	Mifare-1 13.56 MHz
Card Reading Distance	≥5 cm	≥5 cm
External Card Reader	N/A	N/A
Communication Mode	TCP/IP, Wi-Fi	TCP/IP, Wi-Fi
USB Interface	USB2.0	USB2.0
Input Interface	N/A	N/A
Output Interface	N/A	N/A
LCD Screen	2.8-inch 320 x 240 LCD-TFT Display Screen	2.8-inch 320 x 240 LCD-TFT Display Screen
LED Indicator	Power/Status (Red/Green)	Power/Status (Red/Green)
Power Supply	12VDC	12VDC
Protection Level	N/A	N/A
Working Temperature	-10° C to 55° C	-10° C to 55° C
Certificate	CE, FCC	CE, FCC
Dimension	140x155x30 mm	140x155x30 mm



Short Description	IP Fingerprint TSA Terminal	IP Fingerprint TSA Terminal
Model	DS-K1A8503EF-B	DS-K1A8503MF-B
Storage	N/A	N/A
Micro SD Card (Additional)	N/A	N/A
Camera	N/A	N/A
Face Detection	N/A	N/A
Face Recognition Distance		
Face Recognition Accuracy Rate		
1:N Face Recognition Duration		
Valid Cards/ Events	1000 valid cards, 10,0000 events	1000 valid cards, 10,0000 events
Fingerprint Capacity	1000fingerprint	1000fingerprint
Fingerprint Recognition Duration	1S	1S
Fingerprint Recognizer	N/A	N/A
Card Reading Mode	EM 125 KHz	Mifare-1 13.56 MHz
Card Reading Distance	≥ 5cm	≥ 5cm
External Card Reader	N/A	N/A
Communication Mode	TCP/IP ,Ehome	TCP/IP ,Ehome
USB Interface	USB2.0	USB2.0
Input Interface	Exit Button×1, Door Contact×1, Doorbell Button×1	Exit Button×1, Door Contact×1, Doorbell Button×1
Output Interface	Relay (lock output) × 1, doorbell output × 1	
LCD Screen	2.4-inch display screen	2.4-inch display screen
LED Indicator	N/A	N/A
Power Supply		
Protection Level		
Working Temperature	-10°C to 55 °C	-10°C to 55 °C
Certificate	CE, FCC	CE, FCC
Dimension	140 mm × 155 mm × 30mm (5.51" × 6.01" × 1.18")	140 mm × 155 mm × 30mm (5.51" × 6.01" × 1.18")



Short Description	IP Access Control Terminal	IP Access Control Terminal
Model	DS-K1T105E-C	DS-K1T105M-C
Storage	256M Storage,	256M Storage,
Micro SD Card (Additional)	Max.32G, Built-in Micro SD Card	Max.32G, Built-in Micro SD Card
Camera	2 MP	2 MP
Face Detection	Yes	Yes
Face Recognition Distance		
Face Recognition Accuracy Rate		
1:N Face Recognition Duration		
Valid Cards/ Events	100,000 valid cards, 300,000 events	100,000 valid cards, 300,000 events
Fingerprint Capacity	N/A	N/A
Fingerprint Recognition Duration	N/A	N/A
Fingerprint Recognizer	N/A	N/A
Card Reading Mode	EM 125 KHz	Mifare-1 13.56 MHz
Card Reading Distance	≥5 cm	≥5 cm
External Card Reader	Standard Wiegand26/34 and Hikvision RS-485 reader	Standard Wiegand26/34 and Hikvision RS-485 reader
Communication Mode	TCP/IP, WIFI, RS-485, and Wiegand input/output 26/34 (under card reader mode only)	TCP/IP, WIFI, RS-485, and Wiegand input/output 26/34 (under card reader mode only)
USB Interface	USB2.0	USB2.0
Input Interface	Exit Button×1, Door Contact×1, Alarm×2, Doorbell Button×1	Exit Button×1, Door Contact×1, Alarm×2, Doorbell Button×1
Output Interface	Relay×1, Doorbell×1	Relay×1, Doorbell×1
LCD Screen	320×240 LCD-TFT Display Screen	320×240 LCD-TFT Display Screen
LED Indicator	Power/ Communication	Power/ Communication
Power Supply	12VDC	12VDC
Protection Level	N/A	N/A
Working Temperature	-20°C to 65°C	-20°C to 65°C
Certificate	CE, FCC	CE, FCC
Dimension	122×82×23mm	122×82×23mm



Short Description	IP Fingerprint Access Control Terminal	IP Fingerprint Access Control Terminal
Model	DS-K1T201EF-C	DS-K1T201MF-C
Storage	256M Storage	256M Storage
Micro SD Card (Additional)	Max.32G, Built-in Micro SD Card	Max.32G, Built-in Micro SD Card
Camera	2 MP	2 MP
Face Detection	Yes	Yes
Face Recognition Distance		
Face Recognition Accuracy Rate		
1:N Face Recognition Duration		
Valid Cards/ Events	100,000 valid cards, 300,000 events	100,000 valid cards, 300,000 events
Fingerprint Capacity	Max. 4750 Users (Two Local Collected Fingerprint Templates for Each, Person, 9500 Fingerprints in Total)	Max. 4750 Users (Two Local Collected Fingerprint Templates for Each, Person, 9500 Fingerprints in Total)
Fingerprint Recognition Duration	1:1≤1s, 1:1000≤1s	1:1≤1s, 1:1000≤1s
Fingerprint Recognizer	Optical Fingerprint Recognizer Module	Optical Fingerprint Recognizer Module
Card Reading Mode	EM 125 KHz	Mifare-1 13.56 MHz
Card Reading Distance	≤ 5 cm	≤ 5 cm
External Card Reader	Standard Wiegand26/34 and Hikvision RS-485 reader	Standard Wiegand26/34 and Hikvision RS-485 reader
Communication Mode	TCP/IP, WIFI, RS-485, and Wiegand input/output 26/34 (under card reader mode only)	TCP/IP, WIFI, RS-485, and Wiegand input/output 26/34 (under card reader mode only)
USB Interface	USB2.0	USB2.0
Input Interface	Exit Button×1, Door Contact×1, Alarm×2, Doorbell Button×1	Exit Button×1, Door Contact×1, Alarm×2, Doorbell Button×1
Output Interface	Relay×1, Doorbell×1	Relay×1, Doorbell×1
LCD Screen	320×240 LCD-TFT Display Screen	320×240 LCD-TFT Display Screen
LED Indicator	Power/ Communication	Power/ Communication
Power Supply	12VDC	12VDC
Protection Level	N/A	N/A
Working Temperature	-20°C to 65°C	-20°C to 65°C
Certificate	CE, FCC	CE, FCC
Dimension	122×142×27mm	122×142×27mm



Short Description	IP Video Access Control Terminal	IP Video Access Control Terminal
Model	DS-K1T500S	DS-K1T501SF
Storage	N/A	N/A
Micro SD Card (Additional)	Max. 32G, Built-in Micro SD Card	Max. 32G, Built-in Micro SD Card
Camera	2MP/1080P, IR Light, 140° angle, Record on NVR	2MP/1080P, IR Light, Record on NVR
Face Detection	Yes	Yes
Face Recognition Distance		
Face Recognition Accuracy Rate		
1:N Face Recognition Duration		
Valid Cards/ Events	50,000 valid cards, 200,000 events	50,000 valid cards, 200,000 events
Fingerprint Capacity	N/A	3000
Fingerprint Recognition Duration	N/A	≤ 1s
Fingerprint Recognizer	N/A	Optical Fingerprint Recognition Module
Card Reading Mode	Mifare-1 13.56 MHz	Mifare-1 13.56 MHz
Card Reading Distance	≤ 5 cm	≤ 5 cm
External Card Reader	Standard Wiegand26/34 and Hikvision RS-485 reader	Standard Wiegand26/34 and Hikvision RS-485 reader
Communication Mode	TCP/IP, RS-485, and Wiegand input/output 26/34 (under card reader mode only)	TCP/IP, RS-485, and Wiegand input/output 26/34 (under card reader mode only)
USB Interface	N/A	N/A
Input Interface	Exit Button×1, Door Contact×1, Alarm×2, Doorbell Button×1	Exit Button×1, Door Contact×1, Alarm×2, Doorbell Button×1
Output Interface	Relay×1, Doorbell×1	Relay×1, Doorbell×1
LCD Screen	N/A	N/A
LED Indicator	Power/Status	Power/Status
Power Supply	12VDC	
Protection Level	IP65	IP65
Working Temperature	-40°C to 60°C	-40°C to 60°C
Certificate	CE, FCC	CE, FCC
Dimension	218mm × 78mm × 41mm	218mm × 78mm × 41mm



Short Description	Face Recognition Terminal	Face Recognition Terminal
Model	DS-K1T606M	DS-K1T606MF
Storage	Yes	Yes
Micro SD Card (Additional)	USB	USB
Camera	2 MP; WDR; Wide-Angle Lens	2 MP; WDR; Wide-Angle Lens
Face Detection	3000	3000
Face Recognition Distance	0.3 m to 1 m	0.3 m to 1 m
Face Recognition Accuracy Rate	≥ 99%	≥ 99%
1:N Face Recognition Duration	≤ 1s/Person	≤ 1s/Person
Valid Cards/ Events	5000 valid cards, 100,000 events	5000 valid cards, 100,000 events
Fingerprint Capacity	N/A	5000
Fingerprint Recognition Duration	1:N Recognition Duration (Up to 5000 fingerprints) < 1s	1:N Recognition Duration (Up to 5000 fingerprints) < 1s
Fingerprint Recognizer	N/A	Optical Fingerprint Recognizer Module
Card Reading Mode	Mifare-1 13.56 MHz	Mifare-1 13.56 MHz
Card Reading Distance	≥ 5cm	≥ 5cm
External Card Reader	Standard Wiegand26/34 and Hikvision RS-485 reader	Standard Wiegand26/34 and Hikvision RS-485 reader
Communication Mode	10/100 Mbps Self-Adaptive Network Interface; Wi-Fi	10/100 Mbps Self-Adaptive Network Interface; Wi-Fi
USB Interface	USB 2.0	USB 2.0
Input Interface	RS-485 × 1, Wiegand × 1, USB × 1, Lock × 1, Door Bell × 1, Exit Button × 1, Tamper × 1, Alarm Input × 2, Alarm Output × 1, Door Lock × 1	RS-485 × 1, Wiegand × 1, USB × 1, Lock × 1, Door Bell × 1, Exit Button × 1, Tamper × 1, Alarm Input × 2, Alarm Output × 1, Door Lock × 1
Output Interface	Lock × 1, Alarm Output × 1	Lock × 1, Alarm Output × 1
LCD Screen	5-inch LCD Touch Screen; Resolution: 800 × 480	5-inch LCD Touch Screen; Resolution: 800 × 480
LED Indicator	Communication/ Status	Communication/ Status
Power Supply	12 VDC	12 VDC
Protection Level	Indoor; Outdoor	Indoor; Outdoor
Working Temperature	-20°C to 50°C	-20°C to 50°C
Certificate	CE, FCC	CE, FCC
Dimension	281.5 mm × 113 mm × 45 mm	281.5 mm × 113 mm × 45 mm



Short Description	Face Recognition Terminal	Face Recognition Terminal
Model	DS-K1T607TMFW	DS-K1T671M
Storage	Yes	Yes
Micro SD Card (Additional)	USB	USB
Camera	2 MP Dual-Lens Camera; 1080p; Auto-Focus;	2 MP Dual-Lens Camera; 1080p; Auto-Focus;
Face Detection		
Face Recognition Distance	0.3 m to 1 m	0.3 m to 1 m
Face Recognition Accuracy Rate	≥ 99%	≥ 99%
1:N Face Recognition Duration	≤ 0.5s/Person	≤ 0.5s/Person
Valid Cards/ Events	50,000 valid cards, 50,000 events	50,000 valid cards, 50,000 events
Fingerprint Capacity	5000	N/A
Fingerprint Recognition Duration	< 1s	< 1s
Fingerprint Recognizer	Optical Fingerprint Recognizer Module	Optical Fingerprint Recognizer Module
Card Reading Mode	Mifare-1 13.56 MHz	Mifare-1 13.56 MHz
Card Reading Distance	≥ 5cm	≥ 5cm
External Card Reader	Standard Wiegand26/34 and Hikvision RS-485 reader	Standard Wiegand26/34 and Hikvision RS-485 reader
Communication Mode	10/100/1000 Mbps Self-Adaptive Network Interface, wifi	10/100/1000 Mbps Self-Adaptive Network Interface, wifi
USB Interface	USB 2.0	USB 2.0
Input Interface	RS-485 × 1, Wiegand × 1, USB × 1, Lock × 1, Door Magnetic Sensor × 1, Alarm Input × 2, Alarm Output × 1, Tamper × 1, Exit Button × 1	RS-485 × 1, Wiegand × 1, USB × 1, Lock × 1, Door Magnetic Sensor × 1, Alarm Input × 2, Alarm Output × 1, Tamper × 1, Exit Button × 1
Output Interface	Lock × 1, Alarm Output × 1	Lock × 1, Alarm Output × 1
LCD Screen	7-inch LCD Touch Screen; Resolution: 1280 × 600, 16:9	7-inch LCD Touch Screen; Resolution: 1280 × 600, 16:9
LED Indicator		
Power Supply	12 VDC	12 VDC
Protection Level	Indoor;	Indoor;
Working Temperature	-20°C to +65°C	-20°C to +65°C
Certificate	CE, FCC	CE, FCC
Dimension		



Short Description	IP Access Control & TSA Terminal	IP Access Control & TSA Terminal
Model	DS-K1T8003EF	DS-K1T8003MF
Storage	N/A	N/A
Micro SD Card (Additional)	N/A	N/A
Camera	N/A	N/A
Face Detection	N/A	N/A
Face Recognition Distance		
Face Recognition Accuracy Rate		
1:N Face Recognition Duration		
Valid Cards/ Events	1000 valid cards, 10,0000 events	1000 valid cards, 10,0000 events
Fingerprint Capacity	1000fingerprint	1000fingerprint
Fingerprint Recognition Duration	1S	1S
Fingerprint Recognizer	N/A	N/A
Card Reading Mode	EM 125 KHz	Mifare-1 13.56 MHz
Card Reading Distance	≥ 5cm	≥ 5cm
External Card Reader	N/A	N/A
Communication Mode	TCP/IP ,Ehome	TCP/IP ,Ehome
USB Interface	USB2.0	USB2.0
Input Interface	Exit Button×1, Door Contact×1, Doorbell Button×1	Exit Button×1, Door Contact×1, Doorbell Button×1
Output Interface	Relay (lock output) × 1, doorbell output × 1	Relay (lock output) × 1, doorbell output × 1
LCD Screen	2.4-inch display screen	2.4-inch display screen
LED Indicator	N/A	N/A
Power Supply	12V DC	12V DC
Protection Level	N/A	N/A
Working Temperature	`-10°C to 55 °C	`-10°C to 55 °C
Certificate	CE, FCC	CE, FCC
Dimension	140 mm × 155 mm × 30mm (5.51" × 6.01" × 1.18")	140 mm × 155 mm × 30mm (5.51" × 6.01" × 1.18")



Short Description	IP Fingerprint Access Control Terminal	IP Fingerprint Access Control Terminal
Model	DS-K1T804EF	DS-K1T804MF
Storage	N/A	N/A
Micro SD Card (Additional)	N/A	N/A
Camera	N/A	N/A
Face Detection	N/A	N/A
Face Recognition Distance		
Face Recognition Accuracy Rate		
1:N Face Recognition Duration		
Valid Cards/ Events	100,000 valid cards, 300,000 events	100,000 valid cards, 300,000 events
Fingerprint Capacity	Up to 3000 Fingerprints	Up to 3000 Fingerprints
Fingerprint Recognition Duration	1:N Recognition Duration (Up to 3000 fingerprints) < 1s	1:N Recognition Duration (Up to 3000 fingerprints) < 1s
Fingerprint Recognizer	Optical Fingerprint Recognizer Module	Optical Fingerprint Recognizer Module
Card Reading Mode	EM 125 KHz	Mifare-1 13.56 MHz
Card Reading Distance	≥5 cm	≥5 cm
External Card Reader	Standard Wiegand 26/34 reader	Standard Wiegand 26/34 reader
Communication Mode	TCP/IP, Wi-Fi, RS-485 (For Secure Door Control Unit), Wiegand input/output (W26/34)	TCP/IP, Wi-Fi, RS-485 (For Secure Door Control Unit), Wiegand input/output (W26/34)
USB Interface	USB 2.0	USB 2.0
Input Interface	Exit Button×1, Door Contact×1, Alarm×2, Doorbell Button×1	Exit Button×1, Door Contact×1, Alarm×2, Doorbell Button×1
Output Interface	Relay×1 Alarm×1, Doorbell×1	Relay×1 Alarm×1, Doorbell×1
LCD Screen	2.4-inch (320×240 LCD-TFT Display Screen)	2.4-inch (320×240 LCD-TFT Display Screen)
LED Indicator	Power/Status (Red/Green), Key Back Light(White)	Power/Status (Red/Green), Key Back Light(White)
Power Supply	DC 12V	DC 12V
Protection Level	IP42	IP42
Working Temperature	-10° C to 55° C	-10° C to 55° C
Certificate	CE, FCC	CE, FCC
Dimension	205×76.5×37 mm	205×76.5×37 mm



Short Description	Fingerprint Module
Model	DS-KAB671F
Storage	
Micro SD Card (Additional)	
Camera	FingerPrint for DS-K1T607PMW & DS-K1T607TMW
Face Detection	
Face Recognition Distance	
Face Recognition Accuracy Rate	
1:N Face Recognition Duration	
Valid Cards/ Events	
Fingerprint Capacity	
Fingerprint Recognition Duration	
Fingerprint Recognizer	
Card Reading Mode	
Card Reading Distance	
External Card Reader	
Communication Mode	
USB Interface	
Input Interface	
Output Interface	
LCD Screen	
LED Indicator	
Power Supply	
Protection Level	Indoor;
Working Temperature	-20°C to +65°C
Certificate	CE, FCC
Dimension	

PROXIMITY CARD READERS



Short Description	Vandal-proof Card Reader	Vandal-proof Card Reader	Card Reader
Model	DS-K1104M	DS-K1104MK	DS-K1107M
Power Supply	12V DC	12V DC	12V DC
Power Consumption	≤500mA	≤500mA	≤2W
Processor	32-bit	32-bit	32-bit
Radio Frequency Standard	N/A	N/A	ISO 14443-A
Reading Frequency	Mifare-1 13.56 MHz	Mifare-1 13.56 MHz	Mifare-1 13.65 MHz
Reading Range	30 to 50mm	30 to 50mm	≥50mm
ID Settings	Via DIP Switch on the Main Board	Via DIP Switch on the Main Board	Via DIP Switch on the Main Board
Communication Interface	RS-485/Wiegand (W26/W34 protocol)	RS-485/Wiegand (W26/W34 protocol)	RS-485 / Wiegand (DIP Switch)
Audio Alert	Buzzer	Buzzer	Buzzer
Keypad	N/A	Keypad with 12 Keys (0 to 9, *, #)	N/A
LED Indicator	Power Indicator; Status LED Indicator	Power Indicator; Status LED Indicator	Power Indicator; Status LED Indicator
Tamper-Proof	Tampering Alarm	Tampering Alarm	Tampering Alarm
Working Temperature	-40°C to +70°C	-40°C to +70°C	-20°C to +65°C
Working Humidity	10% to 90% (Non Condensing)	10% to 90% (Non Condensing)	10% to 90% (Non Condensing)
Protection Level	IP 65 / IK10 Zinc-Alloy	IP 65 / IK10 Zinc-Alloy	IP65
Dimensions	118×76×23mm	118×76×23mm	85.6x86.5x14mm
Mounting Method	Applied for 86 & 120 Gang Box	Applied for 86 & 120 Gang Box	Wall mounting with screws. The Gang Box is not supported.
Certifications	FCC, CE	FCC, CE	FCC, CE



Short Description	Card Reader	Card Reader	Card Reader
Model	DS-K1107MK	DS-K1108M	DS-K1108MK
Power Supply	12V DC	DC 12V	DC 12V
Power Consumption	≤2W	≤2W	≤2W
Processor	32-bit	32bit	32bit
Radio Frequency Standard	ISO 14443-A	ISO 14443-A	ISO 14443-A
Reading Frequency	Mifare-1 13.65 MHz	Mifare-1 13.56 MHz	Mifare-1 13.56 MHz
Reading Range	≥50mm	30 to 80mm	30 to 80mm
ID Settings	Via DIP Switch on the Main Board	Via DIP Switch on the Main Board	Via DIP Switch on the Main Board
Communication Interface	RS-485 / Wiegand (DIP Switch)	RS485/Wiegand (Set via DIP Switch)	RS485/Wiegand (Set via DIP Switch)
Audio Alert	Buzzer	Buzzer	Buzzer
Keypad	Keypad with 12 Keys (0 to 9, *, #)	N/A	Keypad with 12 Keys (0 to 9, *, #)
LED Indicator	Power Indicator; Status LED Indicator	Power Indicator; Status LED Indicator	Power Indicator; Status LED Indicator
Tamper-Proof	Tampering Alarm	Tampering Alarm	Tampering Alarm
Working Temperature	-20°C to +65°C	-20°C to +65°C	-20°C to +65°C
Working Humidity	10% to 90% (Non Condensing)	10%-90% (No Condensing)	10%-90% (No Condensing)
Protection Level	IP65	IP65	IP65
Dimensions	115×44×22mm	123x88x21mm	123x88x21mm
Mounting Method	Wall mounting with screws. The Gang Box is not supported.	Wall Mounting with/without Gang Box	Wall Mounting with/without Gang Box
Certifications	FCC, CE	FCC, CE	FCC, CE

ENROLMENT STATIONS



MAGNETIC CARDS



Short Description	Card Enrollment Station	Fingerprint Enrollment Station	EM RFID Card
Model	DS-K1F100-D8E	DS-K1F820-F	DS-KEM125
Power Supply			
Power Consumption	200mA		
Processor			64 bit
Radio Frequency Standard			
Reading Frequency			
Reading Range			
ID Settings			
Communication Interface	USB 2.0; Driver Free	USB 2.0	
Audio Alert			
Keypad			
LED Indicator	LED Indicator: Indicates Power and the Communication Status		
Tamper-Proof			
Working Temperature	-20°C to 65°C	-30°C to +70°C	-20 -- + 75
Working Humidity		20% to 80% (Non-Condensing)	
Protection Level			
Dimensions	117x67.5x14.3 mm		85.5mm × 54mm × 0.8mm
Mounting Method			
Certifications			



Short Description	Mifare 1 RFID Card
Model	IC S50
Power Supply	
Power Consumption	
Processor	High security EPROM
Radio Frequency Standard	
Reading Frequency	
Reading Range	
ID Settings	
Communication Interface	
Audio Alert	
Keypad	
LED Indicator	
Tamper-Proof	
Working Temperature	-20 ℃ -- + 75 ℃
Working Humidity	
Protection Level	
Dimensions	85.5mm × 54mm × 0.8mm
Mounting Method	
Certifications	

AUXILLIARY PRODUCTS



Short Description	M1 Non-Contacting IC Card	Touch-less Exit button	Touch-less Exit button	Emergency Break Glass
Model	DS-K7M102-M	DS-K7P03	DS-K7P04	DS-K7PEB
Dimension	26 mm × 50 mm × 4 mm	86×86×25.7mm	90×35×37.7mm	86x86x50mm
Suitable Door		All kinds of narrow doorframes	All kinds of narrow doorframes	Exit door, emergency door
Shell Performance		Aluminum panel	Aluminum panel	Fireproof material, sandblast finished
Weight		0.15kg	0.12kg	0.2kg
Operating Temperature		-20°C to 55°C;	-20°C to 55°C;	-10ℓ to +55ℓ
Operating Humidity		0% to 95%	0% to 95%	0% to 95%

EXIT BUTTONS



2 WIRE GANG BOX



2 WIRE APARTMENT DISTRIBUTOR



2 WIRE VILLA DISTRIBUTOR



2 WIRE POWER ADAPTER



Short Description	2 wire Digital Video/Gang Box		2 wire apartment distributor		2 wire apartment distributor		2 wire Digital Video/Audio Distributor		2 wire power adapter	
Model	DS-KAB8103-IMEX		DS-KAD706		DS-KAD706-S		DS-KAD709		DS-KAW60-2N	
Camera										
Video compression standard										
Resolution										
Audio input										
Audio output										
Exit button										
Door magnetic detection										
Light supplement mode										
Ethernet			10/100 Mbps Self-Adaptive Ethernet		10/100 Mbps Self-Adaptive Ethernet					
Network protocol			TCP/IP		TCP/IP					
Network interface			6 Two-Wire Interface to power device		6 two-wire cascade interfaces					
RS-485										
I/O input										
Power supply			24 VDC, Two-core power supply,		24 VDC, Two-core power supply,		24 VDC		85 to 264 VAC	
Power consumption			≤ 4 W		≤ 4 W		60 W		≤ 60 W	
Working temperature			-10 °C to 55 °C (14 °F to 131 °F)		-10 °C to 55 °C (14 °F to 131 °F)		-10 ℤ to 55 ℤ		-30 °C to 70 °C (-22 °F to 158 °F)	
Working humidity			0% to 95%		0% to 95%		10% to 90%, No Condensing		20% to 95%	
IP protection level										
Dimensions (L x W x H)							112.2 mm x 111 mm x 66 mm		52.5 mm × 90 mm × 54.5 mm	
Display screen										
Display resolution										
App	Support						Support			
panel Material										

2 WIRE APARTMENT DOOR STATION MAIN MODULE



2 WIRE APARTMENT INDOOR STATION



2 WIRE VILLA INDOOR STATION



2 WIRE VILLA INTERCOM



Short Description	2 wire apartment door station main module	2 wire apartment indoor station	2 wire apartment indoor station	2 wire Digital Indoor Station	2 wire Digital Door Station
Model	DS-KD8003-IME2(Europe BV)	DS-KH6320-WTE2(Europe BV)	DS-KH6320-WTE2-W(Europe BV)	DS-KH8340-TCE2/EU-W(-B)	DS-KV8103-IME2/EU
Camera	2MP Colorful Camera,Fish eye (Horizontal: 180°, Vertical:96°),				CMOS Low Illumination 2 MP HD Colorful 155° Fisheye Camera
Video compression standard	H.264	Embedded Linux operation system	Embedded Linux operation system	H.264	H.264
Resolution		1024 × 600	1024 × 600		1920 × 1080
Audio input	Built-in Omnidirectional Microphone	Built-in Omnidirectional Microphone	Built-in Omnidirectional Microphone	Built-in Omnidirectional Microphone	Built-in Omnidirectional Microphone
Audio output	Built-in Loudspeaker	Built-in Loudspeaker	Built-in Loudspeaker	Built-in Loudspeaker	Built-in Loudspeaker
Exit button	Exit Button for Opening the Door				Exit Button for Opening the Door
Door magnetic detection	Detects Door Magnetic Status				Detects Door Magnetic Status
Light supplement mode	IR Supplement				IR Supplement
Ethernet					10/100 Mbps Self-Adaptive Ethernet
Network protocol	TCP/IP, RTSP	TCP/IP, SIP, RTSP	TCP/IP, SIP, RTSP		TCP/IP, RTSP
Network interface	Two-Wire Interface	Two-Wire Interface	Two-Wire Interface	Two-Wire Interface	Two-Wire Interface
RS-485	2 RS-485 Port			1, Half-duplex Interface	1 RS-485 Half-Duplex Port
I/O input	2	2	2		2
Power supply	24 VDC, Two-core power supply,	24 VDC, Two-core power supply,	24 VDC, Two-core power supply,	Powered by DS-KAD709	
Power consumption	≤10W	≤ 6 W	≤ 6 W	Max. 10 W	
Working temperature	-40 °C to 60 °C (-40 °F to 140 °F)	-40 °C to 60 °C (-40 °F to 140 °F)	-40 °C to 60 °C (-40 °F to 140 °F)	-10 °C to +55 °C (14 °F to 131 °F)	
Working humidity	10% to 95%	10% to 95%	10% to 95%	10% to 90%	
IP protection level	IP 65				IP 65
Dimensions (L x W x H)	98mmx99.8mmx43.9mm	200 mm × 140 mm × 15.1 mm (7.9" × 5.5" × 0.6")	200 mm × 140 mm × 15.1 mm (7.9" × 5.5" × 0.6")	196 mm × 133 mm × 25.75 mm	
Display screen		7-inch colorful TFT LCD	7-inch colorful TFT LCD	7-inch Colorful TFT LCD	
Display resolution		1024 × 600	1024 × 600	1024 × 600	
App	Support	Support	Support	Support	
panel Material	Acrylic	Acrylic	Acrylic	Stainless Steel	

ANALOGUE INTERCOM



Short Description	4 Wire Video Intercom Outdoor Station	4 Wire Video Intercom Outdoor Station	4 Wire Video Intercom Indoor Station
Model	DS-KB2411-IM	DS-KB2421-IM	DS-KH2220-S
Camera(door station)	1/4" CMOS, Low Illumination	1/4" CMOS	
Resolution(door station)	720 × 576	720 × 576	
Audio input(door station)	Built-in Omnidirectional Microphone	Built-in Omnidirectional Microphone	
Audio output(door station)	Built-in Loudspeaker	Built-in Loudspeaker	
Audio quality(door station)	Noise Suppression and Echo Cancellation	Noise Suppression and Echo Cancellation	
Light supplement mode(door station)	Photosensitive IR Supplement, IR Range: 2 Meters	Photosensitive IR Supplement, IR Range: 2 Meters	
Four-wire interface(door station)	1 Four-Wire Interface (1-ch Video Input, 1-ch Audio Input, 1-ch Power Supply, 1-ch Grounding)	1 Four-Wire Interface (1-ch Video Input, 1-ch Audio Input/Output, 1-ch Power Supply, 1-ch Grounding)	
I/O output(door station)	1 Relay Output	1 Relay Output	
Material(door station)	Metal	Zinc Alloy	
Power consumption(door station)	Max. 5W	Max. 5W	
Working temperature(door station)	-30° C to +60° C	-30° C to +70° C	
Working humidity(door station)	10% to 90%	10% to 90%	
Dimensions (L × W × H) (door station)	128 mm × 42 mm × 24.8 mm	145mm × 49.2 mm × 26.45 mm	
Display screen(indoor station)			7-Inch Colorful TFT LCD
Display resolution(indoor station)			800 × 480
Operation method(indoor station)			Physical Button
Audio input(indoor station)			Built-in Omnidirectional Microphone
Audio output(indoor station)			Built-in Loudspeaker
Audio quality(indoor station)			Noise Suppression and Echo Cancellation

ANALOG KIT



Short Description	4 Wire Video Intercom Kit - Vandal Resistant	4 Wire Video Intercom Kit - Vandal Resistant	4 Wire Video Intercom Kit	IP Video Intercom Kit	2-wire IP Kit
Model	DS-KIS202	DS-KIS203	DS-KIS204	DS-KIS602	DS-KIS701-B-D
Processor				High-Performance Embedded SOC Processor	High-Performance Embedded SOC Processor
Camera	1/4" CMOS, Low Illumination	1/4" CMOS, Low Illumination	1/4" CMOS, Low Illumination	CMOS Low Illumination 2 MP HD Colorful Camera	CMOS Low Illumination 2 MP HD Colorful 155° Fisheye Camera
Video compression standard				H.264	H.264
Resolution	720 × 576	720 × 576	720 × 576	1920 × 1080	1920 × 1080
Audio input	Built-in Omnidirectional Microphone	Built-in Omnidirectional Microphone	Built-in Omnidirectional Microphone	Built-in Omnidirectional Microphone	Built-in Omnidirectional Microphone
Audio output	Built-in Loudspeaker	Built-in Loudspeaker	Built-in Loudspeaker	Built-in Loudspeaker	Built-in Loudspeaker
Exit button				Exit Button for Opening the Door	Exit Button for Opening the Door
Door magnetic detection				Detects Door Magnetic Status	Detects Door Magnetic Status
Light supplement mode	Photosensitive IR Supplement, IR Range: 2 Meters	Photosensitive IR Supplement, IR Range: 2 Meters	Photosensitive IR Supplement, IR Range: 2 Meters	IR Supplement	IR Supplement
Ethernet				10/100 Mbps Self-Adaptive Ethernet	10/100 Mbps Self-Adaptive Ethernet
Network protocol				TCP/IP, RTSP, ,wifi	TCP/IP, RTSP
Network interface	1 Four-Wire Interface (1-ch Video Input, 1-ch Audio Input, 1-ch Power Supply, 1-ch Grounding)	1 Four-Wire Interface (1-ch Video Input, 1-ch Audio Input, 1-ch Power Supply, 1-ch Grounding)	1 Four-Wire Interface (1-ch Video Input, 1-ch Audio Input, 1-ch Power Supply, 1-ch Grounding)	1 RJ-45 10/100 Mbps Self-Adaptive Ethernet Interface	Two-Wire Interface
RS-485				1 RS-485 Half-Duplex Port	1 RS-485 Half-Duplex Port
I/O input				4	2
Power supply				12 VDC & Standard POE	24 VDC, Power Over Network Cable (DS-KAD709)
Working temperature	-30° C to +60° C	-30° C to +60° C	-30° C to +60° C	-40° C to +60° C [-40° F to 140° F]	-30° C to +60° C [-22° F to 140° F]
Working humidity	10% to 90%	10% to 90%	10% to 90%	10% to 90%	10% to 90%
IP protection level				IP 65	IP 65
Display screen	7-Inch Colorful TFT LCD	7-Inch Colorful TFT LCD	7-Inch Colorful TFT LCD	7-Inch Colorful TFT LCD	7-inch Colorful TFT LCD
Display resolution	800 × 480	800 × 480	800 × 480	1024 × 600	1024 × 600
I/O output(door station)	1 Relay Output	1 Relay Output	1 Relay Output	2 Relay Output	
Power consumption(Door Station/Indoor Station)	Max. 5W	Max. 5W	Max. 5W	Max. 5W	

IP KIT



2-WIRE DIGITAL KIT





2-WIRE IP KIT



Short Description	2-wire IP Kit	2-Wire Video Intercom Kit
Model	DS-KIS701-W-D	DS-KIS702(Europe BV)
Processor	High-Performance Embedded SOC Processor	High-Performance Embedded SOC Processor
Camera	CMOS Low Illumination 2 MP HD Colorful 155° Fisheye Camera	CMOS Low Illumination 2 MP HD Colorful Camera
Video compression standard	H.264	H.264
Resolution	1920 × 1080	1920 × 1080
Audio input	Built-in Omnidirectional Microphone	Built-in Omnidirectional Microphone
Audio output	Built-in Loudspeaker	Built-in Loudspeaker
Exit button	Exit Button for Opening the Door	Exit Button for Opening the Door
Door magnetic detection	Detects Door Magnetic Status	Detects Door Magnetic Status
Light supplement mode	IR Supplement	IR Supplement
Ethernet	10/100 Mbps Self-Adaptive Ethernet	10/100 Mbps Self-Adaptive Ethernet
Network protocol	TCP/IP, RTSP	TCP/IP, RTSP ,wifi
Network interface	Two-Wire Interface	1 RJ-45 10/100 Mbps Self-Adaptive Ethernet Interface
RS-485	1 RS-485 Half-Duplex Port	1 RS-485 Half-Duplex Port
I/O input	2	4
Power supply	24 VDC, Power Over Network Cable (DS-KAD709)	Powered by distributor
Working temperature	-30 °C to +60 °C (-22 °F to 140 °F)	-40° C to +60° C (-40° F to 140° F)
Working humidity	10% to 90%	10% to 90%
IP protection level	IP 65	IP 65
Display screen	7-inch Colorful TFT LCD	7-Inch Colorful TFT LCD
Display resolution	1024 × 600	1024 × 600
I/O output(door station)		2 Relay Output
Power consumption(Door Station/Indoor Station)		Max. 5W

IP INTERCOM



Short Description	Vandal-Resistant Villa Door Station
Model	DS-KB8112-IM
Processor	High-Performance Embedded SOC Processor
Camera	CMOS Low Illumination 1.3 MP HD Digital WDR Colorful Camera with Motion Detection
Video Compression Standards	H.264
Resolution	1280 × 720
Video Frame	25 fps
Display Screen	N/A
Operation Interface	N/A
Audio Input	Built-in Omnidirectional Microphone
Audio Output	Built-in Loudspeaker
Audio Compression Standard	G.711 U
Audio Compression Rate	64 Kbps
Internal Card Reader	N/A
External Card Reader	N/A
Light Supplement Mode	IR Supplement
Ethernet	10M/100M Self-Adaptive Ethernet
Network Protocol	TCP/IP, RTSP, ONVIF, ISAPI, HTTP/S, SMTP
Alarm Input	Door Magnetic Alarm
RS-485	N/A
Wiegand	1
USB	N/A
Material	Zinc Alloy, IK9 Impact Protection
Power Supply	PoE (802.3af Class 3), 12 VDC
Working Temperature	-40° C to +70° C
IP Protection Level	IP66
Dimension	161.9 mm × 74.1 mm × 53.2 mm

IP MODULAR DOOR STATION



Short Description	Camera module	Camera module
Model	DS-KD8003-IME1/EU	DS-KD8003-IME1/Flush/EU
Processor	Embedded MCU Processor	Embedded MCU Processor
Camera	Low Illumination 2 MP HD IR Camera	Low Illumination 2 MP HD IR Camera
Video Compression Standards	H.264	H.264
Resolution	Main Stream: 1920 × 1080Sub Stream: 720 × 480	Main Stream: 1920 × 1080Sub Stream: 720 × 480
Video Frame		
Display Screen		
Operation Interface	Physical Button	Physical Button
Audio Input	Built-in Omnidirectional Microphone	Built-in Omnidirectional Microphone
Audio Output	Built-in Loudspeaker(More than 85 dB within 20 cm)	Built-in Loudspeaker(More than 85 dB within 20 cm)
Audio Compression Standard	G.711 U	G.711 U
Audio Compression Rate	64 Kbps	64 Kbps
Internal Card Reader		
External Card Reader		
Light Supplement Mode	IR Supplement	IR Supplement
Ethernet	10/100 Mbps Self-Adaptive Ethernet	10/100 Mbps Self-Adaptive Ethernet
Network Protocol	TCP/IP, RTSP	TCP/IP, RTSP
Alarm Input		
RS-485	RS485 In *1,out *1	RS485 out *1
Wiegand		
USB		
Material		
Power Supply	12 VDC/PoE (IEEE 802.3af)	12 VDC/PoE (IEEE 802.3af)
Working Temperature	-40° C to +60° C (-40° F to 140° F)	-40° C to +60° C (-40° F to 140° F)
IP Protection Level	IP65	IP65
Dimension	98 mm × 99.8 mm × 43.9 mm (3.86" × 3.93" × 1.73")	98 mm × 99.8 mm × 43.9 mm (3.86" × 3.93" × 1.73")



Short Description	Camera module	Display module
Model	DS-KD8003-IME1/Surface/EU	DS-KD-DIS
Processor	Embedded MCU Processor	
Camera	Low Illumination 2 MP HD IR Camera	
Video Compression Standards	H.264	
Resolution	Main Stream: 1920 × 1080Sub Stream: 720 × 480	
Video Frame		
Display Screen		3.5 inch LCD, 320*480,
Operation Interface	Physical Button	4 Physical Button
Audio Input	Built-in Omnidirectional Microphone	
Audio Output	Built-in Loudspeaker(More than 85 dB within 20 cm)	
Audio Compression Standard	G.711 U	
Audio Compression Rate	64 Kbps	
Internal Card Reader		
External Card Reader		
Light Supplement Mode	IR Supplement	
Ethernet	10/100 Mbps Self-Adaptive Ethernet	
Network Protocol	TCP/IP, RTSP	
Alarm Input		
RS-485	RS485 In *1,out *1	RS485 In *1,out *1,
Wiegand		
USB		
Material		
Power Supply	12 VDC/PoE (IEEE 802.3af)	
Working Temperature	-40° C to +60° C (-40° F to 140° F)	
IP Protection Level	IP65	IP65
Dimension	98 mm × 99.8 mm × 43.9 mm (3.86" × 3.93" × 1.73")	98.21mmx100.21 mm x33.7mm,



Short Description	ID card reader module	Indicator module
Model	DS-KD-E	DS-KD-IN
Processor		Embedded MCU Processor
Camera		
Video Compression Standards		
Resolution		
Video Frame		
Display Screen		
Operation Interface		
Audio Input		
Audio Output		
Audio Compression Standard		
Audio Compression Rate		
Internal Card Reader		
External Card Reader		
Light Supplement Mode		
Ethernet		
Network Protocol		
Alarm Input		
RS-485		RS485 In *1,out *1
Wiegand		
USB		
Material		
Power Supply		
Working Temperature		-40° C to +60° C[-40° F to 140° F]
IP Protection Level		IP65
Dimension		98.5 mm × 100 mm × 33.7 mm (3.87" × 3.95" × 1.33")

Short Description	Nametag module	Control panel module
Model	DS-KD-KK	DS-KD-KP
Processor	Embedded MCU Processor	Embedded MCU Processor
Camera		
Video Compression Standards		
Resolution		
Video Frame		
Display Screen		
Operation Interface	6 Physical Button	12 Physical Button
Audio Input		
Audio Output		
Audio Compression Standard		
Audio Compression Rate		
Internal Card Reader		
External Card Reader		
Light Supplement Mode		
Ethernet		
Network Protocol		
Alarm Input		
RS-485	RS485 In *1,out *1	RS485 In *1,out *1
Wiegand		
USB		
Material		
Power Supply		
Working Temperature	-40° C to +60° C[-40° F to 140° F]	-40° C to +60° C[-40° F to 140° F]
IP Protection Level	IP65	IP65, IK7
Dimension	98.21 mm × 100.21 mm × 33.7 mm (3.87" × 3.95" × 1.33")	98.5 mm × 100 mm × 34.2 mm (3.87" × 3.95" × 1.33")



IP INTERCOM



Metal 1 Button Villa Door Station

Short Description	Mifare card reader module	
Model	DS-KD-M	DS-KV8102-IM
Processor	Embedded MCU Processor	High-Performance Embedded SOC Processor
Camera		CMOS Low Illumination 1.3 MP HD Colorful Camera
Video Compression Standards		H.264
Resolution		1280 × 720
Video Frame		25 fps
Display Screen		N/A
Operation Interface		N/A
Audio Input		Built-in Omnidirectional Microphone
Audio Output		Built-in Loudspeaker
Audio Compression Standard		6.711 U
Audio Compression Rate		64 Kbps
Internal Card Reader	Mifare Card	Built-in Mifare-1 Card Reader
External Card Reader		Door Button for Opening the Door
Light Supplement Mode		IR Supplement
Ethernet		10M/100M Self-Adaptive Ethernet
Network Protocol		TCP/IP, SNMP, SIP, RTSP
Alarm Input		Door Magnetic Alarm; Tampering Alarm
RS-485	RS485 In *1,out *1	1 RS485 Half-Duplex Port
Wiegand		1
USB		N/A
Material		Aluminum alloy
Power Supply		Power Over Network Cable [DS-KAD606 ,DS-KAD612]/12 VDC
Working Temperature	-40° C to +60° C(-40° F to 140° F)	-40° C to +70° C
IP Protection Level	IP65	IP65
Dimension	98.5 mm × 100 mm × 33.7 mm (3.87" × 3.95" × 1.33")	182 mm × 100 mm × 32.5 mm



Metal 2 Button Villa Door Station

Short Description	Metal 2 Button Villa Door Station	Metal 4 Button Villa Door Station
Model	DS-KV8202-IM	DS-KV8402-IM
Processor	High-Performance Embedded SOC Processor	High-Performance Embedded SOC Processor
Camera	CMOS Low Illumination 1.3 MP HD Colorful Camera	CMOS Low Illumination 1.3 MP HD Colorful Camera
Video Compression Standards	H.264	H.264
Resolution	1280 × 720	1280 × 720
Video Frame	25 fps	25 fps
Display Screen	N/A	N/A
Operation Interface	N/A	N/A
Audio Input	Built-in Omnidirectional Microphone	Built-in Omnidirectional Microphone
Audio Output	Built-in Loudspeaker	Built-in Loudspeaker
Audio Compression Standard	6.711 U	6.711 U
Audio Compression Rate	64 Kbps	64 Kbps
Internal Card Reader	Built-in Mifare-1 Card Reader	Built-in Mifare-1 Card Reader
External Card Reader	Door Button for Opening the Door	Door Button for Opening the Door
Light Supplement Mode	IR Supplement	IR Supplement
Ethernet	10M/100M Self-Adaptive Ethernet	10M/100M Self-Adaptive Ethernet
Network Protocol	TCP/IP, SNMP, SIP, RTSP	TCP/IP, SNMP, SIP, RTSP
Alarm Input	Door Magnetic Alarm; Tampering Alarm	Door Magnetic Alarm; Tampering Alarm
RS-485	1 RS485 Half-Duplex Port	1 RS485 Half-Duplex Port
Wiegand	2	4
USB	N/A	N/A
Material	Aluminum alloy	Aluminum alloy
Power Supply	Power Over Network Cable [DS-KAD606 ,DS-KAD612]/12 VDC	Power Over Network Cable [DS-KAD606 ,DS-KAD612]/12 VDC
Working Temperature	-40° C to +70° C	-40° C to +70° C
IP Protection Level	IP65	IP65
Dimension	182 mm × 100 mm × 32.5 mm	182 mm × 100 mm × 32.5 mm



Metal 4 Button Villa Door Station

VALUE INDOOR MONITOR



Short Description	2nd Generation IP Indoor Station	
Model	DS-KH6320-WTE1/EU	DS-KH6320-WTE1-W(Europe BV)
Processor		
Camera		
Resolution		
Video Frame		
Display Screen	7-inch colorful TFT LCD	7-inch colorful TFT LCD, white color
Operation Interface		
Audio Input	Built-in omnidirectional microphone	Built-in omnidirectional microphone
Audio Output	Built-in loudspeaker	Built-in loudspeaker
Audio Compression Standard	G.711 U	G.711 U
Audio Compression Rate	64 Kbps	64 Kbps
Ethernet	10/100 Mbps self-adaptive network	10/100 Mbps self-adaptive network
Network Protocol	TCP/IP, SIP, RTSP, wifi	TCP/IP, SIP, RTSP,wifi
Power Supply	IEEE802.3af, standard PoE	IEEE802.3af, standard PoE
Working Temperature	-10 °C to 55 °C (14 °F to 131 °F)	-10 °C to 55 °C (14 °F to 131 °F)
Operation System	Embedded Linux operation system	Embedded Linux operation system
Display Resolution	1024 × 600	1024 × 600
Operation Method	Capacitive touch screen	Capacitive touch screen
Wireless Internet	Wi-Fi 802.11b/g/n	Wi-Fi 802.11b/g/n
Network Access	1 RJ-45 10/100 Mbps self-adaptive	1 RJ-45 10/100 Mbps self-adaptive
RS485	1	1
I/O Output	2	2
I/O Input		
SD Card	Max to 32 G, SD 2.0 or lower version	Max to 32 G, SD 2.0 or lower version
Power Consumption	≤ 6 W	≤ 6 W
Dimension [L x W x H]	200 mm × 140 mm × 15.1 mm (7.9" × 5.5" × 0.6")	200 mm × 140 mm × 15.1 mm (7.9" × 5.5" × 0.6")

RED DOT INDOOR MONITOR



Short Description	2nd Generation IP Indoor Station	
Model	DS-KH8350-WTE1/EU	DS-KH8520-WTE1/EU
Processor		
Camera		
Resolution		
Video Frame		
Display Screen	7-inch colorful IPS LCD	10.1-inch colorful TFT LCD
Operation Interface		
Audio Input	Built-in omnidirectional microphone	Built-in omnidirectional microphone
Audio Output	Built-in loudspeaker	Built-in loudspeaker
Audio Compression Standard	G.711 U	G.711 U
Audio Compression Rate	64 Kbps	64 Kbps
Ethernet	10/100 Mbps self-adaptive network	10/100 Mbps self-adaptive network
Network Protocol	TCP/IP, SIP, RTSP,wifi	TCP/IP, SIP, RTSP, wifi
Power Supply	IEEE802.3af, standard PoE12 VDC/1 A	IEEE802.3af, standard PoE
Working Temperature	-10 °C to 55°C (14 °F to 131 °F)	-10 °C to 55 °C (14 °F to 131 °F)
Operation System	Embedded Linux operation system	Embedded Linux operation system
Display Resolution	1024 × 600	1024 × 600
Operation Method	Capacitive touch screen, physical button	Capacitive touch screen
Wireless Internet	Wi-Fi 802.11b/g/n	Wi-Fi 802.11b/g/n
Network Access	1 RJ-45 10/100 Mbps self-adaptive	1 RJ-45 10/100 Mbps self-adaptive
RS485	Supported	1
I/O Output	N/A	2
I/O Input		
SD Card	Max to 32G, SD 2.0 or lower version	Max to 32 G, SD 2.0 or lower version
Power Consumption	≤ 7 W	≤ 6 W
Dimension [L x W x H]	180 mm × 140 mm × 22.4 mm (7.09" × 5.51" × 0.88")	254 mm × 166 mm × 14.7 mm (10.0" × 6.5" × 0.58")

ULTRA INDOOR MONITOR



INDOOR STATIONS



Short Description	Master Station
Model	DS-KM8301
Processor	High-Performance Embedded SOC Processor
Camera	CMOS 0.3MP
Resolution	640x480
Video Frame	PAL: 25 fps, NTSC: 30 fps
Display Screen	7-Inch Colorful TFT LCD
Operation Interface	Flattened UI Operation Interface
Audio Input	Built-in Omnidirectional Microphone + External Handset
Audio Output	Built-in Loudspeaker + External Handset
Audio Compression Standard	G.711 U
Audio Compression Rate	64 Kbps
Ethernet	1 RJ45 10M/100M/1000M Self-Adaptive Ethernet
Network Protocol	TCP/IP, SIP, RTSP, wifi
Power Supply	DC 12V
Working Temperature	-10°C to +55°C (14° F to 131° F)
Operation System	Embedded Linux Operation System
Display Resolution	1024 × 600
Operation Method	Capacitive Touch Screen, Touch Key, Physical Button
Wireless Internet	
Network Access	1 RJ45 10M/100M/1000M Self-Adaption Internet Access
RS485	2 RS485 Half-Duplex Ports
I/O Output	2 On-Off Output, 2 Relay Output
I/O Input	4 On-Off Input
SD Card	N/A
Power Consumption	≤10 W
Dimension [L x W x H]	436 mm × 215 mm × 67 mm

INSTALLATION BOX, COVER AND STAND



Short Description	Protective Heavy-Duty Shield	Protective Shield	Indoor Station Table Stand	Gang Box	Table Stand Frame
Model	DS-KAB01	DS-KAB02	DS-KAB21-H	DS-KAB86	DS-KABH6320-T
Compatibility	DS-KV8X02-IM	DS-KV8X02-IM	DS-KH83XX/63XX	All Indoor Stations	KH6320/8520 series indoor station
Housing material	Stainless Steel SUS201	Stainless Steel SUS201	Stainless Steel	PVC	
Inner-shell material	SGCC	SGCC	SGCC		
Working temperature	-30° C to +60° C	-30° C to +60° C	-40° C to +70° C	-5° C to +60° C	-40° C to +60° C [-40° F to 140° F]
Working humidity	10% to 90%	10% to 90%	10% to 90%	10% to 90%	10% to 95%
Dimension [L x W x H]	212×115×75	193×106×75 mm	130.6x98.67x101.62 mm	81×78×50 mm	
Cover Dimension [L x W x D]					122 × 86 × 64 mm [4.80" × 3.39" × 2.52"]
Installation Frame Dimension [L x W x D]					
Gang Box Dimension [L x W x D]					

TABLE STAND FRAME

INSTALLATION FRAME AND GANG BOX



Short Description	Table Stand Frame	Installation Frame and Gang box	Installation Frame and Gang box	Installation Frame and Gang box	Installation Frame and Gang box
Model	DS-KABH8350-T	DS-KD-ACF1(Plastic)	DS-KD-ACF2(Plastic)	DS-KD-ACF3(Plastic)	DS-KD-ACW1
Compatibility	KH8350 series indoor station	1 modules	2 modules	3 modules	1 modules
Housing material					
Inner-shell material					
Working temperature	-40° C to +60° C [-40° F to 140° F]	-40° C to +60° C [-40° F to 140° F]	-40° C to +60° C [-40° F to 140° F]	-40° C to +60° C [-40° F to 140° F]	-40° C to +60° C [-40° F to 140° F]
Working humidity	10% to 95%	10% to 95%	10% to 95%	10% to 95%	10% to 95%
Dimension (L x W x H)					
Cover Dimension (L x W x D)	95 x 83 x 98.9 mm[3.74" x 3.27" x 3.89"]		236 x 124 x 4 mm[9.29" x 4.88" x 0.16"]	337.8 x 124 x 4 mm[13.3" x 4.88" x 0.16"]	
Installation Frame Dimension (L x W x D)		134 x 135 x 56 mm			117 x 107 x 32.7 mm
Gang Box Dimension (L x W x D)		134 x 124 x 4 mm	237 x 134 x 56 mm[9.33" x 5.27" x 2.20"]	338.8 x 134 x 56 mm[13.33" x 5.28" x 2.20"]	117 x 107 x 4 mm



Short Description	Installation Frame and Gang box	Installation Frame and Gang box
Model	DS-KD-ACW2	DS-KD-ACW3
Compatibility	2 modules	3 modules
Housing material		
Inner-shell material		
Working temperature	-40° C to +60° C [-40° F to 140° F]	-40° C to +60° C [-40° F to 140° F]
Working humidity	10% to 95%	10% to 95%
Dimension (L x W x H)		
Cover Dimension (L x W x D)	219 x 107 x 4 mm[8.62" x 4.21" x 0.16"]	320.8 x 107 x 4 mm[12.6" x 4.21" x 0.16"]
Installation Frame Dimension (L x W x D)	219 x 107 x 32.7 mm[8.62" x 4.21" x 1.29"]	320.8 x 107 x 32.7 mm[12.6" x 4.21" x 1.29"]
Gang Box Dimension (L x W x D)		

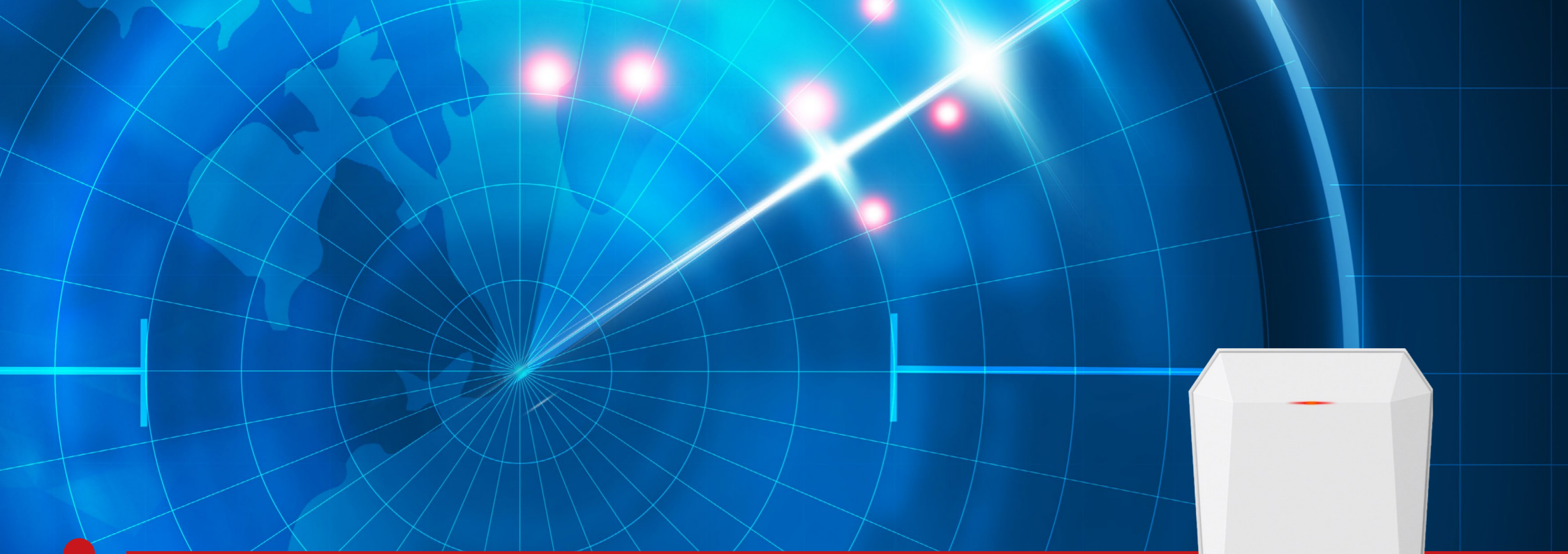

POWERFUL RADAR, NOW AT YOUR SERVICE

SECURITY RADAR

HiKvision Security Radar uses cutting-edge HiKvision technology to accurately pinpoint the location and motion trail of up to 32 potential intruders per radar, even in the harshest weather conditions. Radar solution is perfect for locations that require high security level and stable detection, such as ports, airports and large open industrial areas.



SECURITY RADAR



Short Description	Security Radar	Security Radar
Model	DS-PR1-60	DS-PR120
Modulation	Frequency Modulated Continuous Wave	Frequency Modulated Continuous Wave
Detection range	60 m	Human: 120 m Vehicle: 150 m
Horizontal angle	100°	120°
Range measurement accuracy	± 0.75 m	± 1.5 m
Velocity measurement accuracy	± 0.1 m/s	± 0.1 m/s
Angle measurement accuracy	± 1°	± 1°
Velocity range	- 8.7 to + 8.7 m/s	- 9.8 to + 9.8 m/s
Coverage	3000 m ² (32275.2 ft ²)	15000m ²
Max. target number	32	64
Frequency	24 GHz	24 GHz
Transmission power	< 20 dBm (100mW)	< 20 dBm (100mW)
Zone	8	16
Relay output NO/NC	3-channel : 0.5 A/125 VAC, breakdown voltage : 1 KV 1-channel : 10 A/240 VAC, breakdown voltage : 2.5 KV	3-channel : 5 VDC, 0.5 A/125 VAC, breakdown voltage : 1 KV 1-channel : 12 VDC, 10 A/240 VAC, breakdown voltage : 2.5 KV
Network interface	1 RJ45 10M/100M self-adaptive, PoE	802.3at standard PoE
Power interface	802.3at standard PoE or 12 VDC	802.3at standard PoE or 12 VDC
Reset button	1	1
Operation temperature	-40 °C to 65 °C (-40 °F to 149 °F)	-40 °C to 65 °C (-40 °F to 149 °F)
Operation humidity	10% to 90%	10% to 90%
Dimension (W × H × D)	206 mm × 228 mm × 61 mm (8.11" × 8.98" × 2.40")	206 mm × 228 mm × 61 mm (8.11" × 8.98" × 2.40")
Consumption	< 10 W	< 8 W
Weight	1.84 kg (4.06 lb)	1.9 kg (4.2 lb)
Color	White	White
Installation	Installation height:1.2 m to 4 m (4.72" to 15.7") (Recommended: 2.5 m (9.84"))	Installation height:1.2 m to 4 m (4.72" to 15.7") (Recommended: 2.5 m (9.84"))
Vertical angle	16°	26°



ALARM

Combining Hikvision's market-leading position and world class capabilities with over 30 years of Pyronix intrusion expertise, our range of alarm solutions provide professional installers with innovative and reliable security systems for every requirement.

We fuse intrusion and video, offering Cloud-based intruder alarm systems with cutting-edge technology to redefine security. These platforms generate extensive business opportunities for installers, whilst providing user experiences which are unparalleled.

FLEXIBLE APPLICATION, COMPREHENSIVE PROTECTION

INTRUSION SERIES

Hikvision Alarm offers intruder alarm solutions which combine a deep customer understanding with worldleading technologies. Hikvision provides top-tier intruder products suitable for a range of market segments and vertical applications. These include applications from residential and SOHO (small office/home office) solutions, to commercial, healthcare, seaports, airports, and critical infrastructure applications.



WIRELESS CONTROL PANEL KIT



Short Description	868MHz Wireless control Panel Kits with IC Cards (GPRS Version)	868MHz Wireless Control Panel Kits with keyfob	868MHz Wireless Control Panel Kits with keyfob (GPRS Version)	868MHz Wireless control Panel Kits with IC Cards (3G/4G Version)
Model	DS-PWA32-NGT	DS-PWA32-NK	DS-PWA32-NKG	DS-PWA32-NST
on board LAN/WIFI	Support	Support	Support	Support
GPRS	Yes	No	Yes	No
3G/4G	No	No	No	Yes
Tag Reader	Yes	No	No	Yes
keyfob included	No	Yes	Yes	No

WIRELESS PIR DETECTOR



Short Description	Wireless PIR Detector	Wireless PIR Detector	Wireless PIR Detector
Model	DS-PD2-P10P-W(HT)	DS-PD2-P15C-W(HT)	DS-PD2-P25-W(HT)
Detection Range	10m	15m	25m
Detection Angle	85°	20 °	20°
Mounting Height (m)	1.8m - 2.4m	2.4m-4m	1.8m - 2.4m
Animal immunity (kg)	Up to 24kg		
Transmission frequency	868MHZ FM transceiver	868MHZ FM transceiver	868MHZ FM transceiver
3V lithium battery included	1×CR123A	1×CR123A	1×CR123A
Tamper protection	support	support	support
Signal Strength Indicators (SSI)	support	support	support
Coverage	Volumetric Pet immunity	Curtian	long range
Creep-Zone protection	No	Yes	Yes
Minimal Battery Life(Years)	2	2	2
Certification	EN50131 Grade 2	EN50131 Grade 2	EN50131 Grade 2

WIRELESS DUAL-TECH DETECTOR



WIRELESS OUTDOOR DUAL-TECH DETECTOR



Short Description	Wireless Dual-Tech Detector	Wireless Outdoor Dual-Tech Detector
Model	DS-PD2-D12-W	DS-PD2-T12P-WEL
Dimensions(L x W x H) (mm)	69*117*59	188*77*84
Detection Range	12m	12
Detection Angle	85°	2,4
Mounting Height (m)	1.8-2.4	1,2
Animal immunity (kg)	No	Up to 35
Creep-Zone protection	Support	No
Microwave Frequency	10.515GHz, 10.525GHz, 10.535GHz	10.515GHz, 10.525GHz, 10.535GHz
Tamper protection	Support	Support
Signal Strength Indicators (SSI)	Support	Support
Walk Test Buzzer	No	Support
LED indication for Microwave, infered and alarm	Support	Support
Transmission frequency	868mhz	868mhz
3V lithium battery included	Yes	2x 3V 5Ah (BATT-ES1)
Minimal Battery Life(Years)	2	2
Certification	EN50131 Grade 2	EN50131 Grade 2
Environmental protection grade	N/A	IV





WIRELESS INPUT EXPANDER



WIRELESS OUTPUT EXPANDER



Short Description	wireless Input expander	wireless output expander	wireless output expander
Model	DS-PM-WI1	DS-PM-WO2	DS-PM-WO8
Dimensions(L x W x H) (mm)	84 mm × 25 mm × 21 mm (2.52" × 0.75" × 0.63")	160 mm × 105 mm × 28 mm (6.29" × 4.13" × 1.10")	160 mm × 105 mm × 28 mm (6.29" × 4.13" × 1.10")
Input	1 NC input		
output		2, NO/NC	8, NO/NC
Transmission frequency	868MHz	868MHz	868MHz
Battery			
Power Supply	CR123 A/3 V	9 to 15 VDC	9 to 15 VDC

	KEYPAD		TWO-WAY KEYFOB	KEYFOB	INDOOR SIREN
Short Description	 Two-way keypad 868M (Black)	 Two-way keypad 868M (white)	 Two-way Keyfob 868M	 Keyfob	 wireless indoor siren
Model	DS-PKA-WLM-868 (Black)	DS-PKA-WLM-868 (White)	DS-PKFE-5 (868)	DS-PKFS-4	DS-PSG-WI-868
Dimensions(L x W x H) (mm)	φ 131.5 mm (5.2"); height: 23 mm (0.9")	φ 131.5 mm (5.2"); height: 23 mm (0.9")	63* 49*16	72*30m*20	90.0 × 90.0 × 30.0 mm (35.4" × 35.4" × 11.8")
Weight			24.5g	28g	
Transmission frequency	868 mhz	868 mhz	868mhz	868mhz	868 MHz
Button			5	4	
Encryption Scheme	AES-128	AES-128	Rolling code DES	Rolling code DES	AES-128
Battery Life	3 years	3 years	2 years	2 years	5 years in stand-by status
Distance (open space)	800 m (open area)	800 m (open area)	300m	500m	800 m (open area)
RF method	Two way communication	Two way communication	Two way communication	Two way communication	Two-way communication
RF speed	10.0 kbps/4.8 bps	10.0 kbps/4.8 bps			10 kbps/4.8 kbps
RF modulation	2GFSK	2GFSK			2GFSK
RF power	10 dBm	10 dBm			13 dBm
TAMPER switch	1	1			Front and rear panel tamper-proof
RF module	Communicates with wireless control panel	Communicates with wireless control panel			
Card	Supports standard IC card swiping	Supports standard IC card swiping			
Buzzer	1	1			Decibel: 110 dB
Serial port	1, reserved	1, reserved			
Numeric	10 keys: 0 to 9	10 keys: 0 to 9			
Function key	6 function keys: fire alarm, away arming, stay arming, disarming, delete, and confirm	6 function keys: fire alarm, away arming, stay arming, disarming, delete, and confirm			
Protocol	HIK wireless protocol: Access to wireless control panel, twoway communication	HIK wireless protocol: Access to wireless control panel, twoway communication			
Power	3 VDC power input	3 VDC power input			4 CR123A Batteries (default) or 12 VDC
Battery type	4 AA batteries	4 AA batteries			4 CR123A
Operation humidity	10% to 90% (No condensing)	10% to 90% (No condensing)			10% to 90% (no condensing)
Operation temperature	-10 °C to +55 °C (-4 °F to +122 °F)	-10 °C to +55 °C (-4 °F to +122 °F)			-10 °C to +60 °C (14 °F to +140 °F)
Color	Black	White			White
Installation	Wall mounting	Wall mounting			Wall mounting

	OUTDOOR SIREN	TAG READER	
Short Description	 wireless outdoor siren	 Two-way Tag Reader 868M (black)	 Two-way Tag Reader 868M (white)
Model	DS-PSG-WO-868	DS-PTA-WL-868(black)	DS-PTA-WL-868(white)
Dimensions(L x W x H) (mm)	220.5 × 205.2 × 46 mm (8.68" × 8.08" × 1.81")	90.78 mm × 90.78 mm × 15.5 mm (3.57" × 3.57" × 0.61")	90.78 mm × 90.78 mm × 15.5 mm (3.57" × 3.57" × 0.61")
Weight			
Transmission frequency	868 MHz	868 mhz	868 mhz
Button			
Encryption Scheme	AES-128	AES-128	AES-128
Battery Life	5 years in stand-by status	5 years in stand-by status	5 years in stand-by status
Distance (open space)	800 m (open area)	800 m (open area)	800 m (open area)
RF method	Two-way communication	Two way communication	Two way communication
RF speed	10 kbps/4.8 kbps	10.0kbps/4.8kbps	10.0kbps/4.8kbps
RF modulation	2GFSK		
RF power	13 dBm	10 dBm	10 dBm
TAMPER switch	Front and rear panel tamper-proof	1	1
RF module		Communicates with wireless control panel	Communicates with wireless control panel
Card		Supports standard IC card swiping	Supports standard IC card swiping
Buzzer	1, Decibel: 110 dB	Prompt for card operation and tampering alarm	Prompt for card operation and tampering alarm
Serial port			
Numeric			
Function key			
Protocol		HIK wireless protocol: Access to wireless control panel, twowaycommunication	HIK wireless protocol: Access to wireless control panel, twowaycommunication
Power	4 CR123A Batteries (default) or 12 VDC	3 VDC power input	3 VDC power input
Battery type	4CR123A	4 AAA batteries	4 AAA batteries
Operation humidity	10% to 90% (no condensing)	10% to 90% (no condensing)	10% to 90% (no condensing)
Operation temperature	-25 °C to +60 °C (-13 °F to +140 °F)	-20°C to +60°C (-4°F to +140°F)	-20°C to +60°C (-4°F to +140°F)
Color	White and blue	black	white
Installation	Wall mounting	Wall mounting	Wall mounting

WIRELESS MAGENETIC CONTACT



Short Description	Wireless Magenetic Contact	Wireless Magenetic Contact
Model	DS-PD1-MC-WWS	DS-PD1-MC-WWS(H)
RF transmit distance	800m (Open area)	800m (Open area)
Tamper proof	Support	Support
Transmit frequency	868mhz	868mhz
Dimension(mm)	27*104* 25	84*25*20.99
Weight(g)		37
Battery Life (Years)	2	2

DISPLAYS

Hikvision also offers a selection of monitors to complement your security solution. Whatever size you need - from 19" to 84", our LED displays give you eyes on your scenario.

SWITCHES

Hikvision also offers a range of professional switches to maximise the effect of your solution by extending your reach and increasing your data capacity.

	18.5"	21.5"	23.6"	23.6"
				
Short Description	19" 1080P Monitor	22" 1080P Monitor	22" 1080P Monitor	24" 1080P Monitor
Model	DS-D5019QE-B/EU	DS-D5022FC(EU)	DS-D5022QE-B/EU	DS-D5024FC
Display Type	LED-Backlit TFT LCD	LED-Backlit	LED-Backlit	LED-Backlit
Resolution	1366 x 768	1920 x 1080	1920 x 1080	1920 x 1080
Brightness	200 cd/m ² (Typical)	250cd/m ² (Typical)	250cd/m ² (Typical)	250cd/m ² (Typical)
Contrast	600:1	1000:1	1000:1	1000:1(Typical) DCR 30,000,000:1
Response Time	5ms	5ms	5ms	5ms
Viewing Angle	Horizontal 90°, Vertical 65°	Horizontal 170°, Vertical 160°	Horizontal 170°, Vertical 160°	Horizontal 170°, Vertical 160°
Interfaces	HDMI Input:1VGA Input:1	HDMI Input:1 USB Port: 1 VGA Input:1 BNC Input:1 BNC Output:1	HDMI Input:1 VGA Input:1	HDMI Input:1 VGA Input:1BNC Input:1BNC Output:1
Audio		Audio Input: 1 Audio Output: 1		Audio Input:1x 3.5 mm mini-jack , 1x RCA typeSpeaker:2x 2W
VESA	75 mm x 75 mm	100mm x 100mm	100mm x 100mm	100mm x 100mm
Power Supply	100 to 240 VAC, 50/60Hz	DC 12V/3.0A	100 - 240V AC	AC 100-240V
Power Consumption	< 25 W(on) < 0.5 W(Standby)	< 30W(on) < 0.5W(Standby)	< 30W(on) < 0.4W(Standby)	< 30W(on) < 0.5W(Standby)
Operation Temperature	0°C - 40 °C	0°C - 40 °C	0°C - 40 °C	0°C - 40 °C
Dimension	445.58 mm x 274.99 mm x 44.6mm	511.4mm x 313.0mm x 45.4mm	511mmx377mmx170mm	561x339x218.5 (mm)22.1x13.3x8.6(inch)
Weight	3.5 Kg(Gross weight) , 2.8 Kg(Net weight)	4.6Kg(Gross weight) , 3.2(Net weight)	4.5Kg(Gross weight) , 3.3(Net weight)	6.0Kg(Gross weight) , 5.1(Net weight)

	23.8"	27"	28"	32"
				
Short Description	24" 1080P Monitor	27" 1080P Monitor	28" 4K Monitor	32" 1080P Monitor
Model	DS-D5024QE	DS-D5027FN	DS-D5028UC	DS-D5032FC-A
Display Type	LED-Backlit TFT LCD	TFT-LED Backlight	LED Backlight	TFT-LED Backlight
Resolution	1920 x 1080	1920 x 1080	3840 x 2160@60Hz	1920 x 1080
Brightness	250cd/m ² (Typical)	300cd/m ²	300 cd/m ²	300 cd/m ²
Contrast	1000:1(Typical)	1000:1	1100 : 1	1000:1
Response Time	14ms	14ms	5.5 ms	8 ms
Viewing Angle	Horizontal 178°, Vertical 178°	Horizontal 178°, vertical 178°	Horizontal 170°, vertical 160°	Horizontal 178°, Vertical 178°
Interfaces	HDMI Input:1 VGA Input:1	HDMI Input:1 VGA Input:1	HDMI Input:1 VGA Input:1 DP Input:1	HDMI Input:1 VGA Input:1DVI Input:1CVBS Input:1CVBS Output:1USB Input:1
Audio			Audio Input: 1	PC AUDIO-IN:1PC AUDIO-OUT:1Speaker:2 W x 2, 6Ω
VESA	100 mm x 100 mm	100mm x 100mm	100 mm x 100 mm	100 mm x 100 mm
Power Supply	AC100V - 240V 50/60Hz	100 to 240 VAC, 50/60Hz	AC 110-240V; 50/60Hz	100 to 240 VAC, 50/60Hz
Power Consumption	≤30W	≤ 35W	≤45W(Typ), ≤70W(Max)	≤ 45 W
Operation Temperature	0 to 40 ° C	0 to 40 ° C	0 to 40 ° C (0 to 104 ° F)	0°C - 40°C
Dimension	555 mm×339 mm×46 mm / 555mm×433mm×226mm(with base)	646 mm×385 mm×50 mm / 646 mm×447 mm×220 mm(with base)	659.7(W)X390.9(H)X49.3mm(D)	728.8 mm x 526 mm x 167.2 mm
Weight	5.1Kg(Gross weight) , 3.7Kg(Net weight)	6.7 kg(Gross weight) , 5.34 kg(Net weight)	7.2Kg(Gross weight) , 5.6 Kg(Net weight)	9.25 Kg(Gross weight) , 5.75 Kg(Net weight)



43"

55"

Short Description	32" 1080P Monitor	32" 1080P Monitor	43" 1080P Monitor	43" 4k Monitor
Model	DS-D5032FL	DS-D5032QE	DS-D5043QE	DS-D5043UC
Display Type	LED-Backlit TFT LCD	TFT-LED Backlight	TFT-LED Backlight	LED Backlight
Resolution	1920 x 1080	1920 x 1080	1920 x 1080	3840 x 2160@60Hz
Brightness	400 cd/m ² (Typical)	300 cd/m ²	360cd/m ²	300 cd/m ²
Contrast	3000:1	1400:1	1200:1	1200:1
Response Time	6.5 ms	8 ms	8ms	8ms
Viewing Angle	Horizontal 178°, Vertical 178°	Horizontal 178°, Vertical 178°	Horizontal 178°, Vertical 178°	Horizontal 178°, vertical 178°
Interfaces	HDMI Input:1USB Port: 1 , VGA Input:1BNC Input:1DVI Input:1	HDMI Input:1 VGA Input, RJ45(RS232)	HDMI Input:1 VGA Input	HDMI Input:1 VGA Input:1 LAN:1 USB 2.0:1 USB 3.0:1
Audio	Audio Input: 1 Audio Output: 1Speaker:3W x 2	PC AUDIO-IN:1PC	PC AUDIO-IN:1,Build-in speaker, Audio 5W*2	Audio Input: 1 Audio Output: 2
VESA	200 mm x 200 mm	100 mm x 100 mm	200mm * 200mm	200mm*200mm/400mm*400mm
Power Supply	100 to 240 VAC, 50/60Hz	100 to 240 VAC, 50/60Hz	100 - 240 V AC, 50/60 Hz	100 to 240 VAC, 50/60Hz
Power Consumption	< 60W(on) < 1W(Standby)	≤ 45 W	≤75W	≤120W
Operation Temperature	0°C - 40 °C	0°C - 40°C	0 to 40 ° C	0 to 40 ° C (0 to 104 ° F)
Dimension	737.4 mm x 452.5 mm x 70.65 mm (29.03" x 17.81" x 2.78")	728.8 mm x 526 mm x 167.2 mm	968.18mm * 562.99mm * 76.8mm	1070mm * 696mm * 159 mm
Weight	19 Kg(Gross weight) ,12 Kg (Net weight)	6.763Kg(Gross weight) , 5.09(Net weight)	11.1Kg(Gross weight) , 8.2(Net weight)	12.35Kg(Gross weight) , 12.00 Kg(Net weight)

Short Description	55" 4k Display
Model	DS-D5055UC
Display Type	LED Backlight
Resolution	3840 x 2160@60Hz
Brightness	400 cd/m ²
Contrast	1200:1
Response Time	8ms
Viewing Angle	Horizontal 178°, vertical 178°
Interfaces	HDMI Input:1 VGA Input:1 LAN:1 USB 2.0:1 USB 3.0:1 SPDIF output:1
Audio	Audio input, Audio out
VESA	400mm*200mm/400mm*400mm
Power Supply	100 to 240 VAC, 50/60Hz
Power Consumption	≤180W
Operation Temperature	0 to 40 ° C (0 to 104 ° F)
Dimension	400mm*200mm/400mm*400mm
Weight	20.7Kg(Gross weight) , 16Kg(Net weight)

	10 PORTS	18 PORTS	26 PORTS
Short Description	10-ports 100Mbps Web-managed PoE Switch	18-ports 100Mbps Web-managed PoE Switch	26-ports 100Mbps Web-managed PoE Switch
Model	DS-3E1310P-E	DS-3E1318P-E	DS-3E1326P-E
Network Ports	10	18	26
PoE Port	8,10/100M RJ45 ports	16,10/100M RJ45 ports	24,10/100M RJ45 ports
Uplink Port	2 1000M COMBO ports	2 1000M COMBO ports	2 1000M COMBO ports
High Priority Ports	Port 1 to 8	Port 1 to 8	Port 1 - 8
PoE Standard	IEEE 802.3af, IEEE802.3at	IEEE 802.3af, IEEE802.3at	IEEE 802.3af, IEEE802.3at
PoE Power Budget	123W	230W	370W
Transmission Distance	Extend On:250m,10M,CAT 5eExtend Off:100m	Extend On:250m,10M,CAT 5e Extend Off:100m	Extend On:250m,10M,CAT 5eExtend Off:100m
Power Supply	100-240V AC, 50/60Hz	100-240V AC, 50/60Hz	100 to 240 VAC, 50/60Hz
Surge Protection	4KV	4KV	
Working Temperature	00-400	00-400	0 °C to +40 °C (+32 °F to +104 °F)

	4PORTS	10 PORTS	18PORTS
Short Description	4-ports 1000Mbps Unmanaged PoE Switch	10-ports 1000Mbps Unmanaged PoE Switch	18-ports 1000Mbps Unmanaged PoE Switch
Model	DS-3E0505P-E	DS-3E0510P-E	DS-3E0518P-E
Network Ports	4	10	18
PoE Port	4,10/100M /1000 RJ45 ports	8,10/100M /1000 RJ45 ports	16,10/100M /1000 RJ45 ports
Uplink Port	1 Gigabit RJ45 uplink port	1 Gigabit RJ45 uplink port, 1 Gigabit SFP uplink port	1 Gigabit RJ45 uplink port, 1 Gigabit SFP uplink port
High Priority Ports			
PoE Standard		IEEE 802.3af, IEEE802.3at	IEEE 802.3af, IEEE802.3at
PoE Power Budget	60 W	110 W	230 W
Transmission Distance			
Power Supply		48 VDC, 2.5 A	100 to 240 VAC, 50/60 Hz, Max. 4 A
Surge Protection	6KV	6KV	6KV
Working Temperature	00-400	00-400	00-400

	6 PORTS	10 PORTS
Short Description	Industrial POE switch	Industrial POE switch
Model	DS-3T0306P	DS-3T0310P
Network Ports	6	10
PoE Port	4, 10/100Mbps RJ45 ports	8, 10/100Mbps RJ45 ports
Uplink Port	2,1000M SFP uplink port	2,1000M SFP uplink port
High Priority Ports		
PoE Standard	IEEE 802.3af, IEEE802.3at	IEEE 802.3af, IEEE802.3at
PoE Power Budget	120W	240W
Transmission Distance		
Power Supply	DC: 44~57VDC	DC: 44~57VDC
Surge Protection	6KV	6KV
Working Temperature	-40°C - 75°C	-40°C - 75°C



	OUTDOOR
Short Description	15km outdoor wifibridge
Model	DS-3WF03C
Network Ports	
PoE Port	
Uplink Port	
High Priority Ports	
PoE Standard	
PoE Power Budget	
Transmission Distance	
Power Supply	
Surge Protection	
Working Temperature	



6 PORTS





Short Description	4-ports 100Mbps Unmanaged hiPoE Switch
Model	DS-3E0106HP-E
Network Ports	6
PoE Port	4, 10/100Mbps RJ45 ports
Uplink Port	2, 10/100Mbps RJ45 ports
High Priority Ports	Ports 1 to 2
PoE Standard	IEEE 802.3af, IEEE802.3at, IEEE802.3bt
PoE Power Budget	60 W
Transmission Distance	Extend On:250m,10M,CAT 5eExtend Off:100m
Power Supply	Extend On:250m
Surge Protection	6KV
Working Temperature	00-400

BRACKET

MONITOR & LCD











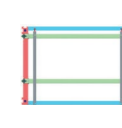

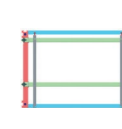

Monitor Model	Wall Mounted Bracket	Base Bracket
DS-D5019QE DS-D5019QE-B/EU DS-D5022QE-B/EU DS-D5024QE DS-D5027QE DS-D5032QE DS-D5022FC/EU DS-D5024FC DS-D5032FC-A DS-D5028UC	 DS-DM1940W Wall-mounted bracket, available for size from 19 to 40 (VESA standard), M4/M6, 75x75,100x100, 150x150, 200x200	base bracket included in monitor's package
DS-D5032FL DS-D5032FL-B DS-D5032FL-C	 DS-DM1940W Wall-mounted bracket, available for size from 19 to 40 (VESA standard), M4/M6, 75x75,100x100, 150x150, 200x200	DS-DM3201B Base bracket, available for DS-D5032FL, DS-D5032FL-B, DS-D5032FL-C, M6, 200x200
DS-D5040FC	 DS-DM1940W Wall-mounted bracket, available for size from 19 to 40 (VESA standard), M4/M6, 75x75,100x100, 150x150, 200x200	DS-DM4001B Base bracket, available for DS-D5040FC, M4, 100x100



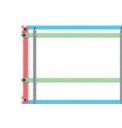



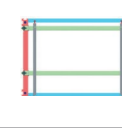

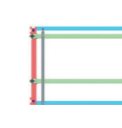

Monitor Model	Wall Mounted Bracket	Base Bracket
DS-D5043FC	 DS-DM4255W Wall-mounted bracket, available for size from 42 to 55(VESA standard), M6, 200x200, 300x300, 400x400	DS-DM4302B Base bracket, available for DS-D5043FC, M6, 200x300
DS-D5043FL	 DS-DM4255W Wall-mounted bracket, available for size from 42 to 55(VESA standard), M6, 200x200, 300x300, 400x400	DS-DM4301B Base bracket, available for DS-D5043FL, M6, 400x200
DS-D5049FL	 DS-DM4255W Wall-mounted bracket, available for size from 42 to 55(VESA standard), M6, 200x200, 300x300, 400x400	DS-DM4901B Base bracket, available for DS-D5049FL, M6, 300x200

Monitor Model	Wall Mounted Bracket	Base Bracket
DS-D5055FL	 DS-DM4255W Wall-mounted bracket, available for size from 42 to 55(VESA standard), M6, 200x200, 300x300, 400x400	DS-DM5501B Base bracket, available for DS-D5055FL, M6, 400x300
DS-D5050UC	 DS-DM4255W Wall-mounted bracket, available for size from 42 to 55(VESA standard), M6, 200x200, 300x300, 400x400	coming soon
DS-D5055UL-B	 DS-DM4255W Wall-mounted bracket, available for size from 42 to 55(VESA standard), M6, 200x200, 300x300, 400x400	DS-DM5502B Base bracket, available for DS-D5055UL-B, M6, 300x200
DS-D5086UL	 DS-DM6586W Wall-mounted bracket, available for size from 65 to 86(VESA standard), M8, 600x400, 600x500, 500x500	coming soon

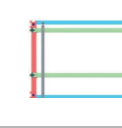
BRACKET



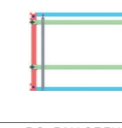





MONITOR & LCD

LCD video wall Model	Wall Mounted Push& PullBracket	Wall Mounted normal Bracket	Floor Standing Modular Bracket	
			Cabinet Frame	Base Frame
DS-D2046NL-B				
	DS-DN4601W	DS-DN4655W/U	DS-DN46B1M/F	DS-DN46B1M/B
	Front-maintenance wall-mounted bracket, suitable for all 46" LCD models.	Wall-mounted bracket, suitable for all 46", 49" and 55" LCD models.	Modular bracket, frame part, available for DS-D2046NL-B	Modular bracket, Pedestal part, available for DS-D2046NL-B, DS-D2046NL-B/Z, DS-D2046NH-B/Z, Hight: 800mm
DS-D2046NL-C DS-D2046NH-C				
	DS-DN4601W	DS-DN4655W/U	DS-DN46C2M/F	DS-DN46C2M/B
	Front-maintenance wall-mounted bracket, suitable for all 46" LCD models.	Wall-mounted bracket, suitable for all 46", 49" and 55" LCD models.	Modular bracket, frame part, available for DS-D2046NL-C and DS-D2046NH-C	Modular bracket, Pedestal part, available for DS-D2046NL-C and DS-D2046NH-C, Hight: 800mm
DS-D2046NH-E				
	DS-DN4601W	DS-DN4655W/U	DS-DN46E3M/F	DS-DN46E3M/B
	Front-maintenance wall-mounted bracket, suitable for all 46" LCD models.	Wall-mounted bracket, suitable for all 46", 49" and 55" LCD models.	Modular bracket, frame part, available for DS-D2046NH-E	Modular bracket, Pedestal part, available for DS-D2046NH-E, Hight: 800mm
DS-D2049NL-B				
	DS-DN4901W	DS-DN4655W/U	DS-DN49B4M/F	DS-DN49B4M/B
	Front-maintenance wall-mounted bracket, suitable for all 49" LCD models.	Wall-mounted bracket, suitable for all 46", 49" and 55" LCD models.	Modular bracket, frame part, available for DS-D2049NL-B	Modular bracket, Pedestal part, available for DS-D2049NL-B, Hight: 800mm









LCD video wall Model	Wall Mounted Push& PullBracket	Wall Mounted normal Bracket	Floor Standing Modular Bracket	
			Cabinet Frame	Base Frame
DS-D2055NL-B DS-D2055NH-B				
	DS-DN5501W	DS-DN4655W/U	DS-DN55B4M/F	DS-DN55B3M/B
	Front-maintenance wall-mounted bracket, suitable for all 55" LCD models.	Wall-mounted bracket, suitable for all 46", 49" and 55" LCD models.	Modular bracket, frame part, available for DS-D2055NL-B and DS-D2055NH-B	Modular bracket, Pedestal part, available for DS-D2055NL-B, DS-D2055NH-B, DS-D2055NH-B/G, DS-D2055NL-B/G, Hight: 800mm
DS-D2055NL-B/G DS-D2055NH-B/G				
	DS-DN5501W	DS-DN4655W/U	DS-DN55B3M/F	DS-DN55B3M/B
	Front-maintenance wall-mounted bracket, suitable for all 55" LCD models.	Wall-mounted bracket, suitable for all 46", 49" and 55" LCD models.	Modular bracket, frame part, available for DS-D2055NH-B/G, DS-D2055NL-B/G	Modular bracket, Pedestal part, available for DS-D2055NL-B, DS-D2055NH-B, DS-D2055NH-B/G, DS-D2055NL-B/G, Hight: 800mm
DS-D2055NL-E/G DS-D2055NH-E/G				
	DS-DN5501W	DS-DN4655W/U	DS-DN55E4M/F	DS-DN55E4M/B
	Front-maintenance wall-mounted bracket, suitable for all 55" LCD models.	Wall-mounted bracket, suitable for all 46", 49" and 55" LCD models.	Modular bracket, frame part, available for DS-D2055NL-E/G, DS-D2055NH-E/G	Modular bracket, Pedestal part, available for DS-D2055NL-E/G, DS-D2055NH-E/G, Hight: 800mm

BRACKET











ANALOGUE CAMERA











Product form	Model	Relevant brackets and housings					
		Indoor		Indoor housing		Outdoor housing	
	DS-2CC1209T-A DS-2CC1209T-E						
		DS-1299ZJ Pendant Mount	DS-1280ZJ-XS Junction box	DS-1292ZJ Wall mount	DS-1332HZ Indoor housing	DS-1330HZ Indoor housing	DS-1331HZ Series Outdoor housing
	DS-2CE37U8T-A	Hik white Aluminum Alloy 77×77×198mm 165g	Hik white Aluminum Alloy Φ100 x 43.2 x 129mm 320g (Match up with DS-1299ZJ)	Hik white Aluminum alloy 70×97.1×217.9mm 201g	Hik white Aluminum alloy 288×149×100mm 800g	Hik white Complex fiber 290×142×92mm 640g	Hik white Aluminum alloy

Product form	Model	Relevant brackets and housings				Product form	Model	Product form	Model	Relevant brackets and housings
		Indoor/Outdoor								
	DS-2CE16C5T-[A]VFIR3						DS-2CE16D0T-I3F DS-2CE16D3T-I3(P)F DS-2CE16D0T-I2FD DS-2CE16D0T-I2PFD		DS-2CE16D8T-IT(F)(E) DS-2CE16HST-ITE DS-2CE16H0T-IT(P)F DS-2CE16U1T-IT(P)F DS-2CE16D3T-IT(P)F	Indoor/Outdoor
		DS-1275ZJ-SUS Vertical pole mount	Junction box	Junction box	Corner mount		DS-2CE16C0T-IR(P)(F) DS-2CE16C2T-IR(P) DS-2CE16D0T-IR(P)(F)(E)		DS-2CE17U8T-IT	
	DS-2CE16C5T-IT1/IT3 DS-2CE16C2T-IT5 DS-2CE16C5T-IT5						DS-2CE16C2T-IT1/IT3		DS-2CE11D8T-PIRL(P)(O) DS-2CE11H0T-PIRL(P)(O) DS-2CE11D0T-PIRL(P)(O)	Junction box
		Hik white Stainless Steel 127×46× 250mm Diameter of clamp: Φ67 -127mm 1205g	Hik white Aluminum alloy Φ137 x 53.4x 164.8mm 527g	Hik white Aluminum alloy Φ105 mm	Hik white Stainless Steel 126×105× 250mm 2280g		DS-2CC1209T-IT3E/IT5E DS-2CE16C0T-IT1/IT3/IT5 DS-2CE16D0T-IT1/IT3/IT5 DS-2CE16D8T-IT1(F)(E)/IT3(F)(E)/IT5(F)(E) DS-2CE16HST-IT1/3/5E DS-2CE16H0T-IT1/3/5F(E) DS-2CE16H8T-IT1/3/5F DS-2CE16U1T-IT1/3/5F DS-2CE16U7T-IT1/3/5F DS-2CE16D3T-IT1/3/5F DS-2CE16C5T-IT5		DS-2CE12D8T-PIRL(O) DS-2CE12H0T-PIRL(O) DS-2CE18U8T-IT3 DS-2CE12D0T-PIRL(O)	Hik white Aluminum Alloy Φ100 x 43.2 x 129mm 320g
	DS-2CE16D9T-AIRAZH						DS-2CE16H8T-ITF DS-2CE16U7T-ITF		DS-2CE10DFT-F	
									DS-2CE12DFT-F	



Product form	Model	Relevant brackets and housings		
		Indoor/Outdoor		
	DS-2CC12D9T-AIT3ZE DS-2CE16D8T-(A)IT3(F)I(Z)			
		DS-1275ZJ-SUS Vertical pole mount	DS-1280ZJ-S Junction box	DS-1276ZJ-SUS Corner mount
	DS-2CE16H5T-(A)IT3Z DS-2CE16H0T-(A)IT3ZF DS-2CE19H8T-(A)IT3ZF DS-2CE19U1T-(A)IT3ZF DS-2CE19U7T-(A)IT3ZF DS-2CE19D3T-(A)IT3ZF	Hik white Stainless Steel 127×46×250mm Diameter of clamp: Ø67-127mm 1480g	Hik white Aluminum alloy Ø137 x 53.4x 164.8mm 527g	Hik white Stainless Steel 126×105×250mm 2280g
	DS-2CE16C2T-VFIR3 DS-2CE16D0T-VFIR3F			
	DS-2CE19U8T-(A)IT3Z			
	DS-2CE16C5T-AIT3Z			





Product form	Model	Relevant brackets and housings									
		Indoor/Outdoor									
	DS-2CE59U7T-(A)VPIT3ZF DS-2CE59H8T-(A)VPIT3ZF DS-2CE59U1T-(A)VPIT3ZF										
		DS-1271ZJ-140	DS-1273ZJ-140	DS-1273ZJ-140B	DS-1241ZJ	DS-1240ZJ	DS-1275ZJ-SUS	DS-1276ZJ-SUS	DS-1253ZJ-L	DS-1250ZJ	
	DS-2CE59U8T-(A)VPIT3Z	Pendant Mount	Wall mount	Wall mount	In-ceiling mount	Inclined ceiling mount	Vertical pole mount	Corner mount	Rain shade	Rain shade	
	DS-2CE56C5T-(A)VIPR3	Hik white Aluminum alloy Ø150×565mm 1900g	Hik white Aluminum alloy 140×183.5×232mm 703g	Hik white Aluminum alloy with junction box 140×243×292mm 1488g	Hik white Aluminum alloy Ø200×26.8mm 300g	Hik white Aluminum alloy Ø145×63mm 440g	Hik white Stainless Steel 127×46×250mm Diameter of clamp: Ø67-127mm 1480g Match up with wall mount(DS-1273ZJ- XX(B))	Hik white Stainless Steel 126X105X250mm 2280g Match up with wall mount(DS-1273ZJ- XX(B))	Hik white Composite Fibre Ø225.1×98mm 198g Match up with wall mount(DS-1273ZJ- 140)	Hik white Composite Fibre 264.7*152*189.6 mm 199g	





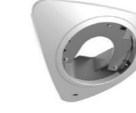





Product form	Model	Relevant brackets and housings							
		Indoor							
	DS-2CE56H8T-(A)ITZF DS-2CE56U1T-(A)ITZF								
		DS-1271ZJ-130	DS-1273ZJ-130	DS-1273ZJ-130B	DS-1249ZJ	DS-1275ZJ-SUS	DS-1276ZJ-SUS	DS-1253ZJ-L	DS-1250ZJ
	DS-2CE56C5T-(A)VFIR DS-2CE56D0T-VFIRF	Pendant Mount	Wall mount	Wall mount	In-ceiling mount	Vertical pole mount	Corner mount	Rain shade	Rain shade
	DS-2CC52D9T-AITZE DS-2CE56D8T-(A)ITZF(E) DS-2CE5AD8T-AVIT3Z DS-2CE56H5T-(A)ITZF(E) DS-2CE56H0T-(A)ITZF DS-2CE56H0T-ITZE	Hik white Aluminum alloy Ø150×565mm 1900g	Hik white Aluminum alloy 132×183.5×228.5mm 690g	Hik white Aluminum alloy with junction box 132×243×288.5mm 1475g	Hik white ABS plastic Ø169.4×14.6mm 60g	Hik white Stainless Steel 127×46×250mm Diameter of clamp: Ø67- 127mm 1480g Match up with wall mount(DS-1273ZJ-XX(B))	Hik white Stainless Steel 126X105X250mm 2280g Match up with wall mount(DS-1273ZJ-XX(B))	Hik white Composite Fibre Ø225.1×98mm 198g Match up with wall mount(DS-1273ZJ-130)	Hik white Composite Fibre 264.7*152*189.6 mm 199g

Product form	Model	Relevant brackets and housings									
		Indoor									
	DS-2CE56D8T-VPITF(E) DS-2CE56H5T-VPITE DS-2CE56H0T-VPITF(I)(E) DS-2CE57U8T-VPIT DS-2CE57D3T-VPITF DS-2CE57H8T-VPITF DS-2CE57U1T-VPITF DS-2CE57U7T-VPITF										
		DS-1259ZJ	DS-1271ZJ-110	DS-1272ZJ-110	DS-1272ZJ-110B	DS-1275ZJ-SUS	DS-1276ZJ-SUS	DS-1280ZJ-DM18	DS-1258ZJ	DS-1253ZJ-M	DS-1250ZJ
	DS-2CE56C0T-VPiR	Hik white ABS Plastic Ø111×39.2mm 200g	Hik white Aluminum alloy Ø150×560mm 1900g	Hik white Aluminum alloy 120×122×169mm 420g	Hik white Aluminum alloy with junction box 123×180×227.8mm 1205g	Hik white Stainless Steel 127×46×250mm Diameter of clamp: Ø67-127mm 1205g Match up with wall mount(DS- 1272ZJ-110)	Hik white Stainless Steel 126X105X250mm 2280g Match up with wall mount(DS- 1272ZJ-110)	Hik white Aluminum alloy Ø115.4×43.8mm 450g	Hik white ABS plastic 120×111×161.5mm 200g	Hik white Composite Fibre Ø191.1×76mm 133g Match up with wall mount(DS- 1272ZJ-110)	Hik white Composite Fibre 264.7*152*189.6 mm 199g

Product form	Model	Relevant brackets and housings										
		Indoor/Outdoor										
	DS-2CE5AD0T-VPI3F DS-2CE5AD8T-VPI3Z											
		Pendant mount	Wall mount	Wall mount with junction box	Vertical pole mount	Corner mount	In-ceiling mount	Junction box	Inclined ceiling mount	Rain shade	Rain shade	Wall mount
		Hik white Aluminum alloy 150×150×565mm 1900g	Hik white Aluminum alloy 136×183.5×230mm 704g	Hik white Aluminum alloy with junction box 136×243×290mm 1490g	Hik white Stainless Steel 127×46×250mm Diameter of clamp: Ø67-127mm 1205g Match up with wall mount (DS-1273ZJ-135)	Hik white Stainless Steel 126X105X250mm 2280g Match up with wall mount(DS-1273ZJ-135)	Hik white Aluminum alloy & ABS Plastic Ø210×90mm 540g	Hik white Aluminum alloy 162×137×42mm 250g	Hik white Aluminum alloy 136.3×136.3×48mm 245g	Hik white Composite Fibre Ø225.1×98mm 198g Match up with wall mount (DS-1273ZJ-135)	Hik white Composite Fibre 264.7×152×189.6mm 199g	Hik white Plastic 136×183×213mm 260g

Product form	Model	Relevant brackets and housings						
		Indoor/Outdoor						
	DS-2CE56D8T-IRS							
		Wall mount	Wall mount	Pendant mount	Vertical pole mount	Corner mount	Gang box	Junction box
		Hik white Aluminum alloy 120×122×173.5mm 430g	Hik white Aluminum alloy with junction box 123×180×223mm 1225g	Hik white Aluminum alloy Ø150×573mm 1900g	Hik white Stainless Steel 127×46×250mm Diameter of clamp: Ø67-127mm 1205g Match up with wall mount(DS-1272ZJ-120)	Hik white Stainless Steel 126X105X250mm 2280g Match up with wall mount(DS-1272ZJ-120)	Hik white Plastic Ø120 mm	Hik white Aluminum alloy 164.8×137×53.4mm 520g

Product form	Model	Relevant brackets and housings						
		Indoor						
	DS-2CC52C7T-VP1R							
		Corner mount	Wall mount	Inclined ceiling mount	Pendant mount (extendable)	Pendant Mount	Pendant mount (extendable)	Pendant mount (extendable)
		Hik white Aluminum alloy 233×201×96mm	Hik white Toughened Plastic 223.9×80×125.8mm 450g	Hik white Plastic 111.8×40.5×108.3mm 45.8g	Hik white Aluminum alloy (Height 1000-2000mm)	Hik white Aluminum Alloy 77×77×198mm 165g	Hikvision White Aluminum Alloy Ø97 mm × 270 mm to 400 mm (Ø 3.82 × 10.63 to 15.75) 500 g (1.10 lb.)	Hikvision White Aluminum Alloy Ø120 mm × 650 mm to 1200 mm (Ø 4.72 × 25.59 to 47.24) 800 g (1.76 lb.)











Product form	Model	Relevant brackets and housings			
		Indoor/Outdoor			
	DS-2CE56C2T-IRM DS-2CE56C0T-IRM DS-2CE56D0T-IRM				
		Wall mount	Vertical pole mount	Corner mount	Junction box
		Hik white Aluminum alloy 120×122×169mm 420g	Hik white Stainless Steel 127×46×250mm Diameter of clamp: Ø67-127mm 1480g Match up with wall mount(DS-1272ZJ-XX(B))	Hik white Stainless Steel 126X105X250mm 2280g Match up with wall mount(DS-1272ZJ-XX(B))	Hik white Aluminum Alloy Ø100 x 43.2 x 129mm 320g
	DS-2CE56H0T-ITPF				
	DS-2CE76U1T-ITPF				
	DS-2CE56H0T-ITMF DS-2CE56H0T-ITME DS-2CE56D8T-ITM(F)(E) DS-2CE56H5T-ITME				
	DS-2CE76D3T-ITMF DS-2CE76H8T-ITMF DS-2CE76U1T-ITMF DS-2CE76U7T-ITMF				
	DS-2CE56C0T-IR(P)F DS-2CE56C2T-IR(P)				
	DS-2CE56D0T-IR(P)F DS-2CE56D0T-I2(P)FD				

*The -TRS means it has adapter plate compared to DS-1272ZJ-110. Special for these mini dome cameras

Product form	Model	Relevant brackets and housings						
		Indoor/Outdoor						
	DS-2CE56C2T-IT1/IT3 DS-2CE56C5T-IT1/IT3							
		DS-1272ZJ-110 Wall mount	DS-1275ZJ-SUS Vertical pole mount	DS-1276ZJ-SUS Corner mount	DS-1258ZJ Wall mount	DS-1280ZJ-S Junction box	DS-1281ZJ-S Inclined ceiling mount	DS-1271ZJ-110 Pendant mount
		Hik white Aluminum alloy 120×122×169mm 420g	Hik white Stainless Steel 127×46×250mm Diameter of clamp: Ø67-127mm 1480g Match up with wall mount[DS-1272ZJ-XX(B)]	Hik white Stainless Steel 126×105×250mm 2280g Match up with wall mount [DS-1272ZJ-XX(B)]	Hik white ABS plastic 120×111×161.5mm 200g Suitable for indoor	Hik white Aluminum alloy 137×53.4×164.8mm 527g	Hik white Aluminum alloy 137×56.5×147mm 472g	Hik white Aluminum alloy Ø150×560mm 1900g

Product form	Model	Relevant brackets and housings					
		Indoor/Outdoor					
	DS-2CE56C5T-VF1T3						
	DS-2CE56C2T-VF1R3	DS-1273ZJ-130-TRL Wall mount	DS-1275ZJ-SUS Vertical pole mount	DS-1276ZJ-SUS Corner mount	DS-1280ZJ-M Junction box	DS-1281ZJ-M Inclined ceiling mount	DS-1271ZJ-130-TRL Pendant mount
		Hik white Aluminum alloy 131×183.5×228.5mm 890g	Hik white Stainless Steel 127×46×250mm Diameter of clamp: Ø67-127mm 1480g Match up with wall mount[DS-1273ZJ-XX(B)]	Hik white Stainless Steel 126×105×250mm 2280g Match up with wall mount[DS-1273ZJ-XX(B)]	Hik white Aluminum alloy 157×184.8×53.4mm 621g	Hik white Aluminum alloy 157×165.7×61.8mm 586g	Hik white Aluminum alloy Ø150×567mm









Product form	Model	Relevant brackets and housings					
		Indoor/Outdoor					
	DS-2CE56D8T-IT3Z(F)(E) DS-2CE56C5T-IT3Z						
	DS-2CE56H5T-IT3Z(E) DS-2CE56H0T-IT3Z(F)(E) DS-2CE79U8T-IT3Z DS-2CE79D3T-IT3ZF DS-2CE79H8T-IT3ZF DS-2CE79U1T-IT3ZF DS-2CE79U7T-IT3ZF	DS-1273ZJ-130-TRL Wall mount	DS-1275ZJ-SUS Vertical pole mount	DS-1276ZJ-SUS Corner mount	DS-1280ZJ-TR12 Junction box	DS-1281ZJ-M Inclined ceiling mount	DS-1271ZJ-130-TRL Pendant mount
		Hik white Aluminum alloy 131×183.5×228.5mm 890g	Hik white Stainless Steel 127×46×250mm Diameter of clamp: Ø67-127mm 1480g Match up with wall mount[DS-1273ZJ-XX(B)]	Hik white Stainless Steel 126×105×250mm 2280g Match up with wall mount[DS-1273ZJ-XX(B)]	Hikvision White Alloy 123.06 mm × 168.24 mm × 45 mm (4.84" × 6.62" × 1.77") 215 g [0.47 lb.]	Hik white Aluminum alloy 157×165.7×61.8mm 586g	Hik white Aluminum alloy Ø150×567mm









Product form	Model	Relevant brackets and housings				
		Indoor/Outdoor				
	DS-2CE7803T-IT3F DS-2CE78H8T-IT1/3F DS-2CE78U1T-IT1/3F DS-2CE78U7T-IT1/3F					
	DS-2CE56C0T-IT1/IT3 DS-2CE56D0T-IT1/IT3 DS-2CC52D9T-IT3E DS-2CE56D8T-IT1(F)(E)/IT3(F)(E) DS-2CE56H5T-IT1/3/E DS-2CE56H0T-IT1/3(F)(E) DS-2CE56C5T-IT3	DS-1272ZJ-110-TRS Wall mount	DS-1275ZJ-SUS Vertical pole mount	DS-1276ZJ-SUS Corner mount	DS-1280ZJ-S Junction box	DS-1281ZJ-S Inclined ceiling mount
	DS-2CE71D8T-PIRL(O) DS-2CE71D0T-PIRL(P)(O) DS-2CE71H0T-PIRL(P)(O)	Hik white Aluminum alloy 110×120×120mm 420g	Hik white Stainless Steel 127×46×250mm Diameter of clamp: Ø67-127mm 1480g Match up with wall mount [DS-1272ZJ-XX(B)]	Hik white Stainless Steel 126×105×250mm 2280g Match up with wall mount [DS-1272ZJ-XX(B)]	Hik white Aluminum alloy 137×53.4×164.8mm 527g	Hik white Aluminum alloy 137×56.5×147mm 472g
	DS-2CE78U8T-IT3					
	DS-2CE72DFT-F					







BRACKET



IP CAMERA





Product form	Model	Relevant brackets and housings					
		Indoor		Indoor housing		Outdoor housing	
	DS-2CD4025FWD-(A)(P)/(B) DS-2CD4035F-(A)(P)/(B) DS-2CD4035FWD-(A)(P)/(B) DS-2CD4065F-(A)(P)/(B) DS-2CD4085F-(A)(P)/(B) DS-2CD40C5F-(A)(P)/(B)						
	DS-2CD4C16FWD-(A)(P) DS-2CD4C26FWD-(A)(P) DS-2CD4C36FWD-(A)(P) DS-2CD4026FWD-A/P	DS-1299ZJ Pendant Mount	DS-1292ZJ Wall mount	DS-1332HZ Indoor housing	DS-1330HZ Indoor housing	DS-1331HZ series Outdoor housing	DS-1340HZ Outdoor housing
	DS-2CD6026FHW-(A)	Hik white Aluminum Alloy 77×77×198mm 165g	Hik white Aluminum alloy 70×97.1×217.9mm 201g	Hik white Aluminum alloy 288×149×100mm 800g	Hik white Complex fiber 290×142×92mm 640g	Hik white Aluminum alloy	Three-axis adjustment Containing combined wires and fan IK10
	DS-2CD2821G0						
	DS-2CD5026G0-(AP) DS-2CD5046G0-(AP) DS-2CD5065G0-(AP) DS-2CD5085G0-(AP) DS-2CD50C5G0-(AP) DS-2CD7026G0(P)(AP) DS-2CD7046G0-(AP) DS-2CD7085G0-(AP)						
	iDS-2CD6026FWD-AF iDS-2CD6024FWD-A/F						

Product form	Model	Relevant brackets and housings							
		Outdoor							
	DS-2CD5028G0/E-HI								
		DS-1293ZJ-P Wall mount	DS-1269ZJ-P Pendant mount	DS-1214ZJ-TP Horizontal pole mount	DS-1233ZJ-P Column Mount	DS-1232ZJ-P Cardan Joint	DS-1232ZJ-TP Cardan Joint	DS-1275ZJ-P-SUS Vertical pole mount	DS-1275ZJ-SUS Vertical pole mount
		Platinum gray Aluminum alloy 88×116.6×297.3mm 473g	Platinum gray Aluminum alloy 493×246×88mm 480g	Platinum gray Steel(mounting board) & Stainless Steel(clamp)	Platinum gray Steel Ø160 x 1093mm 6200g	Platinum gray Steel 126×103.5×83mm 790	Platinum gray Steel 96×95×92.5mm	Platinum gray Stainless Steel 127×46×250mm Match up with wall mount(DS-1293ZJ-XX)	Hikvision White Stainless Steel 127 mm × 46 mm × 250 mm (5 × 1.81 × 9.84) 1480 g (3.26 lb.) Match up with wall mount(DS-1293ZJ-XX(B))



Product form	Model	Relevant brackets and housings							
		Indoor/ Outdoor							
	DS-2CD5026G0/E-(H)								
		DS-1293ZJ Wall mount	DS-1214ZJ Horizontal pole mount	DS-1275ZJ-SUS Vertical pole mount	DS-1269ZJ Pendant Mount	DS-1233ZJ Column Mount	DS-1276ZJ-SUS Corner mount	DS-1674ZJ Junction Box	DS-2202ZJ Wall Mount
		Hik white Aluminum alloy 88×116.6×297.3mm 473g	Hik white Steel(mounting board) & Stainless Steel(clamp) 117×226×194mm Diameter of clamp: Ø67- 127mm 1895g	Hikvision White Stainless Steel 127 mm × 46 mm × 250 mm (5 × 1.81 × 9.84) 1480 g (3.26 lb.) Match up with wall mount(DS-1293ZJ-XX(B))	Hik white Aluminum alloy 493×246×88mm 480g	Hik white Steel Ø160 x 1093mm 6200g	Hik white Stainless Steel 126×105×250mm 2280g Match up with wall mount(DS-1293ZJ-XX)	Hikvision White Aluminum Alloy 310 mm × 208.9 mm × 89 mm (12.20 × 8.22 × 3.50) 2380 g (5.25 lb.)	Hikvision White Aluminum Alloy ADC12 300.7 mm × 250.2 mm × 107.9 mm (9.85 × 9.85 × 4.25) 1250 g (2.76 lb.)



Product form	Model	Relevant brackets and housings					
		Indoor/Outdoor					
	DS-2CD6026FWD/E-(H) DS-2CD6233F/E-(H)(IR5)(IRA) DS-2CD4035FWD-E-(H)(IR5)(IRA) (HIRS)(HIRA) DS-2CD4065FE-(H)(IR5)(IRA)(HIR5) (HIRA) DS-2CD4085FE-(H)(IR5)(IRA)(HIR5) (HIRA) DS-2CD4026FWD-E-(H)(IR5)(IRA) DS-2CD4026FWD/P-L DS-2CD4026FWD/P-(IR5)(IRA) (INRA)(HIRA)(B)						
		DS-1293ZJ Wall mount	DS-1214ZJ Horizontal pole mount	DS-1275ZJ-SUS Vertical pole mount	DS-1269ZJ Pendant Mount	DS-1233ZJ Column Mount	DS-1276ZJ-SUS Corner mount
		Hik white Aluminum alloy 88×116.6×297.3mm 473g	Hik white Steel(mounting board) & Stain- less Steel(clamp) 117×226×194mm Diameter of clamp: Ø67-127mm 1895g	Hikvision White Stainless Steel 127 mm × 46 mm × 250 mm (5 × 1.81 × 9.84) 1480 g (3.26 lb.) Match up with wall mount(DS- 1293ZJ-XX(B))	Hik white Aluminum alloy 493×246×88mm 480g	Hik white Steel Ø160 x 1093mm 6200g	Hik white Stainless Steel 126×105×250mm 2280g Match up with wall mount(DS- 1293ZJ-XX)



Product form	Model	Relevant brackets and housings	
		Indoor	
	DS-2CD6412F- WD-10/11/20/21/30/31		
		DS-1290ZJ-BL Clamp bracket	DS-1291ZJ-BL Desktop/Pendant mount
	DS-2CD6424F- WD-10/20/30/40(E1/E2)	Black Plastic 90×70×22mm Only available for tube unit(-30 or -31 model)	Black Plastic 87×73×73mm Standard BOM, with this bracket in -10/30 by default

Product form	Model	Relevant brackets and housings			
		Indoor/Outdoor			
	DS-2CD4A24FWD- IZ(H)(S) DS-2CD4A25FWD- IZ(H)(S) DS-2CD4A35F-IZ(H)(S) DS-2CD4A35FWD- IZ(H)(S) DS-2CD4A65F-IZ(H)(S) DS-2CD4A85F-IZ(H)(S) DS-2CD4AC5F-IZ(H)(S) DS-2CD4A26FWD- IZ(H)(S) DS-2CD4A26FWD-(IZ')P) (IZS')P (ZHS')P (LZS')P) DS-2CD4A45G0-IZ(H)(S) DS-2CD4B45G0-IZS DS-2CD4B25G0-IZS DS-2CD4B36FWD-(IZ)S DS-2CD4B26FWD-IZS DS-2CD4B16FWD-IZS				
		DS-1275ZJ-SUS Vertical pole mount	DS-1276ZJ-SUS Corner mount	DS-1275ZJ-S-SUS Vertical pole mount	Rubber sleeve Rubber sleeve with weather proof
		Hikvision White Stainless Steel 127 mm × 46 mm × 250 mm (5 × 1.81 × 9.84) 1480 g (3.26 lb.)	Hik white Stainless Steel 126×105×250mm 2280g	Hik white Stainless Steel 144 mm × 131.6 mm × 44.3 mm (5.67 × 5.18 × 1.74) 760 g (1.68 lb.)	Hik white Rubber

Product form	Model	Relevant brackets and housings		
	DS-2CD4A26FWD-IZHSY DS-2CD4A35FWD-IZHSY	Outdoor		
				
		DS-1275ZJ-SUS Vertical pole mount	DS-1276ZJ-SUS Corner mount	DS-1275ZJ-S-SUS Vertical pole mount
		Hikvision White Stainless Steel 127 mm × 46 mm × 250 mm (5 × 1.81 × 9.84) 1480 g (3.26 lb.)	Hik white Stainless Steel 126X105X250mm 2280g	Hik white Stainless Steel 144 mm × 131.6 mm × 44.3 mm (5.67 × 5.18 × 1.74) 760 g (1.68 lb.)





Product form	Model	Relevant brackets and housings	
	DS-2CD2085FWD-I DS-2CD2055FWD-I DS-2CD2045FWD-I DS-2CD2025FWD-I DS-2CD2043G0-I DS-2CD2023G0-I	Indoor/Outdoor	
			
		DS-1280ZJ-XS(Black) Junction box	
		Hik Black Aluminum Alloy Φ100 x 43.2 x 129mm 320g	









Product form	Model	Relevant brackets and housings	
	DS-2CD2685FWD-IZS DS-2CD2635FWD-IZS DS-2CD2625FWD-IZS	Indoor/Outdoor	
			
		DS-1475ZJ-SUS(Black) Vertical pole mount	
		Other brackets are the same as Hik white camera Hik Black Stainless Steel 250 mm × 127 mm × 46 mm Diameter of clamp: Φ67-127mm 1205g	





Product form	Model	Relevant brackets and housings	
	DS-2CD5A26G0-IZHSY DS-2CD5A46G0-IZHSY	Indoor/Outdoor	
			
		DS-1475ZJ-Y Vertical pole mount	DS-1476ZJ-Y Corner mount
		Hik white Stainless Steel 250 mm × 127 mm × 46 mm Diameter of clamp: Φ67-127mm 1205g	
		Hik white Stainless Steel 126X105X250mm 2280gww	



Product form	Model	Relevant brackets and housings
	DS-2CD2085FWD-I DS-2CD2055FWD-I DS-2CD2045FWD-I DS-2CD2035FWD-I DS-2CD2025F(H)WD-I DS-2CD2083G0-I DS-2CD2063G0-I DS-2CD2043G0-I DS-2CD2023G0-I DS-2CD3063G0-I DS-2CD3043G0-I DS-2CD3023G0-I DS-2CD3085G0-I DS-2CD3045G0-I DS-2CD3025G0-I	
		DS-1280ZJ-XS Junction box
	DS-2CD2065G1-I DS-2CD2085G1-I DS-2CD2021G1-I(D)(W) DS-2CD2021G1-I(D)(W)(B)	Hik white Aluminum Alloy Φ100 x 43.2 x 129mm 320g
	DS-2CD1001-I DS-2CD1021-I(D) DS-2CD1031-I(D) DS-2CD1013G0-I DS-2CD1023G0-I DS-2CD1043G0-I DS-2CD1053G0-I	
	DS-2CV1021G0-IDW1	
	DS-2CD2051G1-IDW1 DS-2CD2041G1-IDW1 DS-2CD2021G1-IDW1	













Product form	Model	Relevant brackets and housings				
	DS-2CD1621G0-I(Z) DS-2CD1631G0-I(Z) DS-2CD1623G0-I(Z) DS-2CD1643G0-I(Z)	Indoor/Outdoor				
						
	DS-2CD2622FWD-I(Z)(S) DS-2CD2642FWD-I(Z)(S)	DS-1260ZJ Junction box	DS-1280ZJ-S Junction box	DS-1275ZJ-SUS Vertical pole mount	DS-1276ZJ-SUS Corner mount	DS-1275ZJ-S-SUS Vertical pole mount
	DS-2CD2621G0-I(Z)(S)	Hik white Aluminum alloy Φ105 mm	Hik white Aluminum alloy Φ137 x 53.4x 164.8mm 527g	Hikvision White Stainless Steel 127 mm × 46 mm × 250 mm (5" × 1.81" × 9.84") 1480 g (3.26 lb.)	Hik white Stainless Steel 126×105×250mm 2280g	Hik white Stainless Steel 144 mm × 131.6 mm × 44.3 mm (5.67" × 5.18" × 1.74") 760 g (1.68 lb.) Match up with DS- 1260ZJ

Product form	Model	Relevant brackets and housings		
	DS-2CD2685G0-IZS DS-2CD2665G0-IZS DS-2CD2685FWD-IZS(B) DS-2CD2645FWD-IZS DS-2CD2635FWD-IZS DS-2CD2625FWD-IZS DS-2CD2625FHWD-IZS DS-2CD2683G0-IZS DS-2CD2663G0-IZS DS-2CD2643G0-IZS DS-2CD2623G0-IZS DS-2CD3663G0-IZS DS-2CD3643G0-IZS DS-2CD3623G0-IZS DS-2CD3645G0-IZS DS-2CD3625G0-IZS	Indoor/Outdoor		
				
	DS-2CD5A26G0-IZ(H)S DS-2CD5A46G0-IZ(H)S DS-2CD5A85G0-IZ(H)S DS-2CD5AC5G0-IZ(H)S DS-2CD7A26G0(P)-IZ(H)S DS-2CD7A46G0(P)-IZ(H)S DS-2CD7A85G0-IZ(H)S	DS-1475ZJ-SUS Vertical pole mount	DS-1476ZJ-SUS Corner mount	DS-1275ZJ-S-SUS Vertical pole mount
		Hik white Stainless Steel 250 mm × 127 mm × 46 mm Diameter of clamp: Φ67-127mm 1205g	Hik white Stainless Steel 126×105×250mm 2280g	Hik white Stainless Steel 144 mm × 131.6 mm × 44.3 mm (5.67" × 5.18" × 1.74") 760 g (1.68 lb.)









Product form	Model	Relevant brackets and housings				
	DS-2CD2T42WD-I3/I5/I8 DS-2CD2T22WD-I3/I5/I8 DS-2CD2T85FWD-I5/I8 DS-2CD2T55FWD-I5/I8 DS-2CD2T45FWD-I5/I8 DS-2CD2T35FWD-I5/I8 DS-2CD2T25FWD-I5/I8 DS-2CD2T25FHWD-I5/I8 DS-2CD2T83G0-I5/I8 DS-2CD2T63G0-I5/I8 DS-2CD2T43G0-I5/I8 DS-2CD2T23G0-I5/I8 DS-2CD3T63G0-I5/I8 DS-2CD3T43G0-I5/I8 DS-2CD3T23G0-I5/I8 DS-2CD3T45G0-I DS-2CD3T25G0-I	Indoor/Outdoor				
						
	DS-2CD2T85G1-I5/I8 DS-2CD2T65G1-I5/I8 DS-2CD2T26G1-2I/4I DS-2CD2T46G1-2I/4I	DS-1275ZJ-SUS Vertical pole mount	DS-1260ZJ Junction box	DS-1276ZJ-SUS Corner mount	DS-1280ZJ-S Junction box	DS-1275ZJ-S-SUS Vertical pole mount
	DS-2CD2685G1-IZ(S) DS-2CD2665G1-IZ(S) DS-2CD2645G1-IZ(S) DS-2CD2625G1-IZ(S) DS-2CD2646G1-IZ(S) DS-2CD2626G1-IZ(S)	Hikvision White Stainless Steel 127 mm × 46 mm × 250 mm (5" × 1.81" × 9.84") 1480 g (3.26 lb.)		Hik white Aluminum alloy Φ105 mm included in the package with 3TXX series		Hik white Stainless Steel 126×105×250mm 2280g
	DS-2CD2683G1-IZ(S) DS-2CD2663G1-IZ(S) DS-2CD2643G1-IZ(S) DS-2CD2623G1-IZ(S)	Hik white Stainless Steel 144 mm × 131.6 mm × 44.3 mm (5.67" × 5.18" × 1.74") 760 g (1.68 lb.) Match up with DS-1260ZJ				

Product form	Model	Relevant brackets and housings Indoor/Outdoor		
	DS-2CD2T85FWD-18 DS-2CD2T55FWD-18 DS-2CD2T35FWD-18 DS-2CD2T25FWD-18			
		DS-1275ZJ-SUS[Black] Vertical pole mount	DS-1260ZJ[Black] Junction box	DS-1276ZJ-SUS[Black] Corner mount
		Hik Black Stainless Steel 127×46×250mm Diameter of clamp: Ø67-127mm 1480g	Hik Black Aluminum alloy Ø105 mm	Hik Black Stainless Steel 126×105×250mm 2280g

Product form	Model	Relevant brackets and housings Indoor/ Outdoor	
	DS-2CD2042WD-1 DS-2CD2022WD-1		
		DS-1280ZJ-S Junction box	
		Hik white Aluminum alloy Ø137 x 53.4x 164.8mm 527g	













Product form	Model	Relevant brackets and housings Indoor/Outdoor										
	DS-2CD2T21G0-IS											
		DS-1296ZJ Wall mount	DS-1292ZJ Wall mount	DS-1203ZJ Pendant Mount	DS-1297ZJ Pendant Mount	DS-1214ZJ-T Horizontal pole mount	DS-1275ZJ-SUS Vertical pole mount	DS-1276ZJ-SUS Corner mount	DS-1232ZJ Cardan Joint	DS-1232ZJ-T Cardan Joint	DS-1297ZJ-ES Pendant mount (extendable)	DS-1297ZJ-M Pendant mount (extendable)
		Hik white Plastic 70x79.1x196.5mm Included in the package	Hik white Aluminum alloy 70x97.1x217.9mm 201g	Hik white 70.4x84 x200.5mm 220g	Hik white Aluminum Alloy Ø120x200mm 1035g	Hik white Steel(mounting board) & Stain- less Steel(clamp) 194 mm x 117 mm x 138.5 mm (7.64" x 4.61" x 5.45") 1900 g (4.19 lb.)	Hikvision White Stainless Steel 127 mm x 46 mm x 250 mm (5" x 1.81" x 9.84") 1480 g (3.26 lb.) Match up with wall mount(DS- 1292ZJ-XX[B])	Hik white Stainless Steel 126×105×250mm 2280g Match up with wall mount(DS- 1292ZJ-XX[B])	Hik white Steel 126x103.5x83mm 790	Hik white Steel 96x95x92.5mm	Hikvision White Aluminum Alloy Ø 97 mm x 270 mm to 400 mm (Ø 3.82" x 10.63" to 15.75") 500 g (1.10 lb.)	Hikvision White Aluminum Alloy Ø 120 mm x 650 mm to 1200 mm (Ø 4.72" x 25.59" to 47.24") 800 g (1.76 lb.)

Product form	Model	Relevant brackets and housings Indoor/ Outdoor
	DS-2CD4625FWD-IZ(H)(S) DS-2CD4635FWD-IZ(H)(S) DS-2CD4665F-IZ(H)(S) DS-2CD4685F-IZ(H)(S) DS-2CD4626FWD-IZ(H)(S)	
		DS-1275ZJ-4626 Vertical Pole Mount
	DS-2CD8626G0/P-IS	Hik white Steel(mounting board) & Stainless Steel(clamp) 127×46×250mm 1235g

Product form	Model	Relevant brackets and housings Indoor						
	DS-2CD7126G0-IZS DS-2CD7126G0/L-IZS DS-2CD7146G0-IZS DS-2CD7185G0-IZS DS-2CD5126G0-IZS DS-2CD5146G0-IZS DS-2CD5185G0-IZS DS-2CD51C5G0-IZS							
		DS-1271ZJ-130 Pendant Mount	DS-1273ZJ-130 Wall mount	DS-1273ZJ-130B Wall mount	DS-1227ZJ In-ceiling mount	DS-1275ZJ-SUS Vertical pole mount	DS-1276ZJ-SUS Corner mount	DS-1281ZJ-DM23 Inclined ceiling mount
	DS-2CD4125FWD-IZ DS-2CD4126FWD-IZ DS-2CD4135FWD-IZ DS-2CD4165F-IZ DS-2CD4185F-IZ DS-2CD41C5F-IZ	Hik white Aluminum alloy Ø150×565mm 1900g	Hik white Aluminum alloy 132×183.5 ×288.5mm 690g	Hik white Aluminum alloy with junction box 132×243 ×288.5mm 1475g	Hik white Aluminum alloy & ABS Plastic Ø210×90mm 540g	Hik white Stainless Steel 127×46×250mm Diameter of clamp: Ø67- 127mm 1205g Match up with wall mount(DS- 1273ZJ-130)	Hik white Stainless Steel 126X105X250mm 2280g Match up with wall mount(DS- 1273ZJ-130)	Hik white Aluminum alloy Ø136×48mm 245g







Product form	Model	Relevant brackets and housings Indoor/Outdoor						
	DS-2CD2522FWD-I(W)(S) DS-2CD2542FWD-I(W)(S) DS-2XM6112FWD-I(M)							
		DS-1272ZJ-120 Wall mount	DS-1272ZJ-120B Wall mount	DS-1271ZJ-120 Pendant mount	DS-1276ZJ-SUS Corner mount	DS-1282ZJ-DM(mini) Gang box	DS-1280ZJ-DM46 Junction box	DS-1275ZJ-SUS Vertical pole mount
		Hik white Aluminum alloy 120×122×173.5mm 430g	Hik white Aluminum alloy with junction box 123×180×223mm 1225g	Hik white Aluminum alloy Ø150×573mm 1900g	Hik white Stainless Steel 126X105X250mm 2280g Match up with wall mount(DS-1272ZJ-XX[B])	Hik white Plastic Ø120 mm (comes with camera)	Hik white Aluminum alloy Ø 120 mm x 37.2 mm (Ø 4.72" x 1.46") 250g	Hikvision White Stainless Steel 127 mm x 46 mm x 250 mm (5" x 1.81" x 9.84") 1480 g (3.26 lb.) Match up with wall mount(DS-1272ZJ-XX[B])
	DS-2CD2555FWD-I(W)(S) DS-2CD2545FWD-I(W)(S) DS-2CD2535FWD-I(W)(S) DS-2CD2525FWD-I(W)(S) DS-2CD2525FHWI-I(W)(S) DS-2CD2563G0--I(W)(S) DS-2CD2543G0--I(W)(S) DS-2CD2523G0--I(W)(S) DS-2CD3563G0-IS DS-2CD3543G0-IS DS-2CD3523G0-IS DS-2CD3565G0-IS DS-2CD3545G0-IS DS-2CD3525G0-IS DS-2XM6726FWD-I(S)(M) DS-2XM6726FWD-IM/ND DS-2XM6736FWD-I(S)(M) DS-2XM6736FWD-IM/ND DS-2XM6756FWD-I(S)(M) DS-2XM6756FWD-IM/ND							





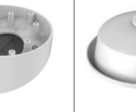
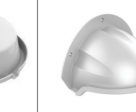

Product form	Model	Relevant brackets and housings Indoor/Outdoor				
	DS-2CD2545FWD-IS DS-2CD2525FWD-IS DS-2CD2563G0--I(S) DS-2CD2543G0--I(S) DS-2CD2523G0--I(S)					
		DS-1272ZJ-120(Black) Wall mount	DS-1271ZJ-120(Black) Pendant mount	DS-1276ZJ-SUS(Black) Corner mount	DS-1280ZJ-DM46(Black) Junction box	DS-1275ZJ-SUS(Black) Vertical pole mount
		Hik Black Aluminum alloy 120×122×173.5mm 430g	Hik Black Aluminum alloy Ø150×573mm 1900g	Hik Black Stainless Steel 126X105X250mm 2280g Match up with wall mount(DS- 1272ZJ-XX(B))	Hik Black Aluminum alloy Ø 120 mm x 37.2 mm (Ø 4.72" x 1.46") 250g	Hik Black Stainless Steel 127 mm x 46 mm x 250 mm (5" x 1.81" x 9.84") 1480 g (3.26 lb.) Match up with wall mount(DS- 1272ZJ-XX(B))
		Other brackets are the same as Hik white camera				

Product form	Model	Relevant brackets and housings									
		Indoor/Outdoor(suitable for indoor)									
	DS-2CD1101-I DS-2CD1121-I(D) DS-2CD1131-I(D) DS-2CD11360-I DS-2CD112360-I DS-2CD114360-I										
	DS-2CD2122FWD-I(W)(S) DS-2CD2142FWD-I(W)(S)	Inclined ceiling mount	Pendant mount	Wall mount	Wall mount	Corner mount	Junction box	Wall mount	Vertical pole mount	Rain shade	Rain shade
	DS-2CD2165G0-I(S) DS-2CD2185FWD-I(S) DS-2CD2155FWD-I(S) DS-2CD2145FWD-I(S) DS-2CD2135FWD-I(S) DS-2CD2125FWD-I(S) DS-2CD2125FHWI-I(S) DS-2CD2083G0-I(S) DS-2CD2063G0-I(S) DS-2CD2043G0-I(S) DS-2CD2023G0-I(S) DS-2CD3163G0-I(S) DS-2CD3143G0-I(S) DS-2CD3123G0-I(S) DS-2CD3185G0-I DS-2CD3145G0-I DS-2CD3125G0-I	Hik white ABS Plastic Ø111×39.2mm 200g	Hik white Aluminum alloy Ø150×560mm 1900g	Hik white Aluminum alloy 120×122×169mm 420g	Hik white Aluminum alloy with junction box 123×180×227.8mm 1205g	Hik white Stainless Steel 126X105X250mm 2280g Match up with wall mount(DS-1272ZJ- XX(B))	Hik white Aluminum alloy Ø115.4×43.8mm 450g	Hik white ABS plastic 120×111×161.5mm 200g	Hikvision White Stainless Steel 127 mm × 46 mm × 250 mm (5" × 1.81" × 9.84") 1480 g (3.26 lb.) Match up with wall mount(DS-1272ZJ- XX(B))	Hik white Composite Fibre Ø191.1×76mm 133g Match up with wall mount(DS- 1272ZJ-110)	Hik white Composite Fibre 264.7*152*189.6 mm 199g

Product form	Model	Relevant brackets and housings									
		Indoor/Outdoor(suitable for indoor)									
	DS-2CD2185FWD-I DS-2CD2155FWD-I DS-2CD2145FWD-I(S) DS-2CD2125FWD-I DS-2CD2183G0-I(S) DS-2CD2163G0-I(S) DS-2CD2143G0-I(S) DS-2CD2123G0-I(S)										
		Inclined ceiling mount	Pendant mount	Wall mount	Wall mount	Corner mount	Junction box	Wall mount	Rain shade	Vertical pole mount	
		Hik Black ABS Plastic Ø111×39.2mm 200g	Hik Black Aluminum alloy Ø150×560mm 1900g	Hik Black Aluminum alloy 120×122×169mm 420g	Hik Black Aluminum alloy with junction box 123×180×227.8mm 1205g	Hik Black Stainless Steel 126X105X250mm 2280g Match up with wall mount(DS-1272ZJ- XX(B))	Hik Black Aluminum alloy Ø115.4×43.8mm 450g	Hik Black ABS plastic 120×111×161.5mm 200g	Hik Black Composite Fibre 264.7*152*189.6 mm 199g	Hik Black Stainless Steel 127×46×250mm Diameter of clamp: Ø67-127mm 1480g Match up with wall mount(DS-1272ZJ- XX(B))	





Product form	Model	Relevant brackets and housings					
		Indoor/Outdoor					
	DS-2CD2146G1-I(S) DS-2CD2126G1-I(S)						
		DS-1272ZJ-120	DS-1272ZJ-120B	DS-1271ZJ-120	DS-1276ZJ-SUS	DS-1275ZJ-SUS	DS-1253ZJ-M
		Wall mount	Wall mount	Pendant mount	Corner mount	Vertical pole mount	Rain Shade for Outdoor Dome Camera
		Hik white Aluminum alloy 120×122×173.5mm 430g	Hik white Aluminum alloy with junction box 123×180×223mm 1225g	Hik white Aluminum alloy Ø150×573mm 1900g	Hik white Stainless Steel 126X105X250mm 2280g Match up with wall mount(DS- 1272ZJ-XX(B))	Hikvision White Stainless Steel 127 mm × 46 mm × 250 mm (5" × 1.81" × 9.84") 1480 g (3.26 lb.) Match up with wall mount(DS- 1272ZJ-XX(B))	Hikvision White PP+30%GF Ø191.1×76mm 133g





Product form	Model	Relevant brackets and housings											
		Indoor/Outdoor											
	DS-2CD1721F- WD-I(Z)(B) DS-2CD1731F- WD-I(Z)(B) DS-2CD1723G0- I(Z) DS-2CD1743G0- I(Z)												
		DS-1271ZJ-135	DS-1273ZJ-135	DS-1273ZJ-135B	DS-1275ZJ-SUS	DS-1276ZJ-SUS	DS-1227ZJ	DS-1280ZJ-DM21	DS-1281ZJ-DM23	DS-1253ZJ-L	DS-1250ZJ	DS-1258ZJ-L	D20-AP
		Pendant mount	Wall mount	Wall mount with junction box	Vertical pole mount	Corner mount	In-ceiling mount	Junction box	Inclined ceiling mount	Rain shade	Rain shade	Wall mount	Adapter Plate
	DS-2CD2722F- WD-I(Z)(S) DS-2CD2742F- WD-I(Z)(S)	Hik white Aluminum alloy 150×150× 565mm 1900g	Hik white Aluminum alloy 136×183.5× 230mm 704g	Hik white Aluminum alloy with junction box 136×243× 290mm 1490g	Hik white Stainless Steel 127×46×250mm Diameter of clamp: Ø67- 127mm 1205g Match up with wall mount(DS- 1273ZJ-135)	Hik white Stainless Steel 126x 105x 250mm 2280g Match up with wall mount(DS- 1273ZJ-135)	Hik white Aluminum alloy & ABS Plastic Ø210×90mm 540g	Hik white Aluminum alloy 162×137×42mm 250g	Hik white Aluminum alloy 136.3×136.3× 48mm 245g	Hik white Composite Fibre Ø225.1×98mm 198g Match up with wall mount (DS- 1273ZJ-135)	Hik white Composite Fibre 264.7x 152x 189.6 mm 199g	Hik white Plastic 136×183×213mm 260g	Hik white Match up with DS-1227ZJ for 17XX models





Product form	Model	Relevant brackets and housings					
		Indoor/Outdoor					
	DS-2CD2785G0-I(ZS) DS-2CD2765G0-I(ZS) DS-2CD2785FWD-I(ZS) DS-2CD2755FWD-I(ZS)(B) DS-2CD2745FWD-I(ZS) DS-2CD2735FWD-I(ZS) DS-2CD2725FWD-I(ZS) DS-2CD2725FHWI-I(ZS) DS-2CD2783G0-I(ZS) DS-2CD2763G0-I(ZS) DS-2CD2743G0-I(ZS) DS-2CD2723G0-I(ZS) DS-2CD3763G0-I(ZS) DS-2CD3743G0-I(ZS) DS-2CD3723G0-I(ZS) DS-2CD3745G0-I(ZS)						
		DS-1471ZJ-155	DS-1473ZJ-155	DS-1475ZJ-SUS	DS-1476ZJ-SUS	DS-1227ZJ-DM37	DS-1473ZJ-155B
		Pendant Mount	Wall Mount	Vertical pole mount	Corner mount	In-Ceiling Mount	Wall Mount
		Hik white Aluminum alloy Ø155×150×565mm	Hik white Aluminum alloy 155×183.5×240mm	Hik white Stainless Steel 250 mm × 127 mm × 46 mm Diameter of clamp: Ø67-127mm 1205g Match up with wall mount(DS- 1473ZJ-XX(B))	Hik white Stainless Steel 126X105X250mm 2280g Match up with wall mount(DS- 1473ZJ-XX(B))	Hik white Steel and Plastic Ø 225 mm × 98.2 mm (8.86" × 3.87") 700 g (1.54 lb.)	Hik white Aluminum alloy 243×123×300mm 1750 g (3.86 lb.)









Product form	Model	Relevant brackets and housings Indoor/Outdoor				
	DS-2CD2785FWD-IZS DS-2CD2735FWD-IZS DS-2CD2725FWD-IZS					Other brackets are the same as Hik white camera
		DS-1471ZJ-155(Black) Pendant Mount	DS-1473ZJ-155(Black) Wall Mount	DS-1475ZJ-SUS(Black) Vertical pole mount	DS-1473ZJ-155B(Black) Wall Mount	
		Hik Black Aluminum alloy Φ155×150×565mm	Hik Black Aluminum alloy 155×183.5×240mm	Hik white Stainless Steel 250 mm × 127 mm × 46 mm Diameter of clamp: Φ67-127mm 1205g Match up with wall mount(DS-1473ZJ-XX(B))	Hik Black Aluminum alloy 243×123×300mm 1750 g (3.86 lb.)	





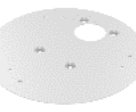

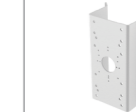
Product form	Model	Relevant brackets and housings Indoor/Outdoor					
	DS-2CD2721G0-I(Z)(S)						
	DS-2CD2785G1-IZS DS-2CD2765G1-IZS DS-2CD2745G1-IZS DS-2CD2725G1-IZS DS-2CD2783G1-IZS DS-2CD2763G1-IZS DS-2CD2743G1-IZS DS-2CD2723G1-IZS DS-2CD2746G1-IZS DS-2CD2726G1-IZS	DS-1471ZJ-155 Pendant Mount	DS-1473ZJ-155 Wall Mount	DS-1475ZJ-SUS Vertical pole mount	DS-1476ZJ-SUS Corner mount	DS-1280ZJ-DM55 Junction Box	DS-1473ZJ-155B Wall Mount
		Hik white Aluminum alloy Φ155×150×565mm	Hik white Aluminum alloy 155×183.5×240mm	Hik white Stainless Steel 250 mm × 127 mm × 46 mm Diameter of clamp: Φ67-127mm 1205g Match up with wall mount(DS-1473ZJ-XX(B))	Hik white Stainless Steel 126X105X250mm 2280g Match up with wall mount(DS-1473ZJ-XX(B))	Hikvision White Aluminum Alloy Φ 155 mm × 36 mm (Φ 6.1" × 1.42") 300 g (0.66 lb.)	Hik white Aluminum alloy 243×123×300mm 1750 g (3.86 lb.)









Product form	Model	Relevant brackets and housings Indoor/Outdoor				
	DS-2CD2783G1-IZS DS-2CD2763G1-IZS DS-2CD2743G1-IZS DS-2CD2723G1-IZS					Other brackets are the same as Hik white camera
		DS-1273ZJ-155(Black) Wall Mount	DS-1275ZJ-SUS(Black) Vertical pole mount	DS-1276ZJ-SUS(Black) Corner mount	DS-1280ZJ-DM55(Black) Junction Box	
		Hik Black Aluminum alloy 155×183.5×240mm	Hik Black Stainless Steel 250 mm × 127 mm × 46 mm Diameter of clamp: Φ67-127mm 1480g Match up with wall mount(DS-1273ZJ-XX(B))	Hik Black Stainless Steel 126X105X250mm 2280g Match up with wall mount(DS-1273ZJ-XX(B))	Hik Black Aluminum Alloy Φ 155 mm × 36 mm (Φ 6.1" × 1.42") 300 g (0.66 lb.)	

Product form	Model	Relevant brackets and housings Indoor/Outdoor		
	DS-2CD4526F-WD-IZHY DS-2CD4535F-WD-IZHY			
		DS-1273ZJ-DM26-Y Wall mount	DS-1275ZJ-SUS Vertical pole mount	DS-1276ZJ-SUS Corner mount
		Hik white Stainless Steel 255×225.7×185mm	Hik white Stainless Steel 127×46×250mm Diameter of clamp: Φ67-127mm 1205g Match up with wall mount()	Hik white Stainless Steel 126X105X250mm 2280g Match up with wall mount()











Product form	Model	Relevant brackets and housings Indoor/Outdoor			
	DS-2CD5526G0-IZ(H)SY DS-2CD5546G0-IZ(H)SY				
		DS-1471ZJ-155-Y Pendant Mount	DS-1473ZJ-155-Y Wall Mount	DS-1475ZJ-Y Vertical pole mount	DS-1476ZJ-Y Corner mount
		Hik white Aluminum alloy Φ155×150×565mm	Hik white Aluminum alloy 155×183.5×240mm	Hik white Stainless Steel 250 mm × 127 mm × 46 mm Diameter of clamp: Φ67-127mm 1205g Match up with wall mount(DS-1473ZJ-155-Y)	Hik white Stainless Steel 126X105X250mm 2280g Match up with wall mount(DS-1473ZJ-155-Y)

Product form	Model	Relevant brackets and housings Indoor/Outdoor							
	DS-2CD4525FWD-IZ(H) DS-2CD4526FWD-IZ(M)(H) DS-2CD4535FWD-IZ(H) DS-2CD4565F-IZ(H) DS-2CD4585F-IZ(H) DS-2CD45C5F-IZ(H)								
		DS-1273ZJ-DM26 Wall mount	DS-1273ZJ-DM26-B Wall mount with junction box	DS-1271ZJ-DM26 Pendant mount	GP-FE1 Gang box for junction box (special for US market)	DS-1250ZJ Rain shade	DS-1275ZJ-SUS Vertical pole mount	DS-1276ZJ-SUS Corner mount	DS-1227ZJ-DM26 In-ceiling Mount
		Hik white Aluminum alloy 255×225.7×185mm 1550g	Hik white Aluminum alloy 314.5×260×184.9mm 2050g	Hik white Aluminum alloy 676×185×185mm 2150g	Hik white Steel Φ195mm	Hik white Composite Fibre 264.7*152*189.6 mm 199g	Hikvision White Stainless Steel 127 mm × 46 mm × 250 mm (5" × 1.81" × 9.84") 1480 g (3.26 lb.) Match up with wall mount(DS-1273ZJ-XX(B))	Hik white Stainless Steel 126X105X250mm 2280g Match up with wall mount(DS-1273ZJ-XX(B))	Hik white Aluminum alloy Φ225×98mm









Product form	Model	Relevant brackets and housings Indoor/Outdoor				
	DS-2CD4016FWD-IZ(S) DS-2CD4026FWD-IZ(S) DS-2CD4036FWD-IZ(S)					
		DS-1273ZJ-DM32 Wall mount	DS-1271ZJ-DM32 Pendant mount	DS-1275ZJ-SUS Vertical pole mount	DS-1276ZJ-SUS Corner mount	DS-1227ZJ-DM32 In-ceiling Mount
		Hikvision white Aluminum alloy 183.5×142×232mm	Hikvision white Aluminum alloy Φ150×565mm	Hikvision White Stainless Steel 127 mm × 46 mm × 250 mm (5" × 1.81" × 9.84") 1480 g (3.26 lb.) Match up with wall mount(DS-1273ZJ-XX(B))	Hik white Stainless Steel 126X105X250mm 2280g Match up with wall mount(DS-1273ZJ-XX(B))	Hik white Aluminum alloy Φ225×98mm





Product form	Model	Relevant brackets and housings						
		Indoor/Outdoor						
	DS-2CD5526G0-IZ(H)S DS-2CD5546G0-IZ(H)S DS-2CD5585G0-IZ(H)S DS-2CD55C5G0-IZ(H)S DS-2CD7526G0-IZ(H)S DS-2CD7546G0-IZ(H)S DS-2CD7585G0-IZ(H)S							
		DS-1471ZJ-155 Pendant Mount	DS-1473ZJ-155 Wall Mount	DS-1475ZJ-SUS Vertical pole mount	DS-1476ZJ-SUS Corner mount	DS-1473ZJ-155B Wall Mount	DS-1253ZJ-L Rain shade	DS-1250ZJ Rain shade
		Hik white Aluminum alloy Ø155×150×565mm	Hik white Aluminum alloy 155×183.5×240mm	Hik white Stainless Steel 250 mm × 127 mm × 46 mm Diameter of clamp: Ø67- 127mm 1205g Match up with wall mount(DS-1473ZJ-XX(B))	Hik white Stainless Steel 126X105X250mm 2280g Match up with wall mount(DS-1473ZJ-XX(B))	Hik white Aluminum alloy 243×123×300mm 1750 g (3.86 lb.)	Hik white Composite Fibre Ø225.1×98mm 198g Match up with wall mount(DS-1473ZJ-155)	Hik white Composite Fibre 264.7*152*189.6 mm 199g

Product form	Model	Relevant brackets and housings					
		Indoor					
	DS-2CD2935FWD-IS DS-2CD2955FWD-IS						
		DS-1294ZJ Wall mount	DS-1281ZJ-DM27 Inclined ceiling mount	DS-1297ZJ Pendant mount (extendable)	DS-1299ZJ Pendant Mount	DS-1297ZJ-ES Pendant mount (extendable)	DS-1297ZJ-M Pendant mount (extendable)
		"Hik white Toughened Plastic 223.9×80×125.8mm 450g"	"Hik white Plastic 111.8×40.5×108.3mm 45.8g "	"Hik white Aluminum alloy (Hight 1000-2000mm)"	"Hik white Aluminum Alloy 77×77×198mm 165g "	"Hikvision White Aluminum Alloy Ø 97 mm × 270 mm to 400 mm (Ø 3.82" × 10.63" to 15.75") 500 g (1.10 lb.)"	"Hikvision White Aluminum Alloy Ø 120 mm × 650 mm to 1200 mm (Ø 4.72" × 25.59" to 47.24") 800 g (1.76 lb.)"

Product form	Model	Relevant brackets and housings								
		Indoor/Outdoor								
	DS-2CD632F-IV(S) DS-2CD632F-WD-IV(S) DS-2CD632F-IV(S)									
		DS-1271ZJ-DM25 Pendant mount	DS-1273ZJ-DM25 Wall mount	DS-1280ZJ-DM25 Junction box	DS-1281ZJ-DM25 Inclined ceiling mount	DS-1283ZJ Three axis adjustment	DS-1275ZJ-SUS Vertical pole mount	DS-1276ZJ-SUS Corner mount	DS-1274ZJ-DM25 Corner mount	DS-1281ZJ-DM25-B Pendant mount
		Hik white Aluminum alloy Ø149.5×555mm 1930g	Hik white Aluminum alloy 183.5×164×231.7mm 900g	Hik white Aluminum alloy 178.5×164×41mm 340g	Hik white Aluminum alloy 157.1×164×45.5mm 300g	Hik white Aluminum alloy 167.5×167.5×48.7mm	Hikvision White Stainless Steel 127 mm × 46 mm × 250 mm (5" × 1.81" × 9.84") 1480 g (3.26 lb.) Match up with wall mount(DS-1283ZJ,DS- 1273ZJ-XX(B))	Hik white Stainless Steel 126X105X250mm 2280g Match up with wall mount(DS-1283ZJ,DS- 1273ZJ-XX(B))	Hik white Aluminum alloy 209×195×114mm	Hik white Aluminum alloy 161×156×165.5mm

Product form	Model	Relevant brackets and housings							
		Indoor/Outdoor							
	DS-2CD6362F-IV(S) DS-2CD6332FWD-IV(S)								
		DS-1271ZJ-DM25(M1) Pendant mount	DS-1273ZJ-DM25(M1) Wall mount	DS-1280ZJ-DM25(M1) Junction box	DS-1281ZJ-DM25(M1) Inclined ceiling mount	DS-1283ZJ-DM25(M1) Three axis adjustment	GP-FE1 Gang box for junction box (special for US market)	DS-1276ZJ-SUS Corner mount	DS-1275ZJ-SUS Vertical pole mount
		Hik white Aluminum alloy 585×178.7×178.7mm 1730g	Hik white Aluminum alloy 251.9×178.7×183.5mm 1105g	Hik white Aluminum alloy 167.5×167.5×42mm 362g	Hik white Aluminum alloy 167.5×174.6×46.6mm 326g	Hik white Aluminum alloy 167.5×167.5×48.7mm	Hik white Steel Ø195mm	Hik white Stainless Steel 126X105X250mm 2280g Match up with wall mount(DS-1283ZJ-XX- (B),DS-1273ZJ-XX(B))	Hikvision White Stainless Steel 127 mm × 46 mm × 250 mm (5" × 1.81" × 9.84") 1480 g (3.26 lb.) Match up with wall mount(DS-1283ZJ-XX- (B),DS-1273ZJ-XX(B))

Product form	Model	Relevant brackets and housings							
		Indoor/Outdoor							
	DS-2CD2342WD-I DS-2CD2322WD-I								
		DS-1273ZJ-130-TRL Wall mount	DS-1275ZJ-SUS Vertical pole mount	DS-1276ZJ-SUS Corner mount	DS-1280ZJ-DM8 Junction box	DS-1281ZJ-M Inclined ceiling mount	DS-1271ZJ-130-TRL Pendant mount	DS-1273ZJ-130B-TRL Wall mount	
		Hik white Aluminum alloy 131×183.5×228.5mm 890g	Hikvision White Stainless Steel 127 mm × 46 mm × 250 mm (5" × 1.81" × 9.84") 1480 g (3.26 lb.) Match up with wall mount(DS-1273ZJ-XX(B))	Hik white Stainless Steel 126X105X250mm 2280g Match up with wall mount(DS-1273ZJ-J-XX(B))	Hik white Aluminum alloy Ø126.7mm×35mm	Hik white Aluminum alloy 157×165.7×61.8mm 586g	Hikvision white Aluminum alloy Ø150×567mm	Hikvision White Aluminum Alloy Ø 132 mm × 242.9 mm × 288.5mm (5.20" × 9.56" × 11.36") 1690 g (3.73 lb.)	





Product form	Model	Relevant brackets and housings		
		Indoor/Outdoor		
	DS-2CD2346G1-I DS-2CD2326G1-I			
		DS-1271ZJ-140 Pendant Mount	DS-1273ZJ-140 Wall mount	DS-1280ZJ-DM21 Junction box
		Hik white Aluminum alloy Ø150×565mm 1900g	Hik white Aluminum alloy 140×183.5×232mm 703g	Hik white Aluminum alloy 162×137×42mm 250g





Product form	Model	Relevant brackets and housings						Other brackets are the same as Hik white camera
Indoor/Outdoor								
	DS-2CD2385FWD-I DS-2CD2355FWD-I DS-2CD2345FWD-I DS-2CD2325FWD-I DS-2CD2383G0-I DS-2CD2363G0-I DS-2CD2343G0-I DS-2CD2323G0-I							
		DS-1273ZJ-130-TRL(Black) Wall mount	DS-1275ZJ-SUS(Black) Vertical pole mount	DS-1276ZJ-SUS(Black) Corner mount	DS-1280ZJ-DM8(Black) Junction box	DS-1281ZJ-M(Black) Inclined ceiling mount	DS-1271ZJ-130-TRL(Black) Pendant mount	
		Hik Black Aluminum alloy 131×183.5×228.5mm 890g	Hik Black Stainless Steel 250 mm × 127 mm × 46 mm Diameter of clamp: Ø67-127mm 1480g Match up with wall mount(DS-1273ZJ-XX(B))	Hik Black Stainless Steel 126X105X250mm 2280g Match up with wall mount(DS-1273ZJ-J-XX(B))	Hik Black Aluminum alloy Ø126.7mm×35mm	Hik Black Aluminum alloy 157×165.7×61.8mm 586g	Hik Black Aluminum alloy Ø150×567mm	



Product form	Model	Relevant brackets and housings					
Indoor/Outdoor							
	DS-2CD232160-I/NF						
		DS-1272ZJ-110 Wall mount	DS-1275ZJ-SUS Vertical pole mount	DS-1276ZJ-SUS Corner mount	DS-1280ZJ-S Junction box	DS-1281ZJ-S Inclined ceiling mount	DS-1271ZJ-110 Pendant mount
		Hik white Aluminum alloy 120×122×169mm 420g	Hik white Stainless Steel 127×46×250mm Diameter of clamp: Ø67-127mm 1205g Match up with wall mount (DS-1272ZJ-110)	Hik white Stainless Steel 126X105X250mm 2280g Match up with wall mount (DS-1272ZJ-110)	Hik white Aluminum alloy 137×53.4×164.8mm 527g	Hik white Aluminum alloy 137×56.5×147mm 472g	Hik white Aluminum alloy Ø150×560mm 1900g



Product form	Model	Relevant brackets and housings						
Indoor/Outdoor								
	DS-2CD2H85FWD-IZS DS-2CD2H55FWD-IZS(B) DS-2CD2H45FWD-IZS DS-2CD2H35FWD-IZS DS-2CD2H25FWD-IZS DS-2CD2H25FHWD-IZS DS-2CD2H83G0-IZS DS-2CD2H63G0-IZS DS-2CD2H43G0-IZS DS-2CD2H23G0-IZS DS-2CD3H63G0-IZS DS-2CD3H43G0-IZS DS-2CD3H23G0-IZS DS-2CD3H45G0-IZS DS-2CD3H25G0-IZS							
		DS-1473ZJ-135 Wall mount	DS-1471ZJ-135 Pendant mount	DS-1281ZJ-DM23 Inclined ceiling mount	DS-1475ZJ-SUS Vertical pole mount	DS-1476ZJ-SUS Corner mount	DS-1473ZJ-135B Wall mount with junction box	
		Hik white Aluminum alloy 136×183.5×230mm 704g	Hik white Aluminum alloy 150×150×565mm 1900g	Hik white Aluminum alloy 136.3×136.3×48mm 245g	Hik white Stainless Steel 250 mm × 127 mm × 46 mm Diameter of clamp: Ø67-127mm 1205g Match up with wall mount(DS-1473ZJ-XX(B))	Hik white Stainless Steel 126X105X250mm 2280g Match up with wall mount(DS-1473ZJ-XX(B))	Hik white Aluminum alloy with junction box 136×243×290mm 1490g	

Product form	Model	Relevant brackets and housings				Other brackets are the same as Hik white camera
Indoor/Outdoor						
	DS-2CD2H85FWD-IZS DS-2CD2H35FWD-IZS DS-2CD2H25FWD-IZS					
		DS-1473ZJ-135(Black) Wall mount	DS-1471ZJ-135(Black) Pendant mount	DS-1281ZJ-DM23(Black) Inclined ceiling mount	DS-1475ZJ-SUS(Black) Vertical pole mount	
		Hik Black Aluminum alloy 136×183.5×230mm 704g	Hik Black Aluminum alloy 150×150×565mm 1900g	Hik Black Aluminum alloy 136.3×136.3×48mm 245g	Hik Black Stainless Steel 250 mm × 127 mm × 46 mm Diameter of clamp: Ø67-127mm 1205g Match up with wall mount(DS-1473ZJ-XX(B))	

Product form	Model	Relevant brackets and housings							
Indoor/Outdoor									
	DS-2CD1H21WD-IZ DS-2CD1H31WD-IZ DS-2CD1H41WD-IZ								
		DS-1273ZJ-130-TRL Wall mount	DS-1275ZJ-SUS Vertical pole mount	DS-1276ZJ-SUS Corner mount	DS-1280ZJ-M Junction box	DS-1281ZJ-M Inclined ceiling mount	DS-1271ZJ-130-TRL Pendant mount	DS-1273ZJ-130B-TRL Wall mount	
		Hik white Aluminum alloy 131×183.5×228.5mm 890g	Hikvision White Stainless Steel 127 mm × 46 mm × 250 mm (5" × 1.81" × 9.84") 1480 g (3.26 lb.) Match up with wall mount(DS-1273ZJ-XX(B))	Hik white Stainless Steel 126X105X250mm 2280g Match up with wall mount(DS-1273ZJ-XX(B))	Hik white Aluminum alloy 157×184.8×53.4mm 621g	Hik white Aluminum alloy 157×165.7×61.8mm 586g	Hikvision white Aluminum alloy Ø150×567mm	Hikvision White Aluminum Alloy Ø 132 mm × 242.9 mm × 288.5mm (5.20" × 9.56" × 11.36") 1690 g (3.73 lb.)	

Product form	Model	Relevant brackets and housings			
Indoor/Outdoor					
	DS-2CD1301(D)-(I)C DS-2CD1321(D)-(I)C DS-2CD1321-(I)D				
		DS-1272ZJ-110-TRS Wall mount	DS-1275ZJ-SUS Vertical pole mount	DS-1276ZJ-SUS Corner mount	DS-1280ZJ-S Junction box
		Hik white Aluminum alloy 120×122×169mm 420g	Hik white Stainless Steel 127×46×250mm Diameter of clamp: Ø67-127mm 1205g Match up with wall mount(DS-1272ZJ-110-TRS)	Hik white Stainless Steel 126X105X250mm 2280g Match up with wall mount(DS-1272ZJ-110-TRS)	Hik white Aluminum alloy Ø137 x 53.4x 164.8mm 527g

Product form	Model	Relevant brackets and housings	
Indoor/Outdoor			
	DS-2CD2F22FWD-I(W)S DS-2CD2F42FWD-I(W)S		
		DS-1294ZJ Wall mount	DS-1280ZJ-PT3 Junction box
		Hik white Toughened Plastic 223.9×80×125.8mm 450g	Hik white Plastic Ø120×40mm 104g





Product form	Model	Relevant brackets and housings	
Anti-corrosion Dome	DS-2CD6626DS-IZ(H)S		
		DS-1284ZJ-M Junction box	DS-1703ZJ Wall mount
		Natural Stainless Steel Color Stainless Steel 229×141×71.5mm 1981g	Natural Stainless Steel Color Stainless Steel Ø175.8×116.5×202mm



Product form	Model	Relevant brackets and housings	
Anti-corrosion Dome	DS-2XC6122FWD-IS		
		DS-1705ZJ-DM35 Wall mount	DS-1284ZJ-M Junction box
		Natural Stainless Steel Color Stainless Steel 180×74×150mm	Natural Stainless Steel Color Stainless Steel 229×141×71.5mm 1981g

Product form	Model	Relevant brackets and housings						
Explosion-Proof Camera	DS-2XE6126FWD-HS DS-2XE6146F-HS							
		DS-1694ZJ-X Pendant Mount	DS-1695ZJ-X Wall Mount	DS-1696ZJ-X Pendant Mount-316L	DS-1697ZJ-X Wall Mount-316L	DS-2781ZJ-X Explosion-Proof Terminal Box	DS-2781ZJ-X/316L Explosion-Proof Terminal Box	DS-1677ZJ-XS-1.0 (D) Flexible conduit
		Natural Stainless Steel Color stainless steel 304 φ136*306mm Approx. 1.07 kg	Natural Stainless Steel Color stainless steel 304 136*204.3*353.4 mm Approx. 1.04kg	Natural Stainless Steel Color stainless steel 316L φ136*306mm Approx. 1.07kg	Natural Stainless Steel Color stainless steel 316L 136*204.3*353.4 mm Approx. 1.04kg	Natural Stainless Steel Color DS-2781ZJ-X: stainless steel 304 272 mm × 272 mm × 96.8 mm (10.7 × 10.7 × 3.8) Approx. 6.7 kg (14.8 lb.)	Natural Stainless Steel Color DS-2781ZJ-X/316L: stainless steel 316L 272 mm × 272 mm × 96.8 mm (10.7 × 10.7 × 3.8) Approx. 6.7 kg (14.8 lb.)	NBR, braided steel wire, carbon steel Ø25 mm × 1000 mm

Product form	Model	Relevant brackets and housings	
Anti-corrosion Bullet	DS-2CD6626B-IZ(H)S		
		DS-1701Z Wall mount	DS-1284ZJ-M Junction box
	DS-2CD6652B-IZHS	Natural Stainless Steel Color Stainless Steel 140×228×412.5mm	Natural Stainless Steel Color Stainless Steel 229×141×71.5mm 1981g







Product form	Model	Relevant brackets and housings				
Explosion-Proof Camera	DS-2XE6422F-WD-IZ(H)RS DS-2XE6442F-WD-IZ(H)RS					
		DS-1707ZJ-Y Wall mount	DS-2781ZJ-X Explosion-Proof Terminal Box	DS-2781ZJ-X/316L Explosion-Proof Terminal Box	DS-1707ZJ-Y-E Wall mount (316L stainless steel)	DS-1677ZJ-XS-1.0 (D) Flexible conduit
		Natural Stainless Steel Color SUS316L Stainless Steel 562.5 mm × 180 mm × 309 mm [22.15 × 7.09 × 12.17] 7.02 kg (15.48 lb.)	Natural Stainless Steel Color DS-2781ZJ-X: stainless steel 304 272 mm × 272 mm × 96.8 mm (10.7 × 10.7 × 3.8) Approx. 6.7 kg (14.8 lb.)	Natural Stainless Steel Color DS-2781ZJ-X/316L: stainless steel 316L 272 mm × 272 mm × 96.8 mm (10.7 × 10.7 × 3.8) Approx. 6.7 kg (14.8 lb.)	Natural Stainless Steel Color SUS316L Stainless Steel 562.5 mm × 180 mm × 309 mm [22.15" × 7.09" × 12.17"] 7.02 kg [15.48 lb.]	NBR, braided steel wire, carbon steel Ø25 mm × 1000 mm











Product form	Model	Relevant brackets and housings		
Indoor Dual-lens People Counting Camera	iDS-2CD6810F/C			
		DS-1227ZJ-P1 In-ceiling mount	DS-2102ZJ Wall mount	DS-1299ZJ 302701248
		Hik white Ø253.4×8.5mm	Hik Black 194×110×50mm	Hik white Aluminum Alloy 77×77×198mm 165g



Product form	Model	Relevant brackets and housings
Outdoor Dual-lens people counting camera	iDS-2CD6810F-IV/C	
		DS-1275ZJ-P1 Horizontal pole mount
		Platinum Gray Stainless Steel, and Steel 127 mm × 140.48 mm × 250 mm [5" × 5.53" × 9.84"] 1500 g [3.3 lb.]

Product form	Model	Relevant brackets and housings						
Explosion-proof Bullet	DS-2XE6222F-IS DS-2XE6242F-IS							
		DS-1704Z Wall mount	DS-1706ZJ PT joint	DS-2781ZJ-X Explosion-Proof Terminal Box	DS-2781ZJ-X/316L Explosion-Proof Terminal Box	DS-1704Z-Y Wall mount	DS-1712ZJ Pendant mount	DS-1677ZJ-XS-1.0 (D) Flexible conduit
		Natural Stainless Steel Color Stainless Steel 412.5×140×228mm	Natural Stainless Steel Color Stainless Steel 85×60×55mm	Natural Stainless Steel Color DS-2781ZJ-X: stainless steel 304 272 mm × 272 mm × 96.8 mm (10.7 × 10.7 × 3.8) Approx. 6.7 kg (14.8 lb.)	Natural Stainless Steel Color DS-2781ZJ-X/316L: stainless steel 316L 272 mm × 272 mm × 96.8 mm (10.7 × 10.7 × 3.8) Approx. 6.7 kg (14.8 lb.)	Natural Stainless Steel Color 316L Stainless Steel 412.5×140×228mm	304 stainless steel	NBR, braided steel wire, carbon steel Ø25 mm × 1000 mm

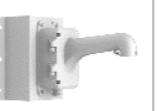
Product form	Model	Relevant brackets and housings				
	DS-2CD6986F-(H)					
		DS-1271ZJ-DM30-E Pendant mount	DS-1605ZJ-DM30 Wall mount	DS-1280ZJ-BQ30 Junction Box	DS-1275ZJ-SUS Vertical pole mount	DS-1276ZJ-SUS Corner mount
		Hik white Aluminum alloy Ø205.6×359mm 1920g	Hik white Aluminum alloy 205.6×183.5×333.6mm 1620g	Hik white Aluminum alloy Ø195×38.5mm	Hikvision White Stainless Steel 127 mm × 46 mm × 250 mm [5" × 1.81" × 9.84"] 1480 g [3.26 lb.] Match up with wall mount(DS-1605ZJ-XX(B))	Hik white Stainless Steel 126X105X250mm 2280g Match up with wall mount(DS-1605ZJ-XX(B))

Product form	Model	Relevant brackets and housings					
PanoVu		Outdoor					
	DS-2CD6D24FWD-I(I)Z(H)(S)/NFC DS-2CD6D54FWD-I(I)Z(H)(S)/NFC						
		DS-1604ZJ	DS-1663ZJ	DS-1661ZJ	DS-1275ZJ-SUS	DS-1276ZJ-SUS	DS-1673ZJ
		Wall Mount with junction box	Ceiling mount	Pendant mount	Vertical pole mount	Corner mount	Horizontal pole mount
		Hik white Aluminum alloy 255×171×355.5mm 2150g	Hik white Aluminum alloy Ø116.5×57mm	Hik white Aluminum alloy Ø116.5×200mm	Hik white Stainless Steel 127×46×250mm Diameter of clamp: Ø67-127mm 1205g	Hik white Stainless Steel 126×105×250mm 2280g	Hik white Steel(mounting board) & Stainless Steel(clamp) Diameter of clamp: Ø67-127mm













Product form	Model	Relevant brackets and housings									
PanoVu Series Panoramic Dome Camera		Outdoor									
	DS-2CD6924F-I(S)/NFC DS-2CD6984G0										
		DS-1661ZJ	DS-1662ZJ	DS-1604ZJ	DS-1604ZJ-pole	DS-1604ZJ-corner	DS-1604ZJ-box	DS-1604ZJ-BOX-POLE	DS-1604ZJ-BOX-CORNER	DS-1602ZJ	
		Pendant mount	Pendant mount	Wall Mount with junction box	Vertical pole mount	Corner mount	Wall mount with junction box	"Vertical Pole Mount with junction box"	Wall Mount with junction box	Wall mount	
		Hik white Aluminum alloy Ø116.5×200mm 600g	Hik white Aluminum alloy Ø116.5×500mm 960g	Hik white Aluminum alloy 255×171×355.5mm 2150g	Hik white Aluminum alloy 170.7×261.8×355.5mm	Hik white Aluminum alloy 206.8×261.8×465mm	Hik white Aluminum alloy 281.2×170.7×395.5mm	Hik white Aluminum alloy & steel 222×139.3×422mm	Hik white Aluminum alloy & steel 255.5×314×542.5mm	Hik white Aluminum alloy 97X182X305mm 1050g	













Product form	Model	Relevant brackets and housings
Underwater Camera	DS-2XC622460-L	 DS-1706ZJ PT joint
	DS-2XC622560-L	Natural Stainless Steel Color Stainless Steel 85×60×55mm

Relevant brackets and housings
 DS-1279ZJ Extendable pole for Pendant mount
Hik white Aluminum alloy 250mm Match up with pendant mount(DS-1271ZJ-XXX, DS-1471ZJ-XXX)

BRACKET PTZ CAMERA

Product form	Model	Relevant brackets and housings	Product form	Model	Relevant brackets and housings	Product form	Model	Relevant brackets and housings
1" Mini Indoor PTZ without IR	DS-2DE1A200(I)W-DE3 DS-2DE1A400(I)W-DE3	Indoor	2.5" Mini Indoor PTZ without IR	DS-2DE2204IW DS-2DE2204IW-DE3/W	Indoor	3" Mini PTZ	DS-2DE3204W-DE DS-2DE3304W-DE	Indoor
					 			   
		DS-1294ZJ-PT Wall Mount			DS-1294ZJ Wall mount DS-1280ZJ-PT3 Junction box			DS-1227ZJ-PT6 In-ceiling mount DS-1273ZJ-PT6 Wall mount DS-1280ZJ-PT6 Junction Box DS-1275ZJ-SUS Vertical pole mount DS-1276ZJ-SUS Corner mount
2.5" Mini Indoor PTZ without IR	DS-2DE2A204(I)W-DE3 DS-2DE2A404(I)W-DE3	Hikvision White Plastic and Steel 223.5 mm × 125.8 mm × 80 mm (8.8" × 4.95" × 3.15") 480 g (1.06 lb.)	DS-2DE2106W-DE3		Hik white Toughened Plastic 223.9×80×125.8mm 450g Hik white Plastic Ø120×40mm 104g			Hik white Steel+Platic Ø210×79.3mm Hik white 183.5×140×232mm Hik white Aluminum alloy 136.5×42×162.5mm 280g Hik white Stainless Steel 127×46×250mm Diameter of clamp: Ø67-127mm 1205g Match up with DS_1273ZJ-PT6

Product form	Model	Relevant brackets and housings													
4 inch PTZ Dome Camera without IR		Outdoor(only available for outdoor PTZ model)													
	DS-2DE4425W-DE DS-2DE4225W-DE DS-2AE4225T-D(C) DS-2AE4215T-D(C)														
		DS-1661ZJ	DS-1662ZJ	DS-1604ZJ	DS-1604ZJ-pole	DS-1604ZJ-corner	DS-1604ZJ-box	DS-1604ZJ-BOX-POLE	DS-1604ZJ-BOX-CORNER	DS-1602ZJ	DS-1602ZJ	DS-1602ZJ	DS-1602ZJ	DS-1602ZJ	DS-1602ZJ
		Pendant mount	Pendant mount	Wall Mount with junction box	Vertical pole mount	Corner mount	Wall mount with junction box	"Vertical Pole Mount with junction box"	Wall Mount with junction box	Wall mount	Wall mount	Wall mount	Wall mount	Wall mount	Wall mount
		Hik white Aluminum alloy Ø116.5×200mm 600g	Hik white Aluminum alloy Ø116.5×500mm 960g	Hik white Aluminum alloy Ø116.5×57mm 380g	Hik white Aluminum alloy 110×145×189mm 550g	Hik white Aluminum alloy 180×950×800mm 2900g	Hik white Aluminum alloy 255×171×355.5mm 2150g	Hik white Aluminum alloy 170.7×261.8×355.5mm	Hik white Aluminum alloy 206.8×261.8×465mm	Hik white Aluminum alloy 281.2×170.7×395.5mm	Hik white Aluminum alloy & steel 222×139.3×422mm	Hik white Aluminum alloy & steel 255.5×314×542.5mm	Hik white Aluminum alloy 455.2×130.4×841.5mm	Hik white Aluminum alloy 97x 182x 305mm	





Product form	Model	Relevant brackets and housings													
4 inch PTZ Dome Camera with IR		Outdoor(only available for outdoor PTZ model)													
	DS-2AE4225T-D(C) DS-2AE4215T-D(C) DS-2DE4425W-DE DS-2DE4415W-DE DS-2DE4225W-DE DS-2DE4215W-DE														
		DS-1661ZJ	DS-1662ZJ	DS-1604ZJ	DS-1604ZJ-pole	DS-1604ZJ-corner	DS-1604ZJ-box	DS-1604ZJ-BOX-POLE	DS-1604ZJ-BOX-CORNER	DS-1602ZJ	DS-1602ZJ	DS-1602ZJ	DS-1602ZJ	DS-1602ZJ	DS-1602ZJ
		Pendant mount	Pendant mount	Ceiling mount	Wall mount(short arm)	Parapet wall mount	Wall Mount with junction box	Vertical pole mount	Corner mount	Wall mount with junction box	Vertical Pole Mount with junction box	Wall Mount with junction box	Gooseneck mount	Wall Mount	In-ceiling mount
		Hik white Aluminum alloy Ø116.5×200mm 600g	Hik white Aluminum alloy Ø116.5×500mm 960g	Hik white Aluminum alloy Ø116.5×57mm 380g	Hik white Aluminum alloy 110×145×189mm 550g	Hik white Aluminum alloy 180×950×800mm 2900g	Hik white Aluminum alloy 255×171×355.5mm 2150g	Hik white Aluminum alloy 170.7×261.8×355.5mm	Hik white Aluminum alloy 206.8×261.8×465mm	Hik white Aluminum alloy 281.2×170.7×395.5mm	Hik white Aluminum alloy & steel 222×139.3×422mm	Hik white Aluminum alloy & steel 255.5×314×542.5mm	Hik white Aluminum alloy 455.2×130.4×841.5mm	Hik white Aluminum alloy 97x 182x 305mm	Hik Black Steel + plastic Ø232.9×142.6mm





Product form	Model	Relevant brackets and housings												
		Outdoor(only available for outdoor PTZ model)												
5 inch with IR	DS-2DE5432IW-AE DS-2DE5425IW-AE DS-2DE5232IW-AE DS-2DE5225IW-AE DS-2AE5232TI-A (C) DS-2AE5225TI-A (C)													
5 inch with-out IR	DS-2DF5232X-AEL DS-2DF5225X-AEL	Pendant mount	Pendant mount	Ceiling mount	Parapet wall mount	Wall mount	Vertical pole mount	Corner mount	Wall mount with junction box	Vertical Pole Mount with junction box	Wall Mount with junction box	Gooseneck mount	Extendable pole for Pendant mount	Wall Mount
7 inch with IR	DS-2DE5425W-AE DS-2DE5330W-AE DS-2DE5320W-AE DS-2DE5232W-AE DS-2DE5225W-AE DS-2AE5232T-A (C) DS-2AE5232T-A3 (C) DS-2AE5225T-A (C) DS-2AE5225T-A3 (C)													
6 inch	DS-2DE7A225MX-AE DS-2DE7A232MX-AE	Hik white Aluminum alloy Ø116.5×200mm 600g	Hik white Aluminum alloy Ø116.5×500mm 960g	Hik white Aluminum alloy Ø116.5×57mm 380g	Hik white Aluminum alloy 180×950× 800mm 2900g	Hik white Aluminum alloy 255×171× 355.5mm 2150g	Hik white Aluminum alloy 170.7×261.8× 355.5mm	Hik white Aluminum alloy 206.8×261.8× 465mm	Hik white Aluminum alloy 281.2×170.7× 395.5mm	Hik white Aluminum alloy & steel 222×139.3× 422mm	Hik white Aluminum alloy & steel 255.5×314× 542.5mm	Hik white Aluminum alloy 455.2×130.4× 841.5mm	Hik white Galvanized steel pipe 1500-2500mm	Hik white Aluminum alloy 97X182X- 305mm
8 inch	DS-2DF8836IX-AEL DS-2DF8836IX-AELW DS-2DF8825IX-AEL DS-2DF8825IX-AELW DS-2DF8436IX-AEL DS-2DF8436IX-AELW DS-2DF8425IX-AEL DS-2DF8425IX-AELW DS-2DF8236IX-AEL DS-2DF8236IX-AELW DS-2DF8225IX-AEL DS-2DF8225IX-AELW													
Traffic PTZ	iDS-2VS235-F836													
Laser IR PTZ	DS-2DF8836ISX-AELW DS-2DF8436ISX-AELW DS-2DF8236ISX-AELW DS-2DF8250ISX-AEL DS-2DF8250ISX-AELW DS-2DF8250ISX-AELW													

Product form	Model	Relevant brackets and housings							
		Indoor							
	DS-2DE4A220IW-DE DS-2DE4A320IW-DE								
		DS-1605ZJ Wall Mount Bracket	DS-1671ZJ-SD11 In-ceiling Mount Bracket	DS-1280ZJ-SD11 Junction Box	DS-1691ZJ-L Pendant mount	DS-1691ZJ-M Pendant mount	DS-1691ZJ Pendant mount	DS-1275ZJ-SUS Vertical pole mount	DS-1276ZJ-SUS Corner mount
		Hik white Aluminum alloy 183.5×120×228.6mm 1120g	Hik white Aluminum alloy Ø233×85mm	Hik white Aluminum alloy Ø158×40mm	Hik white Steel 124×84×1000mm 2175g	Hik white Steel 124×84×500mm 1175g	Hik white Aluminum alloy 84×124×335mm 980g	Hik white Stainless Steel 127×46×250mm Diameter of clamp: Ø67- 127mm 1205g Match up with DS_1605ZJ	Hik white Stainless Steel 126×105×250mm 2280g Match up with DS_1605ZJ

Product form	Model	Relevant brackets and housings													
		Outdoor													
DarkFighterX PTZ camera	DS-2DF8225IH-AEL(W)														
6A series PTZ Dome Camera	DS-2DF6A836X-AEL DS-2DF6A825X-AEL DS-2DF6A436X-AEL DS-2DF6A425X-AEL DS-2DF6A236X-AEL DS-2DF6A225X-AEL	Wall Mount with junction box	Ceiling mount	Parapet wall mount	Pendant mount	Extendable pole for Pendant mount	Ceiling mount	Extendable pole for Pendant mount	Pendant mount	Horizontal pole mount	Vertical pole mount	Corner mount	Wall mount with junction box	Wall Mount with junction box	Vertical Pole Mount with junction box
8A series PTZ Dome Camera	DS-2DF8A425I(N) X-AEL DS-2DF8A436I(N) X-AEL DS-2DF8A825I(N) X-AEL DS-2DF8A836I(N) X-AEL	Platinum gray Aluminum alloy 255×171× 355.5mm 2150g	Platinum gray Aluminum alloy Ø116.5×57mm 380g	Platinum gray Aluminum alloy 180×950× 800mm 2900g	Platinum gray Aluminum alloy Ø116.5× 200mm 600g	Platinum gray Galvanized steel pipe 1500- 2500mm	Platinum gray Aluminum alloy Ø116.5×57mm 380g	Platinum gray Aluminum alloy 500mm Match up with pendant mount(DS-1661ZJ-P)	Platinum gray Aluminum alloy Ø116.5× 500mm 960g	Platinum gray Steel(mounting board) & Stainless Steel(clamp) Diameter of clamp: Ø67- 127mm Match up with pendant mount*	Platinum gray Aluminum alloy 170.7×261.8× 355.5mm	Platinum gray Aluminum alloy 206.8×261.8× 465mm	Platinum gray Aluminum alloy 281.2×170.7× 395.5mm	Platinum gray Aluminum alloy & steel 255.5×314× 542.5mm	Platinum gray Aluminum alloy & steel 222×139.3× 422mm









Product form	Model	Relevant brackets and housings				
		Outdoor				
9C series PTZ Dome Camera	DS-2DF9C245IH-DLW DS-2DF9C435IH-DLW					
		DS-1603ZJ-P Wall mount	DS-1668ZJ-P Pendant mount	DS-1668ZJ(20)-P Pendant mount	DS-1603ZJ-Pole-P Vertical Pole Mount	DS-1619ZJ-HP2 Gooseneck Mount
		Platinum Gray Aluminum Alloy 364.1 mm × 182.0 mm (14.3" × 7.2") 1400 g (3.09 lb.)	Platinum Gray Steel Ø115×58mm 620g	Platinum Gray Steel Ø 115 mm × 200 mm (4.53" × 7.87") 1150 g (2.54 lb.)	Platinum Gray Aluminum Alloy+steel 410.6×194×126.1 mm 2.5Kg	Platinum Gray Stainless Steel Ø 130 mm × 455 mm × 526 mm (5.12" × 17.91" × 20.71") 5200 g (12.46 lb.)

Product form	Model	Relevant brackets and housings			
Indoor PTZ		Indoor			
	DS-2DF5220-D4 DS-2DF5220S-DE4/W				
		DS-1691ZJ Pendant mount	DS-1695ZJ Integrated wall mount	DS-1691ZJ-L Pendant mount	DS-1691ZJ-M Pendant mount
		Hik white Aluminum alloy 84×124×335mm 980g	Hik white Aluminum alloy + Plastic 157×86×246mm	Hik white Steel 124×84×1000mm 2175g	Hik white Steel 124×84×500mm 1175g







Product form	Model	Relevant brackets and housings		
PanoVu PT		Outdoor		
	iDS-2PT9122IX-DE/S Wall mount bracket included in the package			
		DS-2664ZJ Pendant mount	DS-2601ZJ-P Wall Mounting Bracket[INCL-ED]	DS-2665ZJ-P Base Mounting Bracket
		Gray Aluminum alloy Ø203.5×217.4mm	Plastic with surface spray treatment Ø203.5 mm × 227.9 mm	Plastic with surface spray treatment 178.7 mm × 126 mm × 57.2 mm



Product form	Model	Relevant brackets and housings						
PanoVu		Outdoor						
	DS-2DP0818Z-D DS-2DP1636Z-D							
		DS-1603ZJ Wall mount	DS-1668ZJ Pendant mount	DS-1668ZJ(20) Pendant mount	DS-1673ZJ Horizontal pole mount	DS-1684ZJ Vertical Pole mount	DS-1678ZJ Junction Box	DS-1619ZJ-H2 Gooseneck Mount
		Hik white Aluminum alloy 98×182×362mm	Hik white Steel Ø115×58mm 620g	Hik white Steel Ø115×200mm 1150g	Hik white Steel(mounting board) & Stainless Steel(clamp) Diameter of clamp: Ø67- 127mm Match up with pendant mount	Hik white Steel(mounting board) & Stainless Steel(clamp) Diameter of clamp: Ø67- 127mm Match up with Wall mount	Hik white Aluminum alloy 286×424×119.5mm	Hik white Stainless Steel Ø130 mm × 455 mm × 526 mm (5.12" × 17.91" × 20.71") 5200 g (12.46 lb.)

Product form	Model	Relevant brackets and housings	
Mini PanoVu Series		Indoor	
	DS-2PT3326IZ-DE3 DS-2PT3122IZ-DE3		
		DS-1294ZJ-TRL Wall Mount	DS-1271ZJ-PT10 Pendant Mount
	DS-2PT3306IZ-DE3	Hik white PC+ABS	Hik white Aluminum Alloy and Plastic Ø160.6 mm × 532 mm (6.32 × 20.9) 1300 g (2.87 lb.)







Product form	Model	Relevant brackets and housings					
Mini PanoVu Series		Outdoor					
	DS-2PT5326IZ-DE						
		DS-1604ZJ Wall Mount with junction box	DS-1604ZJ-pole Vertical pole mount	DS-1604ZJ-corner Corner mount	DS-1661ZJ Pendant mount	DS-1619ZJ-H2 Gooseneck Mount	DS-1602ZJ Wall Mount
	DS-2PT5306IZ-DE DS-2PT5306BZ-DE	Hik white Aluminum alloy 255×171×355.5mm 2150g	Hik white Aluminum alloy 170.7×261.8× 355.5mm	Hik white Aluminum alloy 206.8×261.8× 465mm	Hik white Aluminum alloy Ø116.5×200mm 600g	Hik white Stainless Steel Ø130 mm × 455 mm × 526 mm (5.12" × 17.91" × 20.71") 5200 g (12.46 lb.)	Hik white Aluminum alloy 97×182×305mm

Product form	Model	Relevant brackets and housings								
PanoVu		Outdoor								
	DS-2DP1636-D									
		DS-1603ZJ Wall mount	DS-2663ZJ 3-axis Mount	DS-1668ZJ Pendant mount	DS-1668ZJ(20) Pendant mount	DS-1673ZJ Horizontal pole mount	DS-1684ZJ Vertical Pole mount	DS-1678ZJ Junction Box	DS-1619ZJ-H2 Gooseneck Mount	DS-2663ZJ 3-axis Mount
		Hik white Aluminum alloy 98×182×362mm	Hik white Aluminum alloy 275.8×269×140.1mm 2600g	Hik white Steel Ø115×58mm 620g	Hik white Steel Ø115×200mm 1150g	Hik white Steel(mounting board) & Stainless Steel(- clamp) Diameter of clamp: Ø67-127mm Match up with pendant mount	Hik white Steel(mounting board) & Stainless Steel(- clamp) Diameter of clamp: Ø67-127mm Match up with Wall mount	Hik white Aluminum alloy 286×424×119.5mm	Hik white Stainless Steel Ø130 mm × 455 mm × 526 mm (5.12" × 17.91" × 20.71") 5200 g (12.46 lb.)	Hik white Aluminum alloy 275.8×269×140.1mm 2600g







Product form	Model	Relevant brackets and housings				
PanoVu		Outdoor				
	DS-2DP1636IZIX-D/236					
		DS-1603ZJ-P Wall mount	DS-1668ZJ-P Pendant mount	DS-1668ZJ(20)-P Pendant mount	DS-1603ZJ-Pole-P Vertical Pole Mount	DS-1619ZJ-HP2 Gooseneck Mount
	DS-2DP0818IZIX-D DS-2DP0818ZX-D(B) DS-2DP1636ZX-D(B) DS-2DP1636IZIX-D(B) DS-2DP0818IZIX-D(B)	Platinum Gray Aluminum Alloy 364.1 mm × 182.0 mm (14.3 × 7.2) 1400 g (3.09 lb.)	Platinum Gray Steel Ø115×58mm 620g	Platinum Gray Steel Ø115 mm × 200 mm (4.53 × 7.87) 1150 g (2.54 lb.)	Platinum Gray Aluminum Alloy+steel 410.6×194×126.1 mm 2.5kg	Platinum Gray Stainless Steel Ø130 mm × 455 mm × 526 mm (5.12" × 17.91" × 20.71") 5200 g (12.46 lb.)

Product form	Model	Relevant brackets and housings	
Anti-corrosion PTZ		Outdoor	
	DS-2DT6223-AEL		
		DS-1696ZJ-Y Pendant mount	DS-1697ZJ-Y Wall mount
		Stainless steel 316L 160×160×342mm 1890g	Stainless steel 316L 136×212×326mm 2300g

Product form	Model	Relevant brackets and housings		
Anti-corrosion PTZ		Outdoor		
	DS-2DF8236IX-AELWY			
		DS-1602ZJ-AKS Wall mount	DS-1604ZJ-BOX-Corner-Y Corner Pole Mount with junction box	DS-1604ZJ-BOX-Y Wall mount with junction box
		Stainless steel material with surface spray treatment 97×182×305mm 1050g	Stainless steel material with surface spray treatment 255.5×314×542.5mm	Stainless steel material with surface spray treatment Aluminum alloy 281.2×170.7×395.5mm







Product form	Model	Relevant brackets and housings				
Explosion-proof		Outdoor				
	DS-2DF6223-CX(W) DS-2DF6223-CX(W/316L) wall mount bracket included in the package					
		DS-1691ZJ-X Pendant Mounting	DS-1690ZJ-X Wall mounting bracket (included)	DS-1677ZJ-XS-1.0 (C2) Flexible conduit	DS-2780ZJ-X Explosion-proof terminal box	DS-1677ZJ-XS-1.0 (D) Flexible conduit
		Stainless steel 304L 250 mm × 200 mm × 303 mm 6 kg	SUS304 stainless steel 350 mm × 227.5 mm × 345.5 mm 7 KG	NBR, braided steel wire, carbon steel Ø25 mm × 1000 mm	stainless steel 272 mm × 272 mm × 96.8 mm 6.4 kg	NBR, braided steel wire, carbon steel Ø25 mm × 1000 mm



Product form	Model	Relevant brackets and housings					
Explosion-proof Zoom Bullet Camera		Outdoor					
	DS-2DB4223I-CX(WE)						
		DS-1707ZJ-E Wall mount	DS-1707ZJ Wall mount	DS-1677ZJ-XS-1.0 (D) Flexible conduit	DS-2780ZJ-X Explosion-proof terminal box	DS-1708ZJ PT joint	DS-1677ZJ-XS-1.0 (D) Flexible conduit
		{304 stainless steel} 562.5 mm × 180 mm × 309 mm 7.02 kg	{304 stainless steel} 543.5 mm × 160 mm × 258 mm 4.98 kg	NBR, braided steel wire, carbon steel Ø25 mm × 1000 mm	stainless steel 272 mm × 272 mm × 96.8 mm 6.4 kg	{304 stainless steel}	NBR, braided steel wire, carbon steel Ø25 mm × 1000 mm

Product form	Model	Relevant brackets and housings				
Explosion-proof Zoom Bullet Camera		Outdoor				
	DS-2DB4223I-CX(WE/316L) DS-2DB4236I-CWX(WE/316L)					
		DS-1707ZJ-E Wall mount	DS-1707ZJ Wall mount	DS-1677ZJ-XS-1.0 (D) Flexible conduit	DS-2780ZJ-X Explosion-proof terminal box	DS-1677ZJ-XS-1.0 (D) Flexible conduit
		{304 stainless steel} 562.5 mm × 180 mm × 309 mm 7.02 kg	{304 stainless steel} 543.5 mm × 160 mm × 258 mm 4.98 kg	NBR, braided steel wire, carbon steel Ø25 mm × 1000 mm	stainless steel 272 mm × 272 mm × 96.8 mm 6.4 kg	NBR, braided steel wire, carbon steel Ø25 mm × 1000 mm

Product form	Model	Relevant brackets and housings		
Zoom camera		Indoor	Housing	
	DS-2ZCA2304P(N) DS-2ZCA3604P(N)			
		DS-1299ZJ Pendant Mount	DS-1292ZJ Wall mount	DS-1331HZ -CZ Outdoor housing
	DS-2DZ21xx series DS-2ZCNXXXX series	Hik white Aluminum Alloy 77×77×198mm 165g	Hik white Aluminum alloy 70×97.1× 217.9mm 201g	Hik white Aluminum alloy

BRACKET POSITIONING

Product form	Model	Relevant brackets and housings	
Positioning System		Outdoor	
	DS-2DY9250IAX-A DS-2DY9236I8X-A DS-2DY9188-AI8 DS-2DY9187-AI8		
		DS-1693ZJ Wall mount	DS-1678ZJ Junction Box
	DS-2DY9236IX-A DS-2DY9188-AI2 DS-2DY9185-AI2	Hik white steel 190×200×500mm 5700g	Hik white Aluminum alloy 286×424×119.5mm
	DS-2DY9250X-A DS-2DY9236X-A DS-2DY9188-A DS-2DY9185-A		
	DS-2DY7236W-A DS-2DY7236IW-A		





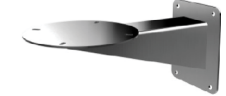







Product form	Model	Relevant brackets and housings
Positioning System Lite		Outdoor
	DS-2DY5223IW-AE	
		DS-1693ZJ-S Wall mount
		Hik white steel 167×182×309mm 2330g

















Product form	Model	Relevant brackets and housings		
PT Bullet Camera		Outdoor		
	DS-2DY3320IW-DE DS-2DY3220IW-DE			
		DS-1280ZJ-M[SPTZ] Junction Box	DS-1281ZJ-M[SPTZ] Inclined ceiling mount	DS-1275ZJ[SPTZ] Pole mount
		Hik white steel 157 x 53.4 x 184mm 621g	Hik white steel 157 x 61.8 x 165.7mm 586g	Hik white steel 250 x 127 x 140mm

Product form	Model	Relevant brackets and housings
Explosion-Proof Positioning System		Outdoor
	DS-2DY9236I-CWX(W/316L)	
		DS-1713ZJ-Y [SUS316L] Wall Mounting Bracket
		Natural Stainless Steel Color SUS316L Ø 270 mm × 479 mm × 235 mm (Ø 10.63 × 18.86 × 9.25) 7.1 kg (15.65 lb.)

BRACKET

HOUSING





Key feature	Model	Relevant brackets			Key feature	Model	Relevant brackets					Key feature	Model	Relevant brackets
 Hik white Complex fiber 290×142×92mm 640g	DS-1330HZ					DS-4718HZ-K							DS-1340HZ	
 Hik white Aluminum alloy 288×149×100mm 800g	DS-1332HZ	DS-1293ZJ Wall mount	DS-1299ZJ Pendant Mount	DS-1269ZJ Pendant mount	Hik white Aluminum alloy 88×116.6× 297.3mm 473g	Hik white Aluminum Alloy 77×77×198mm 165g	Hik white Aluminum alloy 493×246× 88mm 480g	Hik white Steel(mount- ing board) & Stainless Steel(clamp) 117×226× 194mm Diameter of clamp: Ø67- 127mm 1205g Match up with wall mount(DS- 1293ZJ)	Hik white Steel(mount- ing board) & Stainless Steel(clamp) 117×226× 194mm Diameter of clamp: Ø67- 127mm 1205g Match up with wall mount(DS- 1293ZJ)	Hik white Steel(mount- ing board) & Stainless Steel(clamp) 117×226× 194mm Diameter of clamp: Ø67- 127mm 1205g Match up with wall mount(DS- 1293ZJ)	Hik white Stainless Steel 127×46×25 0mm Diameter of clamp: Ø67- 127mm 1205g Match up with wall mount(DS- 1293ZJ)	Three-axis adjustment Containing combined wires and fan IK10	DS-1275ZJ-4626 Vertical Pole Mount	Hik white, Steel(mounting board) & Stainless Steel(clamp) 127×46×250mm 1235g For 5 series box camera















Key feature	Model	Key feature	Model	Relevant brackets																
 Hik white Aluminum alloy Containing fan DC12V IP67 110×165×445mm 1900g	DS-1331HZ-C	 Hik white Aluminum alloy Containing fan DC12V IP67 IK10 445×140×94mm 1900g	DS-1331HZ-CE	Outdoor																
 Hik white Aluminum alloy Containing fan and heater AC24V IP67 110×165×445mm 1900g	DS-1331HZ-H	 Hik white Aluminum alloy Containing fan and heater DC12V IP67 IK10 445×140×94mm 1900g	DS-1331HZ-CI									DS-1293ZJ	DS-1269ZJ	DS-1214ZJ	DS-1214ZJ-T	DS-1233ZJ	DS-1232ZJ	DS-1232ZJ-T	DS-1275ZJ-SUS	
 Hik white Aluminum alloy Containing fan and wiper AC24V IP67 445×165×170mm 1900g	DS-1331HZ-W	 Hik white Aluminum alloy Containing fan and heater AC 24V(DC 12V) IP67 IK10 110×165×445mm 1900g	DS-1331HZ-HI	Wall mount	Pendant mount	Horizontal pole mount	Horizontal pole mount	Column Mount	Cardan Joint	Cardan Joint	Vertical pole mount	Hik white Stainless Steel 127×46× 250mm Diameter of clamp: Ø67- 127mm 1205g Match up with wall mount(DS- 1293ZJ)	Hik white Aluminum alloy 88×116.6× 297.3mm 473g	Hik white Aluminum alloy 493×246× 88mm 480g	Hik white Steel(mount- ing board) & Stainless Steel(clamp) 117×226× 194mm Diameter of clamp: Ø67- 127mm 1895g	Hik white Steel Ø160 x 1093mm 6200g	Hik white Steel 126x103.5x 83mm 790	Hik white Steel 96x95x92.5mm	Hik white Stainless Steel 127×46× 250mm Diameter of clamp: Ø67- 127mm 1205g Match up with wall mount(DS- 1293ZJ)	
 Hik white Aluminum alloy Containing fan, wiper and heater AC24V IP67 445×165×170mm 2500g	DS-1331HZ-HW	 Hik white Aluminum alloy Containing fan and heater AC 24V(DC 12V) IP67 suitable for wide angle lens and fish-eye lens 454.2×169.2×114.6mm 1900g	DS-1331HZ-HI	Hik white Aluminum alloy Containing fan and heater AC 110 to 240V IP66 490×169.4×100mm 3200g	DS-1331HZ-R	Wall mount	Pendant mount	Horizontal pole mount	Horizontal pole mount	Column Mount	Cardan Joint	Vertical pole mount	Hik white Stainless Steel 127×46× 250mm Diameter of clamp: Ø67- 127mm 1205g Match up with wall mount(DS- 1293ZJ)	Hik white Aluminum alloy 88×116.6× 297.3mm 473g	Hik white Aluminum alloy 493×246× 88mm 480g	Hik white Steel(mount- ing board) & Stainless Steel(clamp) 117×226× 194mm Diameter of clamp: Ø67- 127mm 1895g	Hik white Steel Ø160 x 1093mm 6200g	Hik white Steel 126x103.5x 83mm 790	Hik white Steel 96x95x92.5mm	Hik white Stainless Steel 127×46× 250mm Diameter of clamp: Ø67- 127mm 1205g Match up with wall mount(DS- 1293ZJ)

BRACKET

THERMAL ACCESSORIES

Product form	Relevant brackets						
							
DS-2TD1217V1	DS-1273ZJ-130-TRL Wall mount	DS-1275ZJ-SUS Vertical pole mount	DS-1276ZJ-SUS Corner mount	DS-1280ZJ-M Junction box	DS-1281ZJ-M Inclined ceiling mount	DS-1271ZJ-130-TRL Pendant mount	DS-1273ZJ-130B-TRL Wall mount
	Hik white Aluminum alloy 131×183.5×228.5mm 890g	Hikvision White Stainless Steel 127 mm × 46 mm × 250 mm (5" × 1.81" × 9.84") 1480 g (3.26 lb.) Match up with wall mount(DS- 1273ZJ-XX(B))	Hik white Stainless Steel 126X105X250mm 2280g Match up with wall mount(DS- 1273ZJ-XX(B))	Hik white Aluminum alloy 157×184.8×53.4mm 621g	Hik white Aluminum alloy 157×165.7×61.8mm 586g	Hikvision white Aluminum alloy Ø150×567mm	Hikvision White Aluminum Alloy Ø 132 mm × 242.9 mm × 288.5mm (5.20" × 9.56" × 11.36") 1690 g (3.73 lb.)

Product form	Relevant brackets			
				
DS-2TD2136V1/2166V1/2117V1	DS-2TD2615/2636/2617V1	DS-1275ZJ Vertical pole mount	DS-1276ZJ Corner mount	DS-1260ZJ Junction box
		Hik white Stainless steel 117×143×195mm	Hik white Stainless steel 158X173mm	Hik white wwwAluminum alloy Ø88.5 mm

Product form	Relevant brackets														
															
DS-2TD41XX	DS-1602ZJ Wall mount	DS-1602ZJ-pole Vertical pole mount	DS-1602ZJ-corner Corner mount	DS-1604ZJ-box Wall mount, Including power box	DS-1604ZJ- BOX-POLE Vertical Pole Mount with junction box	DS-1604ZJ- BOX-CORNER Wall Mount with junction box	DS-1673ZJ Vertical pole mount	DS-1619ZJ Gooseneck mount	DS-1661ZJ Pendant mount	DS-1662ZJ Pendant mount	DS-1667ZJ Extendable pole for Pendant mount	DS-1682ZJ Extendable pole for Pendant mount	DS-1663ZJ Ceiling mount	DS-1660ZJ Parapet wall mount	
	Hik white Aluminum alloy 97×182×305mm	Hik white Aluminum alloy 117×194× 310mm	Hik white Aluminum alloy 176.8×194× 419.5mm	Hik white Aluminum alloy 281.2×170.7× 395.5mm	Hik white Aluminum alloy 222×139× 422mm	Hik white Aluminum alloy 255×314× 542mm	Hik white Stainless steel Ø67-127mm	Hik white Aluminum alloy 455.2×130.4× 841.5mm	Hik white Aluminum alloy Ø116.5×200mm	Hik white Aluminum alloy Ø116.5×500mm	Hik white Galvanized steel pipe 1500-2500mm	Hik white Aluminum alloy Ø116.5×500mm	Hik white Aluminum alloy Ø116.5×57mm	Hik white Aluminum alloy Ø180×950× 800mm	

PRO & VALUE SERIES QUICK GUIDE

2020 H1

Hikvision Europe

Dirk Storklaan 3
2132 PX Hoofddorp
The Netherlands
T +31 23 5542770
info.eu@hikvision.com

Hikvision France

6 rue Paul Cézanne,
93360 Neuilly-Plaisance
France
T +33 (0)1 85330450
info.fr@hikvision.com

Hikvision Poland

The Park, Office Building A
Krakowiaków 50
02-255 Warsaw, Poland
T +48 22 4600150
info.pl@hikvision.com

Hikvision Czech

BETA Building, Vyskocilova
1481/4, Prague 4
Czech Republic
T +42 29 6182640
info.cz@hikvision.com

Hikvision Germany

Werner-Heisenberg Str. 2b
63263 Neu-Isenburg,
Germany
T +49 69 401507290
sales.dach@hikvision.com

Hikvision Romania

Splaiul Independentei street
291-293, Riverside Tower, 12th
floor, 6th district,
Bucharest, Romania
T +31235542770/988
marketing.ro@hikvision.com

Hikvision Belgium

Neringenweg 44,
3001 Leuven, Belgium
T +31 23 5542770
info.bnl@hikvision.com

Hikvision Hungary

Budapest, Reichl Kálmán u. 8,
1031, Hungary
T +36 1 323 7650
info.hu@hikvision.com

01/2020



HIKVISION
www.hikvision.com